

Fundamentals of Algebro-Projective Photogrammetry

By

G. Brandstätter

(Vorgelegt in der Sitzung der math.-nat. Klasse am 7. März 1996
durch das w. M. Helmut Moritz)

Motivation

After 70 years of analogous photogrammetry by means of ingenious sophisticated optomechanical instruments and 20 years of analytical photogrammetry based on automatic stereocomparators which were controlled by fast electronic central processors and linked host computers, digital photogrammetry increasingly became the only method currently used. Digital photogrammetry – sometimes also called “Soft Copy Photogrammetry” – processes digitized stereo images which are viewed by special devices for spatial impression such as, for example, stereoscopes. Other possibilities are the ancient method of anaglyphic representation by means of red and green glasses or the currently used method of shutter glasses controlled by an infrared transmitter synchronized with the half linefrequency of the computer display and hence with the change between left and right image.

All photogrammetric images of the analogous method were strictly restricted to the use of metric (i.e. calibrated) cameras with well-defined focal lengths and centered cartesian image coordinates achieved by means of most accurately calibrated fiducial marks (= interior orientation) in the image. In “Analytical Plotters”, in principle, arbitrary (analogous) images can be used, but as the evaluation must be controlled visually by human operators, the images must be taken with equal focal lengths and at

approximately equal scales. “Digital Photogrammetry” depends on an accurate external digitizer, i.e. a drum or flat scanner with optimum resolution and free of additional radiometric or geometric errors. All the other photogrammetric tasks are performed on a fast micro computer or – more conveniently – on a special graphical workstation. The operating programs are similar to those of analytical plotters, but as digital images may be transformed projectively to any other direction of exposure and any scale, they may have different focal lengths and do not require image coordinates referred to the optical axis. Moreover, image coordinates measured by the comparators of analytical plotters or by means of scanners cannot be expected to be of cartesian type. In general, they result from a measuring device with at least small obliquities between the coordinate axes and small differences in scale along them. Hence, for the purpose of simulating ideal conditions, i.e. cartesian image coordinates, the measuring unit must be calibrated, too.

Very often it is more expedient to accept the fact that in reality all image coordinates are oblique and heterometric, or in one word, *affine*. In this case, the working methods of photogrammetry must be adapted to coordinate systems which refer to object points defining a three-dimensional affine space, and to corresponding plane affine coordinate systems in the image, referring to the projections of those so-called *basic points*. Therefore, the theoretical presuppositions are quite different to the ones used in traditional analytical photogrammetry, which refer to strict cartesian systems defined outside the model or image spaces, and they should be distinguished in order to indicate their independence of all prevailing postulations. The new name “*algebra-projective*” may be considered somewhat complicated but it takes into account that all tasks of the following developments can be solved rigorously by means of *linear algebra* based on elements of *projective geometry*, in opposition to analytical photogrammetry, where nearly all calculations must use iterative procedures due to the highly non-linear character of their basic relations.

1. Foundation of Algebra-Projective Photogrammetry

1.1. Projection from Space to Plane (Singular Projective Transformation)

By introducing a general affine coordinate system in a tridimensional (vector) space V^3 with inhomogeneous point coordinates $\mathbf{y}^T = (y_1, y_2, y_3)$, the position of an image plane P^2 can be defined by means of a center of projection \mathbf{y}_0 and three points $(\mathbf{y}_0 + \mathbf{b}_j)$, $j = 0, 1, 2$, of the plane (Fig. 1.1/1a). This definition is essentially more general than the usual one based on center of projection \mathbf{X}_0 , normal vector \mathbf{k} and normal

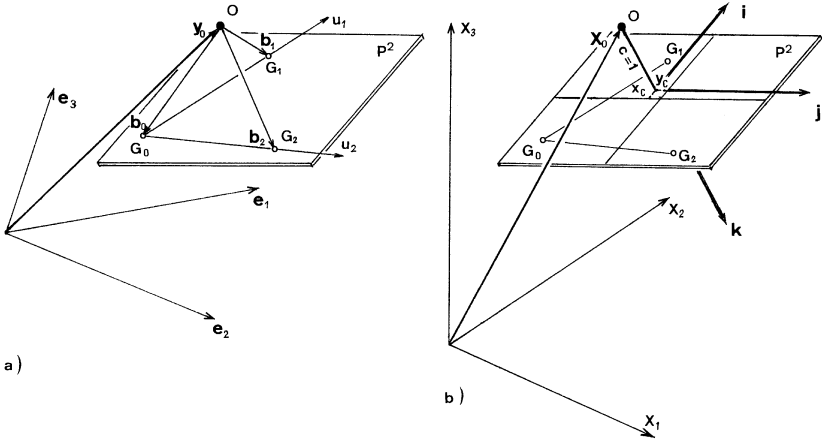

Fig. 1.1/1. Possibilities of imaging geometries

distance c (Fig. 1.1/1b) of analytic photogrammetry [15] with orthonormalized (cartesian) coordinates. In order to get the projection of any point \mathbf{y} of V^3 onto P^2 , the vector $\mathbf{z} = \mathbf{y} - \mathbf{y}_0$ must be transformed into the system of the three “base vectors” \mathbf{b}_j by introducing three numbers x^j , so that

$$\mathbf{z} = x^0 \mathbf{b}_0 + x^1 \mathbf{b}_1 + x^2 \mathbf{b}_2 \tag{1.1.1}$$

or in matrix notation

$$\begin{bmatrix} b_{00} & b_{01} & b_{02} \\ b_{01} & b_{11} & b_{21} \\ b_{02} & b_{12} & b_{22} \end{bmatrix} \begin{bmatrix} x^0 \\ x^1 \\ x^2 \end{bmatrix} = \mathbf{B} \mathbf{x} \tag{1.1.2}$$

[7]. \mathbf{x} is the vector of affine coordinates related to the “base” \mathbf{b}_j and (1.1.1) is the equation of reconstruction. The equation of projection

$$\mathbf{x} = \mathbf{B}^* \mathbf{z}$$

results from the inversion of \mathbf{B} according to

$$\begin{bmatrix} b_0^0 & b_1^0 & b_2^0 \\ b_0^1 & b_1^1 & b_2^1 \\ b_0^2 & b_1^2 & b_2^2 \end{bmatrix} \begin{bmatrix} b_{00} & b_{10} & b_{20} \\ b_{01} & b_{11} & b_{21} \\ b_{02} & b_{12} & b_{22} \end{bmatrix} = \begin{bmatrix} 1 & 0 & 0 \\ 0 & 1 & 0 \\ 0 & 0 & 1 \end{bmatrix},$$

yielding with $D = \det(\mathbf{B})$, $i = j - 1$, $k = j + 1$, $j = 0, 1, 2$, i and k cyclic the row-vectors of \mathbf{B}^*

$$\begin{aligned} \begin{bmatrix} b_0^j \\ b_1^j \\ b_2^j \end{bmatrix} &= \frac{(-1)^i}{D} \begin{bmatrix} b_{k1} b_{i2} - b_{k2} b_{i1} \\ b_{k2} b_{i0} - b_{k0} b_{i2} \\ b_{k0} b_{i1} - b_{k1} b_{i0} \end{bmatrix} = \frac{(-1)^j}{D} \begin{bmatrix} b_{k0} \\ b_{k1} \\ b_{k2} \end{bmatrix} \times \begin{bmatrix} b_{i0} \\ b_{i1} \\ b_{i2} \end{bmatrix} \\ &= \frac{(-1)^j}{D} \mathbf{b}_k \times \mathbf{b}_i = \mathbf{b}^j \quad (1.1.3) \end{aligned}$$

which are the reciprocal vectors of the \mathbf{b}_i [6] and \mathbf{B}^* is the contravariant tensor of the co-variant tensor \mathbf{B} . These relations show, by the way, that the cross product of two vectors is also significant in affine coordinate systems.

Because of

$$\mathbf{b}_j \cdot \mathbf{b}^j = 1 \quad \text{and} \quad \mathbf{b}_j \cdot \mathbf{b}^k = 0$$

the x^j follow from (1.1.1) as

$$x^j = \mathbf{b}^j \cdot \mathbf{z}.$$

Thus they are the contravariant coordinates of \mathbf{z} related to the base $B(\mathbf{b}_i)$. Referring to the following explanations, these relations are not very essential, but they evidently show the connexion of algebro-projective photogrammetry with linear algebra and projective geometry.

In the systems of the base the projection of the point \mathbf{y} is obtained by intersection of \mathbf{z} and P^2 , yielding the spatial point $\mu\mathbf{p} = \mathbf{z}$ (Fig. 1.1/2). Its image coordinates in P^2 arise by means of the basic points G_0, G_1, G_2 , defining an affine system with the units

$$\mathbf{e}_1 = (\mathbf{b}_1 - \mathbf{b}_0) \quad \text{and} \quad \mathbf{e}_2 = (\mathbf{b}_2 - \mathbf{b}_0),$$

where the image point is fixed by the vector equation

$$\mathbf{p} - \mathbf{b}_0 = u_1(\mathbf{b}_1 - \mathbf{b}_0) + u_2(\mathbf{b}_2 - \mathbf{b}_0)$$

$$\mathbf{p} = (1 - u_1 - u_2)\mathbf{b}_0 + u_1\mathbf{b}_1 + u_2\mathbf{b}_2$$

$$\mathbf{p} = \mathbf{B} \begin{bmatrix} 1 - u_1 - u_2 \\ u_1 \\ u_2 \end{bmatrix} = \mathbf{B} \begin{bmatrix} 1 & -1 & -1 \\ 0 & 1 & 0 \\ 0 & 0 & 1 \end{bmatrix} \begin{bmatrix} 1 \\ u_1 \\ u_2 \end{bmatrix} = \mathbf{B} \mathbf{U} \mathbf{u}.$$

\mathbf{u} contains the two inhomogeneous affine coordinates u_1, u_2 of the image point, but shows the quality of a homogeneous vector. Vectors of this kind will be called “quasihomogeneous”.

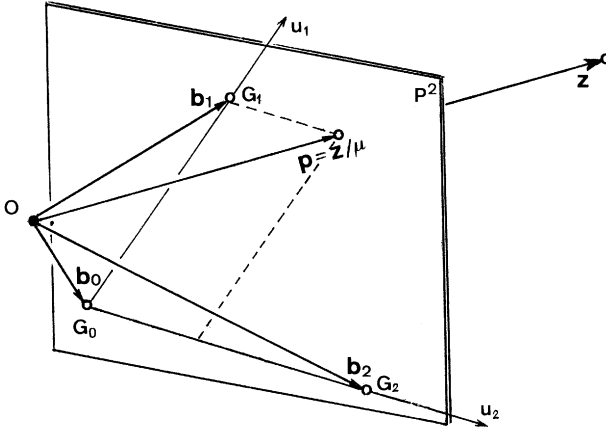
 Fig. 1.1/2. Projection of a point by intersection of \mathbf{z} with P^2

The relations between \mathbf{z} and \mathbf{u} arise from

$$\mathbf{z} = \mu \mathbf{p} = \mu \mathbf{B} \mathbf{U} \mathbf{u} = \mu \mathbf{P} \mathbf{u}, \quad (1.1.4)$$

$$\mathbf{P} = \mathbf{B} \mathbf{U} = [\mathbf{b}_0 (\mathbf{b}_1 - \mathbf{b}_0) (\mathbf{b}_2 - \mathbf{b}_0)].$$

yielding the equation of *reconstruction*, and from

$$\mu \mathbf{u} = \mathbf{U}^* \mathbf{B}^* \mathbf{z} = \mathbf{P}^* \mathbf{z} = \mathbf{P}^* (\mathbf{y} - \mathbf{y}_0) \quad (1.1.5)$$

yielding the equation of *projection* wherein

$$\mathbf{U}^* = \begin{bmatrix} 1 & 1 & 1 \\ 0 & 1 & 0 \\ 0 & 0 & 1 \end{bmatrix} \quad \text{and} \quad \mathbf{P}^* = \mathbf{U}^* \mathbf{B}^* = \begin{bmatrix} \sum b_0^i & \sum b_1^i & \sum b_2^i \\ b_0^1 & b_1^1 & b_2^1 \\ b_0^2 & b_1^2 & b_2^2 \end{bmatrix}.$$

\mathbf{P}^* is the matrix of projection and its structure shows the connexion with the components of the base vectors. Equation (1.1.5) may also be written as

$$\mu \begin{bmatrix} 1 \\ u_1 \\ u_2 \\ 0 \end{bmatrix} = \begin{bmatrix} -\mathbf{P}^* \mathbf{y}_0 & \mathbf{P}^* \\ 0 & \mathbf{0}^\Gamma \end{bmatrix} \begin{bmatrix} 1 \\ y_1 \\ y_2 \\ y_3 \end{bmatrix} \quad \text{or} \quad \mu \mathbf{u} = \mathbf{M}^* \mathbf{y} \quad (1.1.6)$$

\mathbf{y} now being a quasihomogeneous vector. \mathbf{M}^* is a four-dimensional *singular* projective matrix, from which it follows that because of

$$\mathbf{M}^* \mathbf{y}_0 = \mathbf{0}, \quad (1.1.7)$$

the center of projection may be calculated from a known matrix \mathbf{M}^* by solving the simple system (1.1.7).

1.2. Determination of \mathbf{P}^*

In general, four points $G_j (j=0, 1, 2, 3)$ of the object space V^3 can be identified in order to establish an affine coordinate system of the model in V^3 (Fig. 1.2/1). In this case, they are the unit points of the system and hence have the inhomogeneous coordinates

$$\mathbf{e}_0^T = [0 \ 0 \ 0], \quad \mathbf{e}_1^T = [1 \ 0 \ 0], \quad \mathbf{e}_2^T = [0 \ 1 \ 0], \quad \mathbf{e}_3^T = [0 \ 0 \ 1].$$

If these points are projected to P^2 , the images $G'_j (j=0, 1, 2)$ will define the affine system of the image plane as shown in Fig. (1.1/2), where they have the quasihomogeneous coordinates

$$\mathbf{e}'_0{}^T = [1 \ 1 \ 0], \quad \mathbf{e}'_1{}^T = [1 \ 1 \ 0], \quad \mathbf{e}'_2{}^T = [1 \ 0 \ 1].$$

The fourth basic point G_3 is projected into a general image point with quasihomogeneous coordinates

$$\mathbf{e}'_3{}^T = [1 \ u_{31} \ u_{32}].$$

Using this knowledge, the structure of \mathbf{P}^* can be derived from the relations

$$\mu_j \mathbf{e}'_j = \mathbf{P}^* (\mathbf{e}_j - \mathbf{y}_0) \quad (1.2.1)$$

or in scalar terms without comments:

$j=0$:

$$\mu_0 \begin{bmatrix} 1 \\ 0 \\ 0 \end{bmatrix} = \begin{bmatrix} p_0^0 & p_1^0 & p_2^0 \\ p_0^1 & p_1^1 & p_2^1 \\ p_0^2 & p_1^2 & p_2^2 \end{bmatrix} \begin{bmatrix} -y_{01} \\ -y_{02} \\ -y_{03} \end{bmatrix} \Rightarrow \begin{cases} p_0^0 y_{01} + p_1^0 y_{02} + p_2^0 y_{03} = -\mu_0 \\ p_0^1 y_{01} + p_1^1 y_{02} + p_2^1 y_{03} = 0 \\ p_0^2 y_{01} + p_1^2 y_{02} + p_2^2 y_{03} = 0 \end{cases}$$

$j=1$:

$$\mu_1 \begin{bmatrix} 1 \\ 1 \\ 0 \end{bmatrix} = \begin{bmatrix} p_0^0 & p_1^0 & p_2^0 \\ p_0^1 & p_1^1 & p_2^1 \\ p_0^2 & p_1^2 & p_2^2 \end{bmatrix} \begin{bmatrix} 1 - y_{01} \\ -y_{02} \\ -y_{03} \end{bmatrix} = \begin{bmatrix} p_0^0 + \mu_0 \\ p_0^1 \\ p_0^2 \end{bmatrix} \Rightarrow \begin{cases} p_0^0 = \mu_1 - \mu_0 \\ p_0^1 = \mu_1 \\ p_0^2 = 0 \end{cases}$$

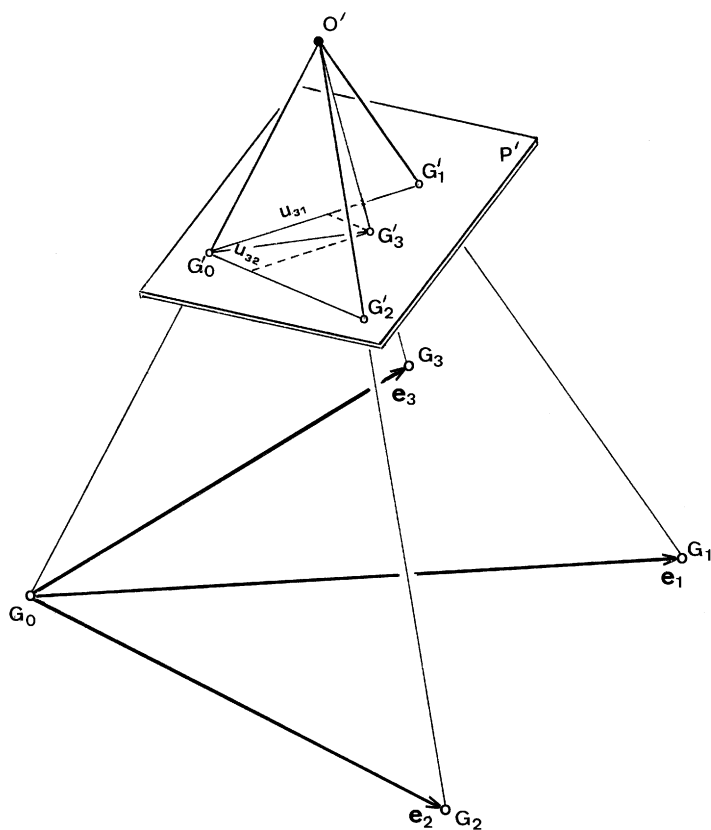
 Fig. 1.2/1. The affine system of V^3 and the corresponding system in P^2

$j = 2$:

$$\mu_2 \begin{bmatrix} 1 \\ 0 \\ 1 \end{bmatrix} = \begin{bmatrix} p_0^0 & p_1^0 & p_2^0 \\ p_0^1 & p_1^1 & p_2^1 \\ p_0^2 & p_1^2 & p_2^2 \end{bmatrix} \begin{bmatrix} -y_{01} \\ 1 - y_{02} \\ -y_{03} \end{bmatrix} = \begin{bmatrix} p_1^0 + \mu_0 \\ p_1^1 \\ p_1^2 \end{bmatrix} \Rightarrow \begin{cases} p_1^0 = \mu_2 - \mu_0 \\ p_1^1 = \mu_2 \\ p_1^2 = 0 \end{cases}$$

$j = 3$:

$$\mu_3 \begin{bmatrix} 1 \\ u_{31} \\ u_{32} \end{bmatrix} = \begin{bmatrix} p_0^0 & p_1^0 & p_2^0 \\ p_0^1 & p_1^1 & p_2^1 \\ p_0^2 & p_1^2 & p_2^2 \end{bmatrix} \begin{bmatrix} -y_{01} \\ -y_{02} \\ 1 - y_{03} \end{bmatrix} = \begin{bmatrix} p_2^0 + \mu_0 \\ p_2^1 \\ p_2^2 \end{bmatrix} \Rightarrow \begin{cases} p_2^0 = \mu_3 - \mu_0 \\ p_2^1 = \mu_3 u_{31} \\ p_2^2 = \mu_3 u_{32} \end{cases}$$

The projective matrix \mathbf{P}^* therefore reads

$$\mathbf{P}^* = \begin{bmatrix} \mu_1 - \mu_0 & \mu_2 - \mu_0 & \mu_3 - \mu_0 \\ \mu_1 & 0 & u_{31}\mu_3 \\ 0 & \mu_2 & u_{32}\mu_3 \end{bmatrix} \quad (1.2.2)$$

and the matrix \mathbf{M}^* of (1.1.6) regarding the results of $j = 0$, is written

$$\mathbf{M}^* = \begin{bmatrix} \mu_0 & \mu_1 - \mu_0 & \mu_2 - \mu_0 & \mu_3 - \mu_0 \\ 0 & \mu_1 & 0 & u_{31}\mu_3 \\ 0 & 0 & \mu_2 & u_{32}\mu_3 \\ 0 & 0 & 0 & 0 \end{bmatrix}. \quad (1.2.3)$$

Strictly speaking, this matrix represents the *core* of every singular projective transformation because of its reference to the affine coordinate systems defined by the basic points. Hence, general projective matrices will contain components which depend on the affine relations between arbitrary coordinate systems and the system of the basic points. The comparatively simple structure of \mathbf{M}^* will enable a method of *linear* relative orientation of projective bundles [2].

1.3. Properties of \mathbf{P}^*

From (1.1.5) or (1.1.6) it follows that division by one component of \mathbf{P}^* merely influences the factor μ , which, moreover, cancels out if the affine coordinates u_i are calculated by means of (1.1.6), that is

$$u_i = \frac{y_i\mu_i + y_3u_{3i}\mu_3}{y_0\mu_0 + y_1\mu_1 + y_2\mu_2 + y_3\mu_3}, \quad i = 1, 2, \quad (1.3.1)$$

introducing $y_0 = 1 - y_1 - y_2 - y_3$ and dividing by the first component. By equating $p_{00} = \mu_0 = 1$, (1.2.2) can hence be written – without changing the notation –

$$\mathbf{P}^* = \begin{bmatrix} \mu_1 - 1 & \mu_2 - 1 & \mu_3 - 1 \\ \mu_1 & 0 & \mu_{31}\mu_3 \\ 0 & \mu_2 & u_{32}\mu_3 \end{bmatrix}, \quad (1.3.2)$$

and \mathbf{M}^* can be defined analogously. If \mathbf{P}^* is regular because of

$$\det(\mathbf{P}^*) = \Delta = \mu_1\mu_2(\mu_3 - 1) - u_{31}(\mu_1 - 1)\mu_2\mu_3 - u_{32}\mu_1(\mu_2 - 1)\mu_3 \neq 0 \quad (1.3.3)$$

the inverse form \mathbf{P} (reconstruction) can also be specified by means of

$\mathbf{P}\mathbf{P}^* = \mathbf{E}$ (unit matrix) with the solution

$$\mathbf{P} = \frac{1}{\Delta} \begin{bmatrix} -\mu_2\mu_3u_{31} & \mu_2(\mu_3-1) - (\mu_2-1)\mu_3u_{32} & (\mu_2-1)\mu_3u_{31} \\ -\mu_1\mu_3u_{32} & (\mu_1-1)\mu_3u_{32} & \mu_1(\mu_3-1) - (\mu_1-1)\mu_3u_{31} \\ \mu_1\mu_2 & -(\mu_1-1)\mu_2 & -\mu_1(\mu_2-1) \end{bmatrix}$$

Insertion of the components of (1.3.2) into the linear equations of the case $j=0$ of (1.2.1) yields the modified system

$$\begin{aligned} (\mu_1-1)y_{01} + (\mu_2-1)y_{02} + (\mu_3-1)y_{03} &= -1 \\ -\mu_1y_{01} & & -u_{31}\mu_3y_{03} &= 0 \\ & -\mu_2y_{02} & -u_{32}\mu_3y_{03} &= 0 \end{aligned} \quad (1.3.4)$$

from which the components of \mathbf{y}_0 result: The second and third equation directly yield the relations

$$y_{01} = -u_{31} \frac{\mu_3}{\mu_1} y_{03}, \quad y_{02} = -u_{32} \frac{\mu_3}{\mu_2} y_{03},$$

and insertion of these terms into the first equation turns it to

$$y_{03} \left\{ -u_{31}(\mu_1-1) \frac{\mu_3}{\mu_1} - u_{32}(\mu_2-1) \frac{\mu_3}{\mu_2} + (\mu_2-1) \right\} = \frac{y_{03}}{\mu_1\mu_2} \Delta = -1 \Rightarrow$$

$$y_{03} = -\frac{\mu_1\mu_2}{\Delta}.$$

Using this expression, the other components take the final form

$$y_{02} = u_{32} \frac{\mu_3\mu_1}{\Delta}, \quad y_{01} = u_{31} \frac{\mu_2\mu_3}{\Delta}.$$

These results also may be obtained from (1.1.7) introducing (1.2.3) and regarding $\mu_0 = 1$.

It is seen that \mathbf{y}_0 is determined by means of the known projective matrix \mathbf{P}^* . However, the opposite possibility, that is solving the system (1.3.4) with respect to μ_1, μ_2, μ_3 , exists as well: equating $u_{30} = 1 - u_{31} - u_{32}$ and analogously

$$y_{00} = 1 - y_{01} - y_{02} - y_{03} = u_{30} \frac{\mu_1\mu_2\mu_3}{\Delta},$$

firstly from the sum of the equations results

$$\left. \begin{aligned} \mu_3 &= -\frac{y_{00}}{u_{30}y_{03}} \\ \mu_2 &= \frac{u_{32}y_{00}}{u_{30}y_{02}}, \quad \mu_1 = \frac{u_{31}y_{00}}{u_{30}y_{01}} \end{aligned} \right\} \quad (1.3.5)$$

and subsequently

Insertion of these coefficients into (1.3.2) yields the form

$$\mathbf{P}^* = \frac{\mathcal{J}_{00}}{u_{30}} \begin{bmatrix} \frac{u_{31} - u_{30}}{\mathcal{J}_{01}} & \frac{u_{32} - u_{30}}{\mathcal{J}_{02}} & \frac{-1}{\mathcal{J}_{03}} & \frac{u_{30}}{\mathcal{J}_{00}} \\ \frac{u_{31}}{\mathcal{J}_{01}} & 0 & -\frac{u_{31}}{\mathcal{J}_{03}} & \\ 0 & \frac{u_{32}}{\mathcal{J}_{02}} & -\frac{u_{32}}{\mathcal{J}_{03}} & \end{bmatrix} \quad (1.3.6)$$

of the matrix of projection which depends exclusively on \mathbf{y}_0 and \mathbf{u}_3 ! In this case, the inverse form (matrix of reconstruction) reads

$$\mathbf{P} = \begin{bmatrix} -\mathcal{J}_{01} & \frac{\mathcal{J}_{01}}{u_{31}\mathcal{J}_{00}} \{ \mathcal{J}_{00}(1 - u_{32}) + u_{30}(\mathcal{J}_{02} + \mathcal{J}_{03}) \} & \frac{\mathcal{J}_{01}}{u_{32}\mathcal{J}_{00}} (u_{32}\mathcal{J}_{00} - u_{30}\mathcal{J}_{02}) \\ -\mathcal{J}_{02} & \frac{\mathcal{J}_{02}}{u_{31}\mathcal{J}_{00}} (u_{31}\mathcal{J}_{00} - u_{30}\mathcal{J}_{01}) & \frac{\mathcal{J}_{02}}{u_{32}\mathcal{J}_{00}} \{ \mathcal{J}_{00}(1 - u_{31}) + u_{30}(\mathcal{J}_{01} + \mathcal{J}_{03}) \} \\ -\mathcal{J}_{03} & \frac{\mathcal{J}_{03}}{u_{31}\mathcal{J}_{00}} (u_{31}\mathcal{J}_{00} - u_{30}\mathcal{J}_{01}) & \frac{\mathcal{J}_{03}}{u_{32}\mathcal{J}_{00}} (u_{32}\mathcal{J}_{00} - u_{30}\mathcal{J}_{02}) \end{bmatrix} \quad (1.3.7)$$

Hence, the choice of a suitable affine coordinate system in the model space, the identification of its unit points as basic points in the image and the knowledge of the coordinates of the center of projection determine completely the projective matrix \mathbf{P}^* and, with exception of a common scale factor, because of $\mathbf{B} = (\mathbf{U}\mathbf{P}^*)^{-1}$ from (1.1.5) also the base

$$\mathbf{B} = (\mathbf{B}^*)^{-1} = (\mathbf{U}\mathbf{P}^*)^{-1} = \mathbf{P}\mathbf{U}^*$$

All these relations depend on the regularity of \mathbf{P}^* . Therefore the validity of $\Delta \neq 0$ is to be proved. In order to clearly understand the geometry, the μ_j in (1.3.3) are substituted by the components of \mathbf{y}_0 as given by the relations (1.3.5). This yields the expression

$$\Delta = \frac{-u_{31}u_{32}\mathcal{J}_{00}^2}{u_{30}^2\mathcal{J}_{01}\mathcal{J}_{02}\mathcal{J}_{03}} \quad (1.3.8)$$

which shows two restrictions:

- a) \mathbf{e}'_3 is not allowed to be collinear with \mathbf{e}'_1 and \mathbf{e}'_2 , respectively, \mathbf{e}_3 is not allowed to be coplanar with the planes G_0-O-G_1 and G_0-O-G_2 in V^3 because of the simultaneous conditions $u_{31} \neq 0$ and $u_{32} \neq 0$.

b) In order to ensure $y_{00} \neq 0$, the center of projection is not allowed to be situated on the plane $E \Rightarrow y_1 + y_2 + y_3 = 1$ passing through the basic points G_1, G_2, G_3 .

(1.3.2) only represents the structure of \mathbf{P}^* , whereas the parameters μ_j are still unknown. The determination of their numerical values from additional informations will be the subject of the subsequent considerations.

1.4. Connection with Orthonormalized Systems

Fig. 1.1/1b shows that in orthonormalized systems the base vectors take the internal form $\mathbf{b}_j^T = (1, x_j - x_C, y_j - y_C)$, containing the unknown coordinates x_C, y_C of the principal point, and the orthogonal matrix of orientation of the image reads $\mathbf{R} = [\mathbf{k}, \mathbf{i}, \mathbf{j}]$. In order to get a simple connexion to the affine systems used here, the symbols and the arrangements do not fully agree with the known standards of notation of analytical photogrammetry, but the dissimilarities are modest and easy to understand. The base vectors related to the external (orthogonal) coordinate system X_1, X_2, X_3 result by these two elements from $\mathbf{b}_j = \mathbf{R}\mathbf{b}'_j$. Insertion of this expression into equation (1.1.3) yields

$$\begin{aligned} \mathbf{p} &= \mathbf{R} \{ (1 - u_1 - u_2) \mathbf{b}'_0 + u_1 \mathbf{b}'_1 + u_2 \mathbf{b}'_2 \} = \mathbf{R} [\mathbf{b}'_0 \mathbf{b}'_1 \mathbf{b}'_2] \begin{bmatrix} 1 - u_1 - u_2 \\ u_1 \\ u_2 \end{bmatrix} \\ &= \mathbf{R} \begin{bmatrix} 1 & 1 & 1 \\ x_0 - x_C & x_1 - x_C & x_2 - x_C \\ y_0 - y_C & y_1 - y_C & y_2 - y_C \end{bmatrix} \begin{bmatrix} 1 & -1 & -1 \\ 0 & 1 & 0 \\ 0 & 0 & 1 \end{bmatrix} \begin{bmatrix} 1 \\ u_1 \\ u_2 \end{bmatrix} \\ &= \mathbf{R} \begin{bmatrix} 1 & 0 & 0 \\ x_0 - x_C & x_1 - x_C & x_2 - x_C \\ y_0 - y_C & y_1 - y_C & y_2 - y_C \end{bmatrix} \begin{bmatrix} 1 \\ u_1 \\ u_2 \end{bmatrix} = \mathbf{R}\mathbf{A}_v \mathbf{u}. \end{aligned} \quad (1.4.1)$$

\mathbf{A}_v is the matrix of the bidimensional homogeneous transformation $\mathbf{v} = \mathbf{A}_v \mathbf{u}$ from affine to rectangular coordinates $\mathbf{v}^T = (1, x, y)$ in the plane \mathbf{P}^2 . \mathbf{p} on the left side depends on the inhomogeneous model coordinates by

$$\lambda \mathbf{p} = (\mathbf{X} - \mathbf{X}_0)$$

as known from analytic photogrammetry. Thus we obtain

$$\lambda^2 = \frac{(\mathbf{X} - \mathbf{X}_0)^T (\mathbf{X} - \mathbf{X}_0)}{\mathbf{p}^T \mathbf{p}} = \frac{(\mathbf{X} - \mathbf{X}_0)^T (\mathbf{X} - \mathbf{X}_0)}{\mathbf{u}^T \mathbf{A}_v^T \mathbf{A}_v \mathbf{u}}, \quad (1.4.2)$$

which is the ratio of the distances from the center of projection to a point of the model and its image point.

Quasihomogeneous affine coordinates \mathbf{y} related to the spatial basic points will be obtained from given quasihomogeneous coordinates $\mathbf{X}^T = (1, X_1, X_2, X_3)$ of a cartesian object space V^3 by the affine transformation

$$\mathbf{y} = \mathbf{A}_X^{-1} \mathbf{X}. \quad (1.4.3)$$

Its inverse matrix \mathbf{A}_X reads, similarly to \mathbf{A}_v ,

$$\mathbf{A}_X = \begin{bmatrix} 1 & 0 & 0 & 0 \\ X_0 & X_1 - X_0 & X_2 - X_0 & X_3 - X_0 \\ Y_0 & Y_1 - Y_0 & Y_2 - Y_0 & Y_3 - Y_0 \\ Z_0 & Z_1 - Z_0 & Z_2 - Z_0 & Z_3 - Z_0 \end{bmatrix}$$

and the components result from the transformations

$$\mathbf{X}_{G_i} = \mathbf{A}_X \mathbf{e}_i \quad (1.4.4)$$

of the homogeneous affine unit vectors \mathbf{e}_i of V^3 into the system of cartesian coordinates \mathbf{X}_{G_i} of the basic points. Therefore, the projective relation between the orthonormalized coordinate systems is given by

$$\mu \mathbf{v} = \mathbf{A}_v \mathbf{M} \mathbf{A}_X^{-1} \mathbf{X}, \quad (1.4.5)$$

wherein \mathbf{M} is the singular projective matrix (1.2.3) which refers to the basic points. Thus, if the coordinates of V^3 or of P^2 do not refer to this system, affine transformations must be applied, so that projective relations between general coordinates consist of a projective transformation of type (1.2.3) and affine transformations in V^3 and P^2 . Moreover, the image coordinates do not have to be orthonormalized and centered but can also have affine values $\mathbf{v}^T = (1, v_1, v_2)$ from any measuring device, e.g. comparator, digitizer, electronic transmitter system (analytical plotter) or display cursor. Nevertheless, equation (1.4.5) will be satisfied without calibration of rectangularity and scales.

From (1.4.3) it follows that

$$\mathbf{X} - \mathbf{X}_0 = \mathbf{A}_X (\mathbf{y} - \mathbf{y}_0) = \mathbf{A}_X \mathbf{z}$$

and by means of this relation we obtain the final expression for λ with

$$\lambda^2 = \frac{\mathbf{z}^T \mathbf{A}_X^T \mathbf{A}_X \mathbf{z}}{\mathbf{u}^T \mathbf{A}_v^T \mathbf{A}_v \mathbf{u}}.$$

By means of (1.4.1) the matrix of projection in equation (1.1.5) turns to

$$\mathbf{P}^* = \mathbf{A}_p^{-1} \mathbf{R}^T \tag{1.4.6}$$

showing its composition of an inhomogeneous orthogonal spatial rotation and a homogeneous plane affine transformation. This equation makes it possible to formulate the normal case of projective images ($\mathbf{R} = \mathbf{E}$) as a pure affine transformation in analogy to the similarity transformation of the normal case of analytical photogrammetry.

1.5. Projection from Space to Space (Regular Projective Transformation)

If \mathbf{M}^* in (1.1.6) is regular, which means that at least one component of the last row must be $\neq 0$, it defines the projective transformation between two tridimensional spaces $V^3 \rightarrow P^3$ (Fig. 1.5) and reads generally

$$\mu \mathbf{u} = \mathbf{M}^* \mathbf{y} = \begin{bmatrix} m_{00} & m_{01} & m_{02} & m_{03} \\ m_{10} & m_{11} & m_{12} & m_{13} \\ m_{20} & m_{21} & m_{22} & m_{23} \\ m_{30} & m_{31} & m_{32} & m_{33} \end{bmatrix} \begin{bmatrix} 1 \\ y_1 \\ y_2 \\ y_3 \end{bmatrix} = \begin{bmatrix} \mathbf{m}_0^T \mathbf{y} \\ \mathbf{m}_1^T \mathbf{y} \\ \mathbf{m}_2^T \mathbf{y} \\ \mathbf{m}_3^T \mathbf{y} \end{bmatrix} \tag{1.5.1}$$

[9]. The basic points of the two systems have corresponding quasihomogeneous coordinates, that is

$$\mathbf{e}_0^T = (1, 0, 0, 0), \quad \mathbf{e}_1^T = (1, 1, 0, 0), \quad \mathbf{e}_2^T = (1, 0, 1, 0), \quad \mathbf{e}_3^T = (1, 0, 0, 1),$$

Applying the same method as in subsection 1.2 by means of the vector equations

$$\mu_j \mathbf{e}'_j = \mathbf{M}^* \mathbf{e}_j, \quad j = 0, 1, 2, 3$$

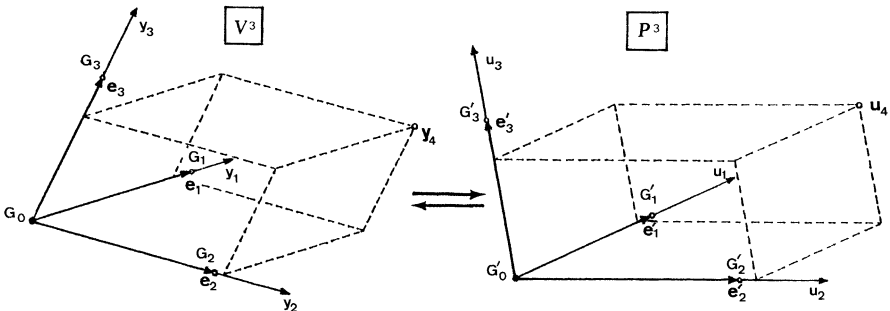

Fig. 1.5. Regular projective transformation $V^3 \leftrightarrow P^3$

the structure of \mathbf{M}^* results in

$$\mathbf{M}^* = \begin{bmatrix} \mu_0 & \mu_1 - \mu_0 & \mu_2 - \mu_0 & \mu_3 - \mu_0 \\ 0 & \mu_1 & 0 & 0 \\ 0 & 0 & \mu_2 & 0 \\ 0 & 0 & 0 & \mu_3 \end{bmatrix}. \quad (1.5.2)$$

representing the *core of a regular projective transformation* (cf. p. 6). A fifth control point enables the calculation of the parameters μ_i from

$$\mu_4 \mathbf{u}_4 = \mathbf{M}^* \mathbf{y}_4 \quad (1.5.3)$$

or in scalar expressions

$$\left. \begin{aligned} \mu_0 &= \mu_4 \frac{1 - u_1 - u_2 - u_3}{1 - y_1 - y_2 - y_3} = \mu_4 \frac{u_0}{y_0} \\ \mu_1 &= \mu_4 \frac{u_1}{y_1}; \quad \mu_2 = \mu_4 \frac{u_2}{y_2}; \quad \mu_3 = \mu_4 \frac{u_3}{y_3} \end{aligned} \right\} \quad (1.5.4)$$

wherein μ_4 may have any value, because the inhomogeneous components of \mathbf{u} in equation (1.5.1) follow from

$$u_i = \frac{\mathbf{m}_i^T \mathbf{y}}{\mathbf{m}_0^T \mathbf{y}} = \frac{\mu_i y_i}{\mu_0 + (\mu_1 - \mu_0) y_1 + (\mu_2 - \mu_0) y_2 + (\mu_3 - \mu_0) y_3}, \quad i = 1, 2, 3, \quad (1.5.5)$$

and μ_4 cancels out. As a general fact it is seen that the determination of the parameters of regular projective transformations related to a vector space V^n needs $n + 2$ control points.

There will be two important applications of these tridimensional projective transformations:

- a) Reconstruction of a spatial model in affine or cartesian coordinates from a projectively distorted model after relative orientation of projective bundles,
- b) Spatial optical projection of digital stereo pairs by means of an optical projector, similar to the rectification of photograms of plane objects [4]

The first application is directly based on the use of Eq. (1.5.2), the second one results from the fact that ideal optical projection can be represented by projective matrices. (1.5.1) defines the projective transformation of points. But also linear entities (in V^3 planes in V^2 lines) will be transformed projectively. Generally, their homogeneous equation may be

written in V^n as $\mathbf{a}^T \mathbf{y} = 0$, which is to be transformed to a linear entity

$$\mathbf{a}'^T \mathbf{u} = \mathbf{a}'^T \mathbf{M}^* \mathbf{y} = 0$$

($1/\mu$ cancels out) in P^n . Thus we obtain the relations

$$\mathbf{a}'^T = \mathbf{a}'^T \mathbf{M}^* \quad \text{or} \quad \mathbf{a} = \mathbf{M}^{*T} \mathbf{a}' \quad (1.5.6)$$

and, if \mathbf{M} represents the inverse of \mathbf{M}^* ,

$$\mathbf{a}' = \mathbf{M}^T \mathbf{a} \quad (1.5.7)$$

for the transformation of the coefficients \mathbf{a} of V^n to coefficients \mathbf{a}' of P^n . An identic procedure transforms the coefficients \mathbf{A} of conics $\mathbf{y}^T \mathbf{A} \mathbf{y} = 0$ from V^n to $\mathbf{A}' = \mathbf{M}^T \mathbf{A} \mathbf{M}$ in P^n , but entities of second degree will not be used here.

1.6. Optical Projection

The optical projection from an object space V^3 to an image space P^3 or vice versa may be defined by means of the projective matrices

$$\mathbf{M}_f = f \begin{bmatrix} 1 & 0 & 0 & 1/f \\ 0 & 1 & 0 & 0 \\ 0 & 0 & 1 & 0 \\ 0 & 0 & 0 & 1 \end{bmatrix}, \quad \mathbf{M}_f^{-1} = \frac{1}{f} \begin{bmatrix} 1 & 0 & 0 & -1/f \\ 0 & 1 & 0 & 0 \\ 0 & 0 & 1 & 0 \\ 0 & 0 & 0 & 1 \end{bmatrix}.$$

They refer to the orthogonal coordinate system of the optical axis of the projecting device and yield the transformations ($i = 1, 2, 3$)

$$V^3 \Rightarrow P^3 \quad \tau \mathbf{z}' = \mathbf{M}_f \mathbf{z} \quad (1.6.1)$$

$$\xi'_i = \frac{f \xi_i}{f + \xi_3} \Rightarrow i = 3: \quad \frac{1}{\xi'_3} - \frac{1}{\xi_3} = \frac{1}{f}$$

$$P^3 \Rightarrow V^3 \quad \mathbf{z} = \tau \mathbf{M}_f^{-1} \mathbf{z}' \quad (1.6.2)$$

$$\xi_i = \frac{f \xi'_i}{f - \xi'_3} \Rightarrow i = 3: \quad \frac{1}{\xi_3} - \frac{1}{\xi'_3} = -\frac{1}{f}$$

which, by the way, in scalar notation agree with the well-known classical equation of geometric optics created by C. F. Gauss. The image scale of the projection results from

$$m' = \frac{\xi'_i}{\xi_i} = \frac{f}{f + \xi_3} = \frac{f - \xi'_3}{f} \Rightarrow \frac{1}{\xi'_3} - \frac{1}{\xi_3} = \frac{1}{f}$$

and again yields the Gauss equation. Elements in the infinity of V^3 ($\xi_i = \infty$ or $f - \xi'_3 = 0$) produce finite images in the plane $\xi'_3 = f$ (= focal plane of P^3) and all linear entities which project to the infinity of P^3 ($\xi'_i = 0$ or $f + \xi_3 = 0$) must be elements of the plane $\xi_3 = -f$ (= focal plane of V^3). In general, optical systems are composed of several lenses and are hence represented by two principal planes H and H' . But as the distance between them does not appear in the projective equations, it may be neglected and the optical system may be represented by one principal plane H only. With respect to the following considerations, this plane is the $[\xi_1, \xi_2]$ -plane, and the optical axis orthogonal to it contains the ξ_3 -direction of the (cartesian) coordinate system in use (Fig. 1.6/1).

The projection of an image plane

$$E \Rightarrow \mathbf{a}^T \mathbf{z} = a_0 + a_1 \xi_1 + a_2 \xi_2 + a_3 \xi_3 = 0$$

in V^3 by means of (1.6.1) will again produce a plane E' in P^3 represented by the relation

$$E' \Rightarrow \mathbf{a}'^T \mathbf{z}' = 0$$

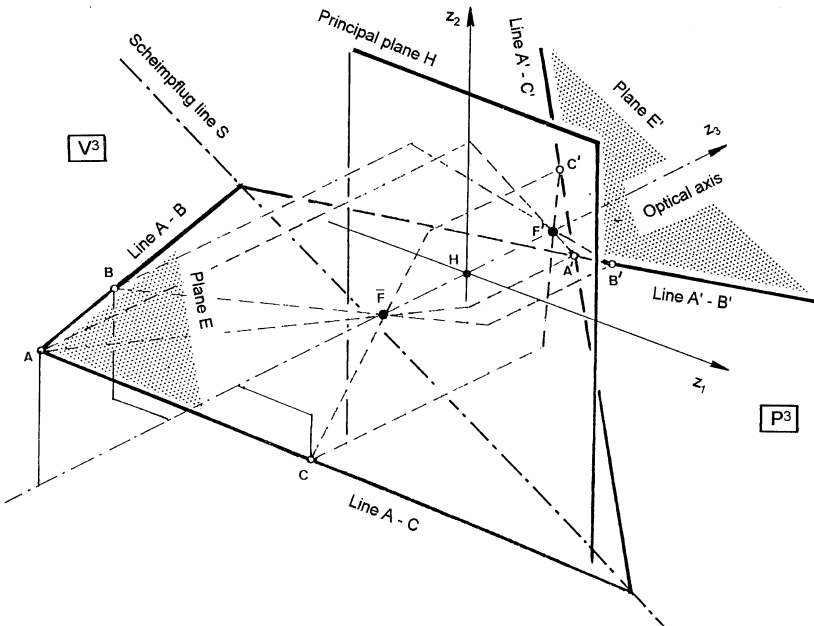

Fig. 1.6/1. Optical projection and Scheimpflug condition

where the coefficients \mathbf{a}' of E' read because of (1.5.7),

$$\mathbf{a}'^T = \mathbf{a}^T \mathbf{M}_f^{-1} = [a_0/f \quad a_1/f \quad a_2/f \quad (-a_0/f + a_3)/f].$$

By means of these coefficients the scalar equation of the plane E' reads

$$E' \Rightarrow f a_0 + f a_1 z'_1 + f a_2 z'_2 + (f a_3 - a_0) z'_3 = 0.$$

It is easily seen that at the positions $z_3 = z'_3 = 0$ E and E' convert to the identic line equations

$$S \Rightarrow a_0 + a_1 z_1 + a_2 z_2 = 0$$

$$S' \Rightarrow f a_0 + f a_1 z'_1 + f a_2 z'_2 = 0$$

of intersection with the principal plane H of the optical system (Fig. 1.6/1). This line $S \equiv S'$ is the geometric representation of the Scheimpflug condition concerning the optical projection of planes: E and E' must intersect simultaneously with H in S . This condition was introduced to optical rectification by Th. Scheimpflug but was generally formulated much earlier by *E. Abbe*. Every optical projection of images should satisfy this condition in order to achieve sharp focus over the whole screen area.

The intersection of E with the focal plane $z_3 = -f$ yields a line

$$V \Rightarrow (a_0 - f a_3) + a_1 z_1 + a_2 z_2 = 0 \dots\dots\dots \text{vanishing line in } E \quad (1.6.3)$$

and the intersection of E' with the focal plane $z'_3 = f$ a line

$$V' \Rightarrow f a_3 + a_1 z'_1 + a_2 z'_2 = 0 \dots\dots\dots \text{vanishing line in } E' \text{ or "horizon"}. \quad (1.6.4)$$

These two straight lines represent the images of the remote linear entities in E and E' , they are parallel to S and S' (Fig. 1.6/2), respectively, and are important elements with respect to the orientation of the images to be projected to a screen.

If the affine coordinate systems in E and E' are defined by means of the non-collinear basic points G_i and G'_i , the relation between the contents of these planes is given by the regular projective matrices

$$\mathbf{M}^* = \begin{bmatrix} \mu_0 & \mu_1 - \mu_0 & \mu_2 - \mu_0 \\ 0 & \mu_1 & 0 \\ 0 & 0 & \mu_2 \end{bmatrix} \text{ and } \mathbf{M} = \begin{bmatrix} 1/\mu_0 & 1/\mu_1 - 1/\mu_0 & 1/\mu_2 - 1/\mu_0 \\ 0 & 1/\mu_1 & 0 \\ 0 & 0 & 1/\mu_2 \end{bmatrix}$$

and the transformations are

$$\mu \mathbf{u}' = \mathbf{M}^* \mathbf{u} \quad \text{or} \quad \mathbf{u} = \mu \mathbf{M} \mathbf{u}'. \quad (1.6.5)$$

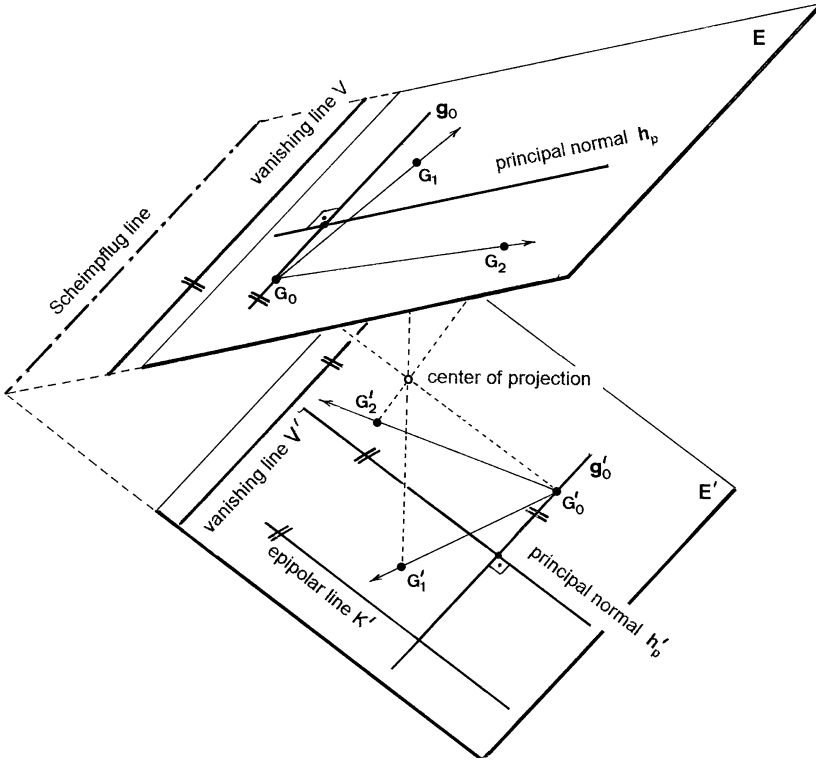

Fig. 1.6/2. Optical projection $V^3 \rightarrow P^3$ (rectification)

By equating to zero the first components of these two transformations we obtain the images of linear entities at infinity. They read

$$\text{in } E: \mu_0 + (\mu_1 - \mu_0)u_1 + (\mu_2 - \mu_0)u_2 = \mathbf{g}^T \mathbf{u} = 0,$$

$$\text{in } E': 1/\mu_0 + (1/\mu_1 - 1/\mu_0)u'_1 + (1/\mu_2 - 1/\mu_0)u'_2 = \mathbf{g}'^T \mathbf{u}' = 0.$$

and must coincide with V of (1.6.3) and V' of (1.6.4), respectively. Thus, if the Scheimpflug condition is satisfied and this coincidence is achieved, the projection of only one additional control point ensures the correctness of the rectifying procedure. The lines S , S' and V , V' in screen projections should be horizontal for an optimum stereo representation.

Very often the vanishing lines V of the images do not lie inside the image fields. In such cases parallel lines to V may be used. The most practicable parallels are those passing the origins G_0 of the affine

coordinate systems (Fig. 1.6/2). They read simply

$$\begin{aligned} \text{in } E: (\mu_1 - \mu_0)u_1 + (\mu_2 - \mu_0)u_2 &= \mathbf{g}_0^T \mathbf{u} = 0, \\ \text{in } E': (1/\mu_1 - 1/\mu_0)u'_1 + (1/\mu_2 - 1/\mu_0)u'_2 &= \mathbf{g}'_0{}^T \mathbf{u}' = 0. \end{aligned} \quad (1.6.6)$$

and correspond projectively because of

$$\mathbf{g}'_0 = \mathbf{M}^T \mathbf{g}_0.$$

In E and E' there also exist the so-called “principal normals” \mathbf{h}_p and \mathbf{h}'_p (Fig. 1.6/2) which include right angles with the vanishing lines and the Scheimpflug line. Because of

$$\mathbf{h}'_p = \mathbf{M}^T \mathbf{h}_p,$$

they are also corresponding projective entities and, together with \mathbf{g}_0 and \mathbf{g}'_0 , establish a kind of natural rectangular system of axes. If necessary, this system may be used for rectangular representation of image contents after projection. Moreover, in analogous projecting systems, such as rectifiers or screen projectors, \mathbf{h}_p and \mathbf{h}'_p must coincide with the lines of maximum inclination of E and E' passing through the optical axis. The “image displacement” in traditional rectifiers must occur along these lines until the vanishing lines coincide.

2. Image Correlation and Relative Orientation

2.1. Spatial Intersection and the Matrix of Correlation

The reconstruction of a spatial object from relatively oriented images P' and P'' is based on the spatial intersection

$$\mu' \mathbf{p}' = \mathbf{d} + \mu'' \mathbf{p}'' \quad (2.1.1)$$

of the inhomogeneous vectors \mathbf{p}' , \mathbf{p}'' from the two ends of a base $\mathbf{d} = \mathbf{y}'_0 - \mathbf{y}''_0$ (Fig. 2.1). Knowing that in affine systems scalar and cross products of vectors can also be applied, (2.1.1) yields, after vector multiplication by \mathbf{d} and scalar multiplication by \mathbf{p}'' , because of

$$(\mathbf{p}'' \times \mathbf{d}) \cdot \mathbf{p}'' = 0$$

the well-known condition of coplanarity

$$(\mathbf{p}' \times \mathbf{d}) \cdot \mathbf{p}'' = 0 \quad (2.1.2)$$

The left part of this relation can also be written as

$$\mathbf{p}' \times \mathbf{d} = \mathbf{p}'^T \mathbf{D} = [p'_1 p'_2 p'_3] \begin{bmatrix} 0 & -d_3 & d_2 \\ d_3 & 0 & -d_1 \\ -d_2 & d_1 & 0 \end{bmatrix}$$

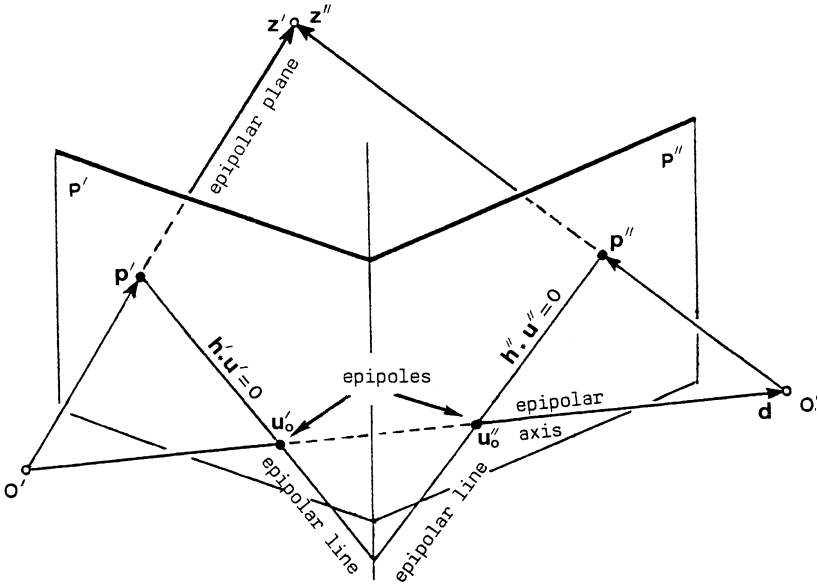

Fig. 2.1. Spatial intersection and epipolar entities

and according to (1.1.4) $\mathbf{p} = \mathbf{P} \mathbf{u}$ holds, so that (2.1.2) converts to

$$\mathbf{p}'^T \mathbf{D} \mathbf{p}'' = \mathbf{u}'^T \mathbf{P}'^T \mathbf{D} \mathbf{P}'' \mathbf{u}'' = \mathbf{u}'^T \mathbf{C} \mathbf{u}'' = 0. \quad (2.1.3)$$

\mathbf{C} is the matrix of image correlation [16], which contains the elements of relative orientation [15]. By means of the column vectors \mathbf{p}_j ($j = 0, 1, 2$) of \mathbf{P} the more detailed structure

$$\begin{aligned} \mathbf{C} &= \begin{bmatrix} \mathbf{p}'_0 \\ \mathbf{p}'_1 \\ \mathbf{p}'_2 \end{bmatrix}^T \begin{bmatrix} 0 & -d_3 & d_2 \\ d_3 & 0 & -d_1 \\ -d_2 & d_1 & 0 \end{bmatrix} \begin{bmatrix} \mathbf{p}''_0 \\ \mathbf{p}''_1 \\ \mathbf{p}''_2 \end{bmatrix} \\ &= \begin{bmatrix} (\mathbf{p}'_0 \times \mathbf{d}) \cdot \mathbf{p}''_0 & (\mathbf{p}'_0 \times \mathbf{d}) \cdot \mathbf{p}''_1 & (\mathbf{p}'_0 \times \mathbf{d}) \cdot \mathbf{p}''_2 \\ (\mathbf{p}'_1 \times \mathbf{d}) \cdot \mathbf{p}''_0 & (\mathbf{p}'_1 \times \mathbf{d}) \cdot \mathbf{p}''_1 & (\mathbf{p}'_1 \times \mathbf{d}) \cdot \mathbf{p}''_2 \\ (\mathbf{p}'_2 \times \mathbf{d}) \cdot \mathbf{p}''_0 & (\mathbf{p}'_2 \times \mathbf{d}) \cdot \mathbf{p}''_1 & (\mathbf{p}'_2 \times \mathbf{d}) \cdot \mathbf{p}''_2 \end{bmatrix} \end{aligned} \quad (2.1.4)$$

results. The special qualities of \mathbf{C} are:

1. $\det(\mathbf{C}) = 0$ because of $\det(\mathbf{D}) = 0$.
2. If

$$\mathbf{u}'^T \mathbf{C} = \mathbf{h}''^T \quad \text{and} \quad \mathbf{C} \mathbf{u}'' = \mathbf{h}', \quad (2.1.5)$$

the correlation matrix establishes the dual transformations [10]
 $\mathbf{u}' \rightarrow \mathbf{h}''$ and $\mathbf{u}'' \rightarrow \mathbf{h}'$ yielding lines

$$\mathbf{h}'^T \mathbf{u}' = 0 \quad \text{or} \quad \mathbf{h}''^T \mathbf{u}'' = 0$$

in the corresponding image.

3. The epipoles \mathbf{u}_0 arise from the projection $\mu_0 \mathbf{u}_0 = \mathbf{P}^* \mathbf{d}$ and the dual transformations of the \mathbf{u}_0 read because of $\mathbf{P}^* \mathbf{P} = \mathbf{E}$ and $\mathbf{D} \mathbf{d} = \mathbf{0}$

$$\mathbf{C} \mathbf{u}_0'' = \mathbf{P}'^T \mathbf{D} \mathbf{P}'' \mathbf{P}''^* \mathbf{d} = \mathbf{0},$$

$$\mathbf{u}_0'^T \mathbf{C} = \mathbf{d} \mathbf{P}^* \mathbf{P}'^T \mathbf{D} \mathbf{P}'' = \mathbf{0}.$$

Hence the coordinates of the epipoles can be calculated by means of the known matrix \mathbf{C} analogously to (1.1.7) from

$$\mathbf{C}^T \mathbf{u}' = \mathbf{0} \quad \text{and} \quad \mathbf{C} \mathbf{u}_0'' = \mathbf{0}. \quad (2.1.6)$$

[16]. The solutions are consistent because of $\text{rank}(\mathbf{C}) = 2$.

4. The dualistic transformation $\mathbf{P}' \rightarrow \mathbf{P}''$ produces the line $\mathbf{h}''^T \mathbf{u}'' = 0$. The substitution of \mathbf{u}'' by \mathbf{u}_0'' yields

$$\mathbf{h}''^T \mathbf{u}_0'' = \mathbf{u}'^T \mathbf{C} \mathbf{u}_0'' = \mathbf{u}'^T \mathbf{0} \equiv 0$$

and shows the important fact, that the coordinates of the epipole satisfy identically every straight line \mathbf{h}'' or, in other words, every linear entity $\mathbf{h}''^T \mathbf{u}'' = 0$ contains the epipole \mathbf{u}_0'' and represents an epipolar line. Thus, the known correlation matrix enables the direct determination of the geometric loci of homologous points.

5. By means of (1.1.4) equation (2.1.1) turns to

$$\mu' \mathbf{P}' \mathbf{u}' = \mathbf{d} + \mu'' \mathbf{P}'' \mathbf{u}''$$

and after multiplication from the left by \mathbf{D} to

$$\mu' \mathbf{D} \mathbf{P}' \mathbf{u}' = \mu'' \mathbf{D} \mathbf{P}'' \mathbf{u}'' \quad (2.1.7)$$

This symmetric relation between the image coordinates may be multiplied from the left successively by \mathbf{P}'^T and \mathbf{P}''^T . The resulting equations

$$\mu' \mathbf{P}'^T \mathbf{D} \mathbf{P}' \mathbf{u}' = \mu'' \mathbf{P}''^T \mathbf{D} \mathbf{P}'' \mathbf{u}'' = \mu'' \mathbf{C} \mathbf{u}'' = \mu'' \mathbf{h}',$$

$$\mu'' \mathbf{P}''^T \mathbf{D} \mathbf{P}'' \mathbf{u}'' = \mu' \mathbf{P}'^T \mathbf{D} \mathbf{P}' \mathbf{u}' = -\mu' \mathbf{C}^T \mathbf{u}' = -\mu' \mathbf{h}'' \quad (2.1.8)$$

(“-” because of $\mathbf{D}^T = -\mathbf{D}$) contain all elements of the projective transformations $\mathbb{V}^3 \rightarrow \mathbf{P}'$ and $\mathbb{V}^3 \rightarrow \mathbf{P}''$ but are unfortunately very nonlinear. It will be a task of the following considerations to

develop less complicated relations between the elements of orientation and the matrix of correlation.

The matrix products on the left of (2.1.8) as well as \mathbf{C} must be singular of rank two. In the following they will be called $\mathbf{P}^T \mathbf{D} \mathbf{P} = \mathbf{K}$. Again introducing, analogously to (2.1.4), the column vectors \mathbf{p}_j of \mathbf{P} , furthermore $D = \det(\mathbf{P})$ and the row vectors \mathbf{p}^i of \mathbf{P}^* , the detailed structure

$$\begin{aligned}
 \mathbf{K} &= \begin{bmatrix} \mathbf{p}_0^T \\ \mathbf{p}_1^T \\ \mathbf{p}_2^T \end{bmatrix} \begin{bmatrix} 0 & -d_3 & d_2 \\ d_3 & 0 & -d_1 \\ -d_2 & d_1 & 0 \end{bmatrix} [\mathbf{p}_0 \mathbf{p}_1 \mathbf{p}_2] \\
 &= \begin{bmatrix} 0 & (\mathbf{p}_0 \times \mathbf{d}) \cdot \mathbf{p}_1 & (\mathbf{p}_0 \times \mathbf{d}) \cdot \mathbf{p}_2 \\ (\mathbf{p}_1 \times \mathbf{d}) \cdot \mathbf{p}_0 & 0 & (\mathbf{p}_1 \times \mathbf{d}) \cdot \mathbf{p}_2 \\ (\mathbf{p}_2 \times \mathbf{d}) \cdot \mathbf{p}_0 & (\mathbf{p}_2 \times \mathbf{d}) \cdot \mathbf{p}_1 & 0 \end{bmatrix} \\
 &= \begin{bmatrix} 0 & -(\mathbf{p}_0 \times \mathbf{p}_1) \cdot \mathbf{d} & (\mathbf{p}_2 \times \mathbf{p}_0) \cdot \mathbf{d} \\ (\mathbf{p}_0 \times \mathbf{p}_1) \cdot \mathbf{d} & 0 & -(\mathbf{p}_1 \times \mathbf{p}_2) \cdot \mathbf{d} \\ -(\mathbf{p}_2 \times \mathbf{p}_0) \cdot \mathbf{d} & (\mathbf{p}_1 \times \mathbf{p}_2) \cdot \mathbf{d} & 0 \end{bmatrix} \\
 &= \frac{1}{D} \begin{bmatrix} 0 & -\mathbf{p}^2 \cdot \mathbf{d} & \mathbf{p}^1 \cdot \mathbf{d} \\ \mathbf{p}^2 \cdot \mathbf{d} & 0 & -\mathbf{p}^0 \cdot \mathbf{d} \\ -\mathbf{p}^1 \cdot \mathbf{d} & \mathbf{p}^0 \cdot \mathbf{d} & 0 \end{bmatrix} = \begin{bmatrix} 0 & -\kappa_2 & \kappa_1 \\ \kappa_2 & 0 & -\kappa_0 \\ -\kappa_1 & \kappa_0 & 0 \end{bmatrix} \quad (2.1.9)
 \end{aligned}$$

is obtained in skewsymmetric form. It enables the introduction of the dual relations

$$\mathbf{K}' \mathbf{u}' = (\mu''/\mu') \mathbf{h}' \quad \text{or} \quad \mathbf{K}'' \mathbf{u}'' = -(\mu'/\mu'') \mathbf{h}'' \quad (2.1.10)$$

between point $\mathbf{u}^{(\theta)}$ and its epipolar line $\mathbf{h}^{(\theta)}$ and additionally, because of

$$\mathbf{K}^{(\theta)} \mathbf{u}_0^{(\theta)} = \mathbf{0} \quad (2.1.11)$$

the computation of the coordinates of the epipole in $\mathbf{P}^{(\theta)}$ itself from

$$\mathbf{u}_0^{(\theta)} = \frac{1}{\kappa_0^{(\theta)}} \begin{bmatrix} \kappa_0^{(\theta)} \\ \kappa_1^{(\theta)} \\ \kappa_2^{(\theta)} \end{bmatrix}. \quad (2.1.12)$$

Moreover there exist, referring to the basic points $G_j^{(i)}$ (section 1.2), because of (2.1.8) the simple relations

$$\begin{aligned}\mu_j' \mathbf{K}' \mathbf{e}_j' &= \mu_j'' \mathbf{C} \mathbf{e}_j'' \\ \mu_j'' \mathbf{K}'' \mathbf{e}_j'' &= -\mu_j' \mathbf{C}^T \mathbf{e}_j',\end{aligned}\quad (2.1.13)$$

between the components of $\mathbf{K}^{(i)}$ and \mathbf{C} , if the parameters $\mu_j^{(i)}$ of orientation are known.

2.2. Determination and Utilization of the Correlation Matrix

$\mathbf{C} \{c_{jk}\}$ ($j/k = 0, 1, 2$) consists of nine unknown components. With regard to its homogeneity, \mathbf{C} can be divided by one component, that is $\xi_{jk} = c_{jk}/c_{10}$, or more in detail

$$\frac{1}{c_{10}} \begin{bmatrix} c_{00} & c_{01} & c_{02} \\ c_{10} & c_{11} & c_{12} \\ c_{20} & c_{21} & c_{22} \end{bmatrix} = \begin{bmatrix} \xi_{00} & \xi_{01} & \xi_{02} \\ 1 & \xi_{11} & \xi_{12} \\ \xi_{20} & \xi_{21} & \xi_{22} \end{bmatrix} \Rightarrow \mathbf{C} = c_{10} \mathbf{Z}, \quad (2.2.1)$$

so that eight unknowns are left to be determined. The dividing component is not allowed to vanish and, for practical computations, it should be the numerically largest one. Supposing quasi-homogeneous affine coordinates \mathbf{u} and the approximate normal case, c_{01} or c_{10} satisfy this requirement [2], but in general it is not possible to predict definitely the most stable component; thus it must be chosen by trial [8].

The procedure based on (2.1.3) using (2.2.1) requires measured coordinates of eight homologous points of P' and P'' in opposition to relative orientation of conventional photogrammetry, where only five homologous points are needed. The coordinates of every pair of such points must satisfy the equation

$$[1 \ u_1' \ u_2']_i \begin{bmatrix} \xi_{00} & \xi_{01} & \xi_{02} \\ 1 & \xi_{11} & \xi_{12} \\ \xi_{20} & \xi_{21} & \xi_{22} \end{bmatrix} \begin{bmatrix} 1 \\ u_1'' \\ u_2'' \end{bmatrix} = 0 \quad i = 0 \dots 7$$

and thus one row of the resulting 8×8 -system $\mathbf{A}_8 \mathbf{z} = \mathbf{a}$ reads (without index i)

$$\begin{aligned}\xi_{00} + u_1'' \xi_{01} + u_2'' \xi_{02} + u_1' u_1'' \xi_{11} + u_1' u_2'' \xi_{12} + u_2' \xi_{20} + u_2' u_1'' \xi_{21} \\ + u_2' u_2'' \xi_{22} = -u_1'\end{aligned}$$

with the solution $\mathbf{z} = \mathbf{A}_8^{-1} \mathbf{a}$. Consequently, \mathbf{Z} consists of the calculated ξ_{jk} and $\xi_{10} = 1$, but due to its homogeneity it can be used directly instead of \mathbf{C} in the calculation of the epipoles \mathbf{u}_0 according to (2.1.6) and of the epipolar lines \mathbf{h} according to (2.1.5). Considering three of the homolo-

Table 2.2. Coefficients of the 8×8 -system \mathbf{A}_8 in affine coordinates referred to the system of the basic points

Row	\tilde{z}_{00}	\tilde{z}_{01}	\tilde{z}_{02}	\tilde{z}_{11}	\tilde{z}_{12}	\tilde{z}_{20}	\tilde{z}_{21}	\tilde{z}_{22}	\mathbf{a}
0	1	0	0	0	0	0	0	0	0
1	1	1	0	1	0	0	0	0	-1
2	1	0	1	0	0	1	0	1	0
3									
	1	u''_1	u''_2	$u'_1 u''_1$	$u'_1 u''_2$	u'_2	$u'_2 u''_1$	$u'_2 u''_2$	$-u'_1$
7									

gous points as basic points G_j , the affine coordinates may be referred again to the axes across them. In this way the first three rows of \mathbf{A}_8 contain very simple coefficients (Table 2.2) and yield the relations

$$\tilde{z}_{00} = 0, \quad \tilde{z}_{01} = -1 - \tilde{z}_{11}, \quad \tilde{z}_{02} = -\tilde{z}_{20} - \tilde{z}_{22}, \quad (2.2.2)$$

whereby three unknowns may be eliminated which indicate only relations between the affine systems. The remaining five equations prove the wellknown fact, that the intersection of five corresponding rays of the two bundles of projection satisfies the relative orientation of the images P' and P'' .

Again, if image coordinates \mathbf{v}_i are measured in a more general affine system, the special coordinates \mathbf{u}_i arise according to (1.3.5) from $\mathbf{u}_i = \mathbf{A}\mathbf{v}_i$ and the correlation related to the \mathbf{v}_i reads, analogously to (1.3.6)

$$\mathbf{v}^T \mathbf{A}'^T \mathbf{C} \mathbf{A}'' \mathbf{v}'' = \mathbf{v}^T \bar{\mathbf{C}} \mathbf{v}'' = 0.$$

If the \mathbf{v}_i are centered cartesian image coordinates, $\bar{\mathbf{C}}$ will agree with the projective correlation matrix [14] or [16].

The use of affine coordinates referred to the basic points reduces the number of components of \mathbf{Z} because of (2.2.2) to five significant parameters. Therefore the matrix now reads

$$\mathbf{Z} = \begin{bmatrix} 0 & -1 - \tilde{z}_{11} & -\tilde{z}_{20} - \tilde{z}_{22} \\ 1 & \tilde{z}_{11} & \tilde{z}_{12} \\ \tilde{z}_{20} & \tilde{z}_{21} & \tilde{z}_{22} \end{bmatrix} \quad (2.2.3)$$

and instead of an 8×8 -system only a 5×5 -system consisting of the equations

$$\begin{aligned} u_1''(u_1' - 1) \zeta_{11} + u_1' u_2'' \zeta_{12} + (u_2' - u_2'') \zeta_{20} + u_2' u_1'' \zeta_{21} \\ + u_2''(u_2' - 1) \zeta_{22} = u_1'' - u_1' \end{aligned} \quad (2.2.4)$$

must be solved. By means of its solutions the coefficients \mathbf{h} of the epipolar lines result in

$$\begin{aligned} \mathbf{h}' &= \begin{bmatrix} 0 & -1 - \zeta_{11} & -\zeta_{20} - \zeta_{22} \\ 1 & \zeta_{11} & \zeta_{12} \\ \zeta_{20} & \zeta_{21} & \zeta_{22} \end{bmatrix} \begin{bmatrix} 1 \\ u_1'' \\ u_2'' \end{bmatrix} \\ &= \begin{bmatrix} -(1 + \zeta_{11})u_1'' & -(\zeta_{20} + \zeta_{22})u_2'' \\ 1 + \zeta_{11}u_1'' & +\zeta_{12}u_2'' \\ \zeta_{20} + \zeta_{21}u_1'' & +\zeta_{22}u_2'' \end{bmatrix} \end{aligned} \quad (2.2.5)$$

$$\begin{aligned} \mathbf{h}'' &= \begin{bmatrix} 0 & 1 & \zeta_{20} \\ -1 - \zeta_{11} & \zeta_{11} & \zeta_{21} \\ -\zeta_{20} - \zeta_{22} & \zeta_{12} & \zeta_{22} \end{bmatrix} \begin{bmatrix} 1 \\ u_1' \\ u_2' \end{bmatrix} \\ &= \begin{bmatrix} u_1' + \zeta_{20}u_2' \\ -1 - \zeta_{11} + \zeta_{11}u_1' + \zeta_{21}u_2' \\ -\zeta_{20} - \zeta_{22} + \zeta_{12}u_1' + \zeta_{22}u_2' \end{bmatrix} \end{aligned}$$

and the coordinates of the epipoles result from linear equations, which correspond with the components of \mathbf{h}'' (for \mathbf{u}_0') and \mathbf{h}' (for \mathbf{u}_0''). Selecting the equations of identic determinants

$$D = \zeta_{11} \zeta_{22} - \zeta_{12} \zeta_{21}$$

(second and third component of $\mathbf{h}^{(i)}$), the coordinates are in P'

$$\begin{aligned} u_{01}' &= \{-\zeta_{22}(1 + \zeta_{11}) + \zeta_{21}(\zeta_{20} + \zeta_{22})\}/D \\ u_{02}' &= \{-\zeta_{11}(\zeta_{20} + \zeta_{22}) + \zeta_{12}(1 + \zeta_{11})\}/D \end{aligned} \quad (2.2.6)$$

and in P''

$$\begin{aligned} u_{01}'' &= (\zeta_{22} - \zeta_{12} \zeta_{20})/D \\ u_{02}'' &= (\zeta_{11} \zeta_{20} - \zeta_{21})/D \end{aligned} \quad (2.2.7)$$

Another possibility for the determination of the epipolar lines may be derived from (2.1.10), that is in the image $P^{(i)}$ itself. Since their coefficients \mathbf{h} cannot be influenced by any common constant, the quotients of the $\mu^{(i)}$

may be omitted and the scalar notation becomes

$$\begin{bmatrix} 0 & -\kappa_2 & \kappa_1 \\ \kappa_2 & 0 & -\kappa_0 \\ -\kappa_1 & \kappa_0 & 0 \end{bmatrix} \begin{bmatrix} 1 \\ u_1 \\ u_2 \end{bmatrix} = \begin{bmatrix} 0 & u_2 & -u_1 \\ -u_2 & 0 & 1 \\ u_1 & -1 & 0 \end{bmatrix} \begin{bmatrix} \kappa_0 \\ \kappa_1 \\ \kappa_2 \end{bmatrix} = \begin{bmatrix} b_0 \\ b_1 \\ b_2 \end{bmatrix} \quad (2.2.8)$$

yielding \mathbf{h} if $\mathbf{k}^T = (\kappa_0, \kappa_1, \kappa_2)$ is known. From (2.1.11) it is seen, that \mathbf{k} depends on the epipole \mathbf{u}_0 by the relation

$$\begin{bmatrix} 0 & u_{02} & -u_{01} \\ -u_{02} & 0 & 1 \\ u_{01} & -1 & 0 \end{bmatrix} \begin{bmatrix} \kappa_0 \\ \kappa_1 \\ \kappa_2 \end{bmatrix} = \mathbf{0}.$$

This again results in (2.1.12), but in the sense of determining the κ_j from the coordinates of the epipole with the exception of a common constant. As the \mathbf{u}_0 result from \mathbf{C}^T or \mathbf{C} , respectively, (2.2.8) converts to the equation

$$\begin{aligned} \begin{bmatrix} b_0 \\ b_1 \\ b_2 \end{bmatrix} &= \begin{bmatrix} 0 & u_2 & -u_1 \\ -u_2 & 0 & 1 \\ u_1 & 1 & 0 \end{bmatrix} \begin{bmatrix} 1 \\ u_{01} \\ u_{02} \end{bmatrix} = \begin{bmatrix} 0 & -u_{02} & -u_{01} \\ u_{02} & 0 & -1 \\ -u_{01} & 1 & 0 \end{bmatrix} \begin{bmatrix} 1 \\ u_1 \\ u_2 \end{bmatrix} \\ &= \begin{bmatrix} u_2 u_{01} - u_1 u_{02} \\ -u_2 + u_{02} \\ u_1 - u_{01} \end{bmatrix} \end{aligned} \quad (2.2.9)$$

which corresponds with the determination of the components of \mathbf{h} from the two given points \mathbf{u}_0 (epipole) and \mathbf{u} (any other point in the image). The epipolar entities and their relations to the components of the correlation matrix will be significant elements of all subsequent considerations on algebro-projective photogrammetric problems.

2.3. Critical Situations of Projective Image Correlation

The solution of the system $\mathbf{a} = \mathbf{A}_8 \mathbf{z}$ depends on the regularity of \mathbf{A}_8 , that is $\det(\mathbf{A}_8) \neq 0$. The components of this matrix are composed of image coordinates which are connected with the object space $V(\mathbf{y})$ by

$$u_i = \frac{y_j \mu_i + y_3 u_{3i} \mu_3}{1 + \sum (\mu_j - 1) y_{ji}} = \frac{\mathbf{m}_i^T \mathbf{y}}{\mathbf{m}_0^T \mathbf{y}} = \frac{n_i}{d}, \quad (i = 1, 2, j = 1, 2, 3) \quad (2.3.1)$$

corresponding to (1.3.1). Expressing them by these relations the determinant of \mathbf{A}_8 reads

$$\det(\mathbf{A}_8) = \begin{vmatrix} 1 & 0 & 0 & 0 & 0 & 0 & 0 & 0 \\ 1 & 1 & 0 & 1 & 0 & 0 & 0 & 0 \\ 1 & 0 & 1 & 0 & 0 & 1 & 0 & 1 \\ \vdots & \vdots & \vdots & \vdots & \vdots & \vdots & \vdots & \vdots \\ 1 & \frac{n''_{1k}}{d''_{1k}} & \frac{n''_{2k}}{d''_{2k}} & \frac{n'_{1k}n''_{1k}}{d'_{1k}d''_{1k}} & \frac{n'_{1k}n''_{2k}}{d'_{1k}d''_{2k}} & \frac{n'_{2k}}{d'_{2k}} & \frac{n'_{2k}n''_{1k}}{d'_{2k}d''_{1k}} & \frac{n'_{2k}n''_{2k}}{d'_{2k}d''_{2k}} \\ \vdots & \vdots & \vdots & \vdots & \vdots & \vdots & \vdots & \vdots \end{vmatrix} \quad (2.3.2)$$

with $k = 3 \dots \dots 7$ (index of spatial correlation points). The indices $k = 0, 1, 2$ belong to the basic points G_k (Fig. 1.2/1).

From (2.3.2) can be recognized that $\det(\mathbf{A}_8)$ corresponds with the determinant of a matrix \mathbf{A}_7 where the first row and the first column of \mathbf{A}_8 are bordered. Thus the equivalence $\det(\mathbf{A}_8) = \det(\mathbf{A}_7) = 0$ indicates critical distributions of the points of correlation in the object space. $\det(\mathbf{A}_7)$ can be expanded into *two* subdeterminants with respect to the two components = 1 of the second row. The resulting determinants still contain the components of the third row of \mathbf{A}_8 with respect to which a second expansion can be performed yielding six subdeterminants, now exclusively composed by the coordinates of *five* general object points. Symbolizing each partial determinant by only one row k , the complete expansion of \mathbf{A}_8 to a 5×5 – determinant reads

$$\det(\mathbf{A}_7) = \begin{vmatrix} \frac{n'_{1k}n''_{1k}}{d'_{1k}d''_{1k}} & \frac{n'_{1k}n''_{2k}}{d'_{1k}d''_{2k}} & \frac{n'_{2k}}{d'_{2k}} & \frac{n'_{2k}n''_{1k}}{d'_{2k}d''_{1k}} & \frac{n'_{2k}n''_{2k}}{d'_{2k}d''_{2k}} \end{vmatrix} - \begin{vmatrix} \frac{n''_{2k}}{d''_{2k}} & \frac{n'_{1k}n''_{1k}}{d'_{1k}d''_{1k}} & \frac{n'_{1k}n''_{2k}}{d'_{1k}d''_{2k}} & \frac{n'_{2k}n''_{1k}}{d'_{2k}d''_{1k}} & \frac{n'_{2k}n''_{2k}}{d'_{2k}d''_{2k}} \end{vmatrix} \\ - \begin{vmatrix} \frac{n''_{2k}}{d''_{2k}} & \frac{n'_{1k}n''_{1k}}{d'_{1k}d''_{1k}} & \frac{n'_{1k}n''_{2k}}{d'_{1k}d''_{2k}} & \frac{n'_{2k}}{d'_{2k}} & \frac{n'_{2k}n''_{2k}}{d'_{2k}d''_{2k}} \end{vmatrix} - \begin{vmatrix} \frac{n''_{1k}}{d''_{1k}} & \frac{n'_{1k}n''_{2k}}{d'_{1k}d''_{2k}} & \frac{n'_{2k}}{d'_{2k}} & \frac{n'_{2k}n''_{1k}}{d'_{2k}d''_{1k}} & \frac{n'_{2k}n''_{2k}}{d'_{2k}d''_{2k}} \end{vmatrix} \\ - \begin{vmatrix} \frac{n''_{1k}}{d''_{1k}} & \frac{n''_{2k}}{d''_{2k}} & \frac{n'_{1k}n''_{2k}}{d'_{1k}d''_{2k}} & \frac{n'_{2k}n''_{1k}}{d'_{2k}d''_{1k}} & \frac{n'_{2k}n''_{2k}}{d'_{2k}d''_{2k}} \end{vmatrix} - \begin{vmatrix} \frac{n''_{1k}}{d''_{1k}} & \frac{n''_{2k}}{d''_{2k}} & \frac{n'_{1k}n''_{2k}}{d'_{1k}d''_{2k}} & \frac{n'_{2k}}{d'_{2k}} & \frac{n'_{2k}n''_{1k}}{d'_{2k}d''_{1k}} \end{vmatrix}$$

Regarding the detailed relations $d_k = 1 + (\mu_1 - 1)y_{1k} + (\mu_2 - 1)y_{2k} + (\mu_3 - 1)y_{3k}$ and $n_{ik} = y_{ik}\mu_i + y_{3k}\mu_3$ from (2.3.1), it is obvious that in the

case of complete coplanarity ($y_{3k} = 0$) all determinants will vanish simultaneously because of containing proportional columns of the kind $\mu'_1 \mu''_2 y_{1k} y_{2k} / d'_k d''_k$. Therefrom results that at least two of the correlation points have to be situated outside the plane $G_0 - G_1 - G_2$ representing the basic point G_3 in correspondence to the initial definition of the coordinate system in the object space (subsection 1.2, Fig. 1.2/1) and an additional point P_x . Otherwise the projective relations refer to regular projectivities between two-dimensional spaces according to rectification (subsection 1.6).

Another possibility of reducing $\det(\mathbf{A}_7)$ to a 5×5 -determinant $\det(\mathbf{A}_5)$ is to subtract its first column from the third and its second column from the fifth and seventh and expanding two times with respect to the first columns. The result will be

$$\det(\mathbf{A}_5) = \left| \begin{array}{ccc} \frac{\mathbf{y}_k^T \mathbf{m}'_1 (\mathbf{m}'_1 - \mathbf{m}'_0)^T \mathbf{y}_k}{\mathbf{y}_k^T \mathbf{m}'_0 \mathbf{m}'_0} & \frac{\mathbf{y}_k^T \mathbf{m}'_1 \mathbf{m}'_2}{\mathbf{y}_k^T \mathbf{m}'_0 \mathbf{m}'_0} & \frac{\mathbf{y}_k^T (\mathbf{m}'_2 \mathbf{m}'_0 - \mathbf{m}'_2 \mathbf{m}'_0)^T}{\mathbf{y}_k^T \mathbf{m}'_0 \mathbf{m}'_0} \\ \frac{\mathbf{y}_k^T \mathbf{m}'_2 \mathbf{m}'_1}{\mathbf{y}_k^T \mathbf{m}'_0 \mathbf{m}'_0} & \frac{\mathbf{y}_k^T \mathbf{m}'_2 (\mathbf{m}'_2 - \mathbf{m}'_0)^T}{\mathbf{y}_k^T \mathbf{m}'_0 \mathbf{m}'_0} & \vdots \\ \vdots & \vdots & \vdots \end{array} \right|_{k=3}^{k=7}$$

which corresponds with the determinant of a system composed by five equations (2.2.4).

Equating $\det(\mathbf{A}_5) = 0$, the products $\mathbf{y}_k^T \mathbf{m}'_0 \mathbf{m}'_0$ in the denominators cancel out and the remaining components represent quadratic functions of the homogeneous coordinates \mathbf{y}_k . If one point, for example \mathbf{y}_7 , is considered to be a variable point and the determinant is expanded into subdeterminants $D_1 (1 = 1 \dots 5)$ with respect to this row $k = 7$ ([15], pp. 422–427), that is

$$\begin{aligned} & \mathbf{y}^T \mathbf{m}'_1 (\mathbf{m}'_1 - \mathbf{m}'_0)^T \mathbf{y} D_1 - \mathbf{y}^T \mathbf{m}'_1 \mathbf{m}'_2 \mathbf{y} D_2 + \mathbf{y}^T (\mathbf{m}'_2 \mathbf{m}'_0 - \mathbf{m}'_2 \mathbf{m}'_0)^T \mathbf{y} D_3 \\ & - \mathbf{y}^T \mathbf{m}'_2 \mathbf{m}'_1 \mathbf{y} D_4 + \mathbf{y}^T \mathbf{m}'_2 (\mathbf{m}'_2 - \mathbf{m}'_0)^T \mathbf{y} D_5 = 0, \end{aligned} \quad (2.3.3)$$

a quadratic function in the affine object space arises which may be expressed by the usual short homogeneous matrix formula $\mathbf{y}^T \mathbf{Q} \mathbf{y} = 0$, where \mathbf{Q} contains the scalar results of the multiplications concerning \mathbf{m}_i and D_i in (2.3.3). The centers of projection, however, must be points of this surface as well, because, according to (1.1.7), all products of the kind $\mathbf{m}^T \mathbf{y}_0$ equal zero and therefore formula (2.3.3) is satisfied identically with respect to \mathbf{y}'_0 or \mathbf{y}''_0 . Hence it follows that \mathbf{A}_5 becomes singular if the points $\mathbf{k} = 3 \dots 7$ and the centers of projection belong simultaneously to a (singly or doubly) rule *quadric surface* [11, 18], the well-known critical surfaces of relative orientation (cylinder, cone, hyperbolic paraboloid).

Besides of this general critical surface, projective image correlation becomes also singular if one of the columns of $\det(\mathbf{A}_5)$ vanishes. As each

nominator of it represents a quadratic form $\mathbf{y}_k^T \mathbf{Q} \mathbf{y}_k$, it will be identically zero by passing all five points and it is obvious that for every column an individual critical surface exists. Because of $\mathbf{m}^T \mathbf{y}_0 = 0$, all of them must contain also the centers of projection. It will be necessary to discuss separately this manifold of critical situations in a special investigation on singularities of projective image correlation.

Till now, from computational experience it is known in accordance to $\det(\mathbf{A}_7) = 0$ that six points may be coplanar and hence at least two points must be situated outside the plane $G_0-G_1-G_2$. The distribution in the ground-plan must be largely irregular because a regular raster corresponding to the well-known Gruber distribution causes singularities too. Nevertheless, with regard to practical computer algorithms it is necessary to discover critical configurations automatically and to provide strategies to improve the location of correlation points in order to avoid singular situations of image correlation and relative stereo orientation.

2.4. Relative Orientation

Relative orientation is determined, if five homologous rays of the bundles intersect in space. As in equation (1.2.1) four of them are already fixed by definition of the basic points (Fig. 2.3), a fifth ray and a point of intersection connected to it must be preassigned. This fifth ray is represented by the epipolar axis and a spatial point can be assumed everywhere on this entity, because all points of it project into the same image points, the epipoles. Hence relative orientation will be derived here from the results of correlation, especially from the coordinates of the epipoles given by $\mathbf{C}^T \mathbf{u}'_0 = \mathbf{0}$ and $\mathbf{C} \mathbf{u}''_0 = \mathbf{0}$.

The projection of a point \mathbf{y}_A (Fig. 2.3) of the epipolar axis into the images may be obtained by means of the scalar version of equation (1.1.6) using \mathbf{M}^* corresponding to (1.2.3) and equating $\mu_0 = 1$

$$\left. \begin{aligned} \mathcal{Y}_{A0} + \mathcal{Y}_{A1} \mu_1 + \mathcal{Y}_{A2} \mu_2 + \mathcal{Y}_{A3} \mu_3 &= \mu_A \\ \mathcal{Y}_{A1} \mu_1 + \mathcal{Y}_{A2} \mu_2 + u_{31} \mathcal{Y}_{A3} \mu_3 &= \mu_A u_{01} \\ \mathcal{Y}_{A2} \mu_2 + u_{32} \mathcal{Y}_{A3} \mu_3 &= \mu_A u_{02} \end{aligned} \right\} \quad (2.3.0)$$

After elimination of μ_A by dividing the second and the third equation by the first one, the following two equations

$$\left. \begin{aligned} \mathcal{Y}_{A1} (u_{01} - 1) \mu_1 + \mathcal{Y}_{A2} u_{01} + \mathcal{Y}_{A3} (u_{01} - u_{31}) \mu_3 &= -u_{01} \mathcal{Y}_{A0} \\ \mathcal{Y}_{A1} u_{02} \mu_1 + \mathcal{Y}_{A2} (u_{02} - 1) \mu_2 + \mathcal{Y}_{A3} (u_{02} - u_{32}) \mu_3 &= -u_{02} \mathcal{Y}_{A0} \end{aligned} \right\} \quad (2.3.1)$$

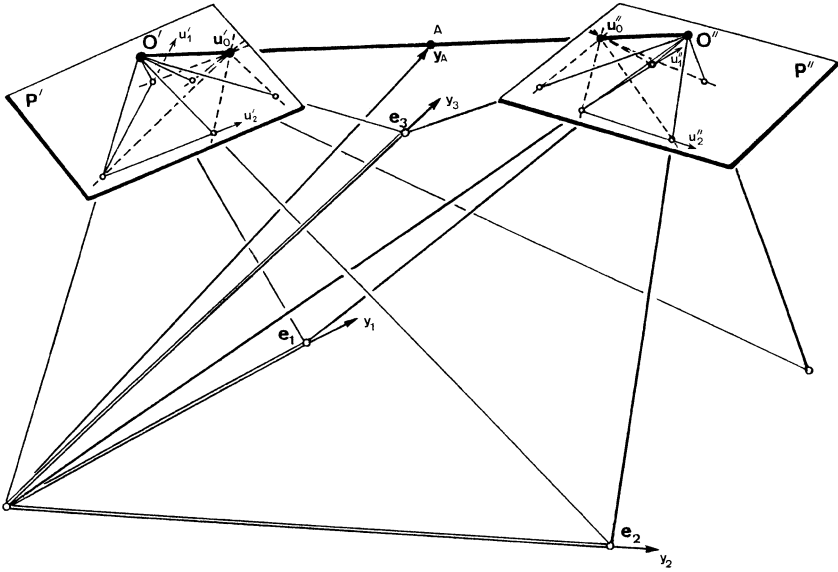

Fig. 2.3. Relative orientation of the two projective bundles P' and P''

are obtained. They contain the three unknowns μ_1, μ_2, μ_3 and the procedure to treat this underdefiniteness will depend on the position of the bundle.

a) Left bundle P'

As five parameters are necessary for relative orientation, the left bundle may be fixed by two parameters. Hence one μ' can be assumed, but in order to get reasonable magnitudes the condition $\mu'_1 = \mu'_2$ is introduced. Thus, the two remaining parameters follow from symmetric equations

$$\begin{aligned} \{y_{A1}(u'_{01} - 1) + y_{A2}u'_{01}\}\mu'_2 + y_{A3}(u'_{01} - u'_{31})\mu'_3 &= -u'_{01}y_{A0} \\ \{y_{A1}u'_{02} + y_{A2}(u'_{02} - 1)\}\mu'_2 + y_{A3}(u'_{02} - u'_{32})\mu'_3 &= -u'_{02}y_{A0} \end{aligned}$$

with the solutions

$$\begin{aligned} \mu'_1 = \mu'_2 &= y_{A0}y_{A3}(u'_{01}u'_{32} - u'_{02}u'_{31})/D' \\ \mu'_3 &= y_{A0}(y_{A1}u'_{02} - y_{A2}u'_{01})/D' \\ D' &= y_{A1}y_{A3}\{u'_{32}(1 - u'_{01}) - u'_{02}(1 - u'_{31})\} \\ &\quad + y_{A2}y_{A3}\{-u'_{31}(1 - u'_{02}) + u'_{01}(1 - u'_{32})\} \end{aligned} \quad (2.3.2)$$

The procedure becomes singular if $D' = 0$ or, in other words, if:

- $\mathcal{Y}_{A3} = 0$, hence \mathbf{y}_A is not allowed to be situated in the plane $[\mathbf{e}_1, \mathbf{e}_2]$;
- $\mathcal{Y}_{A1} = \mathcal{Y}_{A2} = 0$ simultaneously, therefore \mathbf{y}_A must be assumed outside the \mathbf{e}_3 -axis;
- $\mathbf{u}_0 = \mathbf{u}_3$, therefore G_3 is not allowed to be a point of the epipolar axis.

The first restriction is trivial, the second one excludes $\mathbf{y}_A^T = (0, 0, \mathcal{Y}_{A3})$, the third one does not concern the selection of \mathbf{y}_A but the choice of the fourth basic point from the contents of the images, and in general it will not bring about any difficulty. Thus the assumption of \mathbf{y}_A is not very critical and an approximate knowledge about the relative position of the epipolar axis against the object will ensure a suitable choice.

b) Right bundle P''

The coordinates \mathbf{y}'_0 of the left center of projection are functions of the μ'_j (subsection 1.3) and, in connexion with \mathbf{y}_A , define the direction of the base (collinearity of $\mathbf{y}'_0, \mathbf{y}_A, \mathbf{y}''_0$). Thus the epipole in P'' is the projection of two known points, from which two pairs of equations (2.3.1) follow. The second pair contains the coordinates \mathcal{Y}'_{0i} , $i = 0, 1, 2, 3$, instead of the coordinates \mathcal{Y}_{Ai} . By means of their rearranged form they yield

$$\mathcal{Y}_{A1}(\mu''_{01} - 1)\mu''_1 + \mathcal{Y}_{A2}\mu''_{01}\mu''_2 = -\mu''_{01}\mathcal{Y}_{A0} - \mathcal{Y}_{A3}(\mu''_{01} - \mu\mu''_{31})\mu''_3 \quad (2.3.3)$$

$$\mathcal{Y}_{A1}\mu''_{02}\mu''_1 + \mathcal{Y}_{A2}(\mu''_{02} - 1)\mu''_2 = -\mu''_{02}\mathcal{Y}_{A0} - \mathcal{Y}_{A3}(\mu''_{02} - \mu\mu''_{32})\mu''_3$$

and with $D'' = \mathcal{Y}_{A1}\mathcal{Y}_{A2}\mu''_{00}(\mu''_{00} = 1 - \mu''_{01} - \mu''_{02})$ the interdependencies

$$\mu''_1(\mathbf{y}_A) = \frac{1}{\mathcal{Y}_{A1}\mu''_{00}} \{ \mathcal{Y}_{A3}[\mu''_{01}(1 - \mu''_{32}) - \mu''_{31}(1 - \mu''_{02})] \mu''_3 + \mathcal{Y}_{A0}\mu''_{01} \},$$

$$\mu''_2(\mathbf{y}_A) = \frac{1}{\mathcal{Y}_{A2}\mu''_{00}} \{ \mathcal{Y}_{A3}[\mu''_{02}(1 - \mu''_{31}) - \mu''_{32}(1 - \mu''_{01})] \mu''_3 + \mathcal{Y}_{A0}\mu''_{02} \},$$

$$\mu''_1(\mathbf{y}_0) = \frac{1}{\mathcal{Y}_{01}\mu''_{00}} \{ \mathcal{Y}_{03}[\mu''_{01}(1 - \mu''_{32}) - \mu''_{31}(1 - \mu''_{02})] \mu''_3 + \mathcal{Y}_{00}\mu''_{01} \},$$

$$\mu''_2(\mathbf{y}_0) = \frac{1}{\mathcal{Y}_{02}\mu''_{00}} \{ \mathcal{Y}_{03}[\mu''_{02}(1 - \mu''_{31}) - \mu''_{32}(1 - \mu''_{01})] \mu''_3 + \mathcal{Y}_{00}\mu''_{02} \},$$

of μ''_1 and μ''_2 with μ''_3 . Again it is seen that \mathbf{y}_A and \mathbf{y}'_0 must be situated outside the \mathbf{e}_3 -axis, but moreover, the expression $\mu''_{00} = 1 - \mu''_{01} - \mu''_{02}$ is not allowed to vanish. In consequence of and in analogy to the restrictions concerning (1.3.6), \mathbf{u}''_0 must avoid the line $-\mu''_1 - \mu''_2 = -10$ in the image, and \mathbf{y}_A and \mathbf{y}'_0 are not allowed to coincide with the plane $G_1 - O'' - G_2$ in space.

By equating the expressions for μ_1'' and μ_2'', u_{00}'' cancels out and the two equations

$$\begin{aligned} (\mathcal{Y}_{01}\mathcal{Y}_{A3} - \mathcal{Y}_{03}\mathcal{Y}_{A1}) \{u_{01}''(1 - u_{32}'') - u_{31}''(1 - u_{02}'')\} \mu_3'' &= (\mathcal{Y}_{00}\mathcal{Y}_{A1} - \mathcal{Y}_{01}\mathcal{Y}_{A0}) u_{01}'' \\ (\mathcal{Y}_{02}\mathcal{Y}_{A3} - \mathcal{Y}_{03}\mathcal{Y}_{A2}) \{u_{02}''(1 - u_{31}'') - u_{32}''(1 - u_{01}'')\} \mu_3'' &= (\mathcal{Y}_{00}\mathcal{Y}_{A2} - \mathcal{Y}_{02}\mathcal{Y}_{A0}) u_{02}'' \end{aligned}$$

containing μ_3'' arise. The solutions are equivalent because of the equality

$$\begin{aligned} &(\mathcal{Y}_{01}\mathcal{Y}_{A3} - \mathcal{Y}_{03}\mathcal{Y}_{A1})(\mathcal{Y}_{00}\mathcal{Y}_{A2} - \mathcal{Y}_{02}\mathcal{Y}_{A0}) \{u_{01}''(1 - u_{32}'') - u_{31}''(1 - u_{02}'')\} u_{02}'' \\ &= (\mathcal{Y}_{02}\mathcal{Y}_{A3} - \mathcal{Y}_{03}\mathcal{Y}_{A2})(\mathcal{Y}_{00}\mathcal{Y}_{A1} - \mathcal{Y}_{01}\mathcal{Y}_{A0}) \{u_{02}''(1 - u_{31}'') - u_{32}''(1 - u_{01}'')\} u_{01}'' \end{aligned}$$

and yield, by insertion into the explicit solutions of (2.2.3), the components of \mathbf{P}'' or of \mathbf{y}_0'' (= second center of projection) corresponding to the solutions of subsection 1.3.

c) Determination of the “relative” spatial model

By means of the five parameters $\mu_2', \mu_3', \mu_1'', \mu_2'', \mu_3''$, of the relative orientation a “relative” spatial model $M(\bar{\mathbf{y}})$ may be reconstructed in the system of the basic points. In comparison with the original object, this reconstruction must be projectively distorted, because in general the parameters $\mu_j^{(0)}$ will not agree with the parameters of the original projections to P' and P'' . The linear equations to be used for this purpose result from (1.5.5) with

$$(u_i' \mathbf{m}'_0 - \mathbf{m}'_i)^T \bar{\mathbf{y}} = 0 \quad \text{and} \quad (u_i'' \mathbf{m}''_0 - \mathbf{m}''_i)^T \bar{\mathbf{y}} = 0, \quad i = 1, 2, \quad (2.3.4)$$

using \mathbf{M}^* of (1.2.3). These are, in analogy to the spatial intersection of analytical photogrammetry, four equations for the three unknown inhomogeneous components of $\bar{\mathbf{y}}$. The detailed form of the coefficients is given in Table 2.3. The transition to a usual cartesian object space is to be performed by means of a general projective transformation based on five control points. If these control points agree with the basic points, the projective matrix will correspond with (1.5.2). Otherwise the affine-projective arrangement of subsection 1.4 obviously must be used.

3. Transformation to the Normal Case

3.1. Principles

The idea to transform a general stereo pair to the normal case seems to have been created for the first time by W. Kreiling [12] in order to reconstruct digital spatial models from digitized metric photographic stereo pairs. His transformation indirectly results from conventional

Table 2.3. Coefficients of relative reconstruction

row	\bar{y}_1	\bar{y}_2	\bar{y}_3
1	$u'_1(\mu'_1 - 1) - \mu'_1$	$u'_1(\mu'_2 - 1)$	$u'_1(\mu'_3 - 1) - \mu'_{31}\mu'_3$
2	$u'_2(\mu'_1 - 1)$	$u'_2(\mu'_2 - 1) - \mu'_2$	$u'_2(\mu'_3 - 1) - \mu'_{32}\mu'_3$
3	$u''_1(\mu''_1 - 1) - \mu''_1$	$u''_1(\mu''_2 - 1)$	$u''_1(\mu''_3 - 1) - \mu''_{31}\mu''_3$
4	$u''_2(\mu''_1 - 1)$	$u''_2(\mu''_2 - 1) - \mu''_2$	$u''_2(\mu''_3 - 1) - \mu''_{32}\mu''_3$

tridimensional relative orientation in the coordinate system of the base line. For the same purpose Haggren and Niini [8] derived a direct bidimensional transformation from the components of the matrix of correlation, using the condition of equal vertical coordinates of homologous points after transformation. The parameters of this normal case transformation correspond to the parameters of relative orientation, which may be extracted from the components of the matrix of correlation [3].

If only an undisturbed spatial impression of the projected object is required, there is no need for an absolute orientation. Hence the transformations will result from the projective matrices \mathbf{P}' and \mathbf{P}'' of the relative orientation of the projective bundles and from the subsequent projections of every bundle into the image plane of the relative normal case by means of its individual \mathbf{P}_N^* . The formulation of this procedure may be obtained from equation (1.1.4) by applying it for both images, regarding $\mathbf{z} = \mathbf{y} - \mathbf{y}_0$ and substituting it into equation (1.1.5), that is

$$\mathbf{y} = \mathbf{y}'_0 + \mu' \mathbf{P}' \mathbf{u}' = \mathbf{y}''_0 + \mu'' \mathbf{P}'' \mathbf{u}''$$

For one image (without superscripts) thus results

$$\begin{aligned} \mu_N \mathbf{u}_N &= \mathbf{P}_N^* (\mathbf{y} - \mathbf{y}_0) = \mathbf{P}_N^* (\mathbf{y}_0 + \mu \mathbf{P} \mathbf{u} - \mathbf{y}_0) \\ \tau \mathbf{u}_N &= \mathbf{P}_N^* \mathbf{P} \mathbf{u} = \mathbf{T} \mathbf{u}, \quad \tau = \mu_N / \mu. \end{aligned} \quad (3.1.1)$$

\mathbf{T} is composed of the matrix of reconstruction (1.3.7) related to the original projective bundle and of the matrix of projection to the normal case in correspondence with (1.3.6), replacing there \mathbf{u}_3 by \mathbf{u}_{N3} . After laborious but elementary calculations, the multiplication of those two matrices results in the surprisingly uncomplicated structure

$$\mathbf{T} = \begin{bmatrix} 1 & \tau_1 - 1 & \tau_2 - 1 \\ 0 & \tau_1 & 0 \\ 0 & 0 & \tau_2 \end{bmatrix}, \quad \tau_i = \frac{u_{30} u_{N3i}}{u_{N30} u_{3i}}, \quad i = 0, 1, 2, \quad (3.1.2)$$

which represents a pure and regular projective 2D-transformation. \mathbf{u}_{N3} is a corresponding point of the normal case with respect to a known point \mathbf{u}_3 of the original image. The desired transformation therefore depends exclusively on the fourth points \mathbf{u}_3 and \mathbf{u}_{N3} . The inhomogeneous coordinates of the transformed image \mathbf{P}_N result by means of (3.1.2) from the simple projective transformation

$$u_{Ni} = \frac{\tau_i u_i}{1 + (\tau_1 - 1)u_1 + (\tau_2 - 1)u_2}, \quad i = 1, 2 \quad (3.1.3)$$

and correspond to the transformations defined by (1.6.5), regarding $\mu_0 = 1, \mu_1 = \tau_1, \mu_2 = \tau_2$. This result may be explained by the fact that the normal case plane P_N intersects the same bundle as the original image plane P did with respect to the same center of projection, and the relation between the contents of those two planes must therefore be a regular bidimensional projectivity.

3.2. The Normal Case

In systems of cartesian coordinates, the definition of the normal case is a rather elementary task by means of parallel directions of exposure perpendicular to the base [3]. But using affine coordinates related to basic points, the concept of rectangularity becomes meaningless and another definition must be introduced. Thus, instead of rectangularity and equal focal lengths, the more general notions of “coincidence of the image planes” ($P'_N \equiv P''_N \equiv P_N$) and “parallelism of the common plane to the base” must be applied. They are equivalent to the postulation of parallel and identic epipolar lines (epipoles in infinity) in the plane P_N of the new images (Fig. 3.2/1). Therefore the coefficients b_{N1} and b_{N2} of the equations

$$\mathbf{h}_N^T \mathbf{u}_N = b_{N0} + b_{N1}u_{N1} + b_{N2}u_{N2} = 0$$

of the epipolar lines have to be constant and hence mutually independent of the coordinates of the other image. This condition is satisfied because of equation (2.2.5), if and only if the components $\zeta_{11}, \zeta_{12}, \zeta_{21}$ and ζ_{22} become zero. Thus the matrix of correlation takes the simple skewsymmetric form

$$\mathbf{Z}_N = \begin{bmatrix} 0 & -1 & -\zeta_N \\ 1 & 0 & 0 \\ \zeta_N & 0 & 0 \end{bmatrix}, \quad (3.2.1)$$

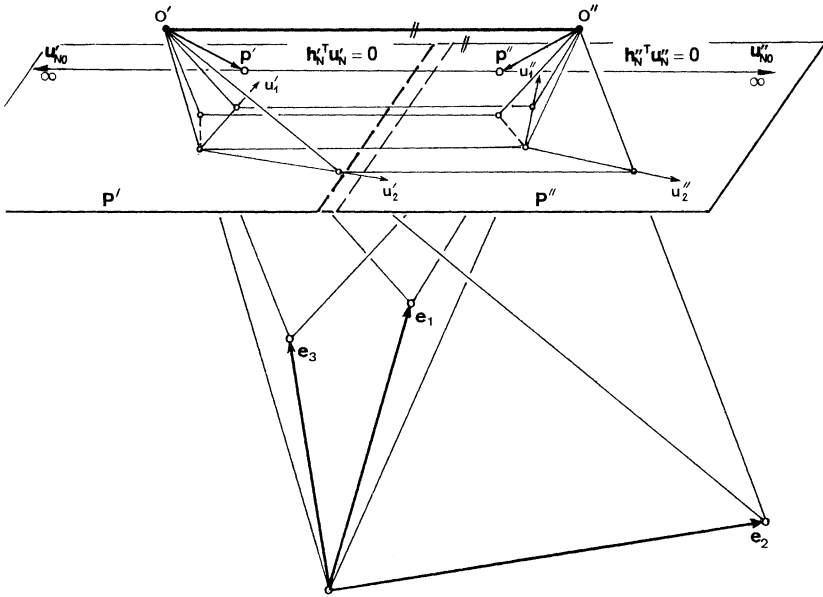

Fig. 3.2/1. Sketch of the projective normal case

indicating in this way the normal case of algebra-projective photogrammetry and justifying the choice of c_{10} in (2.2.1) as the probably largest component of \mathbf{C} . The vectors \mathbf{h}_N must now read symmetrically

$$\mathbf{h}'_N = \begin{bmatrix} -u''_{N1} - z_N u''_{N2} \\ 1 \\ z_N \end{bmatrix}, \quad \mathbf{h}''_N = \begin{bmatrix} -u'_{N1} + z_N u'_{N2} \\ -1 \\ -z_N \end{bmatrix} \quad (3.2.2)$$

and hence the equations of the epipolar lines

$$u'_{N1} + z_N u'_{N2} = u''_{N1} + z_N u''_{N2} \quad (3.2.3)$$

uniformly for both images. Thus the expression

$$z_N = -\frac{u'_{N1} - u''_{N1}}{u'_{N2} - u''_{N2}}$$

for the only factor $\neq 0$ or $\neq 1$ of image correlation is obtained, by which it may be computed from one additional pair of homologous points. But as, for the present problem, the fourth point is not yet available, another way of determining z_N must be found.

The parallelism of the epipolar lines is defined by $u_{N01} = u_{N02} = \infty$ or, projecting any point \mathbf{y}_A of the epipolar axis by means of equation (1.3.1), by the equations

$$u_{N0j} = \frac{\mathcal{Y}_{Aj}\mu_j + \mathcal{Y}_{A3}u_{N3j}\mu_3}{\mathcal{Y}_{A0} + \mathcal{Y}_{A1}\mu_1 + \mathcal{Y}_{A2}\mu_2 + \mathcal{Y}_{A3}\mu_3} = \infty. \quad j = 1, 2. \quad (3.2.4)$$

Since all quantities of the numerators are finite, this conditions are satisfied if the common denominator vanishes, that is

$$\mathcal{Y}_{A0} + \mathcal{Y}_{A1}\mu_1 + \mathcal{Y}_{A2}\mu_2 + \mathcal{Y}_{A3}\mu_3 = 0, \quad (3.2.5)$$

or in other words, one of the four parameters of the normal case must be a linear combination of the other three ($\mu_0 = 1$). Moreover, since in both images this fact exists with reference to the very same point \mathbf{y}_A , the projective parameters of \mathbf{P}'_N and \mathbf{P}''_N have to satisfy the conditions $\mu'_{Ni} = \mu''_{Ni}$, thus indicating the typical characteristic of the algebro-projective normal case. By means of the substitutions (1.3.5) the relations

$$\frac{u'_{N31}j'_{00}}{u'_{N30}j'_{01}} = \frac{u''_{N31}j''_{00}}{u''_{N30}j''_{01}}, \quad \frac{u'_{N32}j'_{00}}{u'_{N30}j'_{02}} = \frac{u''_{N32}j''_{00}}{u''_{N30}j''_{02}}, \quad \frac{j'_{00}}{u'_{N30}j'_{03}} = \frac{j''_{00}}{u''_{N30}j''_{03}}, \quad (3.2.6)$$

between the coordinates of the centers of projection, or, since those coordinates are already known from relative orientation, between the coordinates of G'_3 and G''_3 in P_{N3} are obtained.

Obviously, the postulation of parallelity to \mathbf{d} can only define one direction of the image plane P'_N and hence only one coordinate of G'_3 . Therefore a suitable assumption of the other coordinate will have to fix the second direction of the image plane. From Fig. 3.2/1 it can be seen that the coordinate u'_{N31} , more or less in transversal direction to \mathbf{d} , will be the appropriate quantity and its most convenient value will be that from the original image P' . In consequence, there can be introduced

$$u'_{N31} = u'_{31}.$$

Necessarily, there now exists relation to the second coordinate u'_{N32} . It arises from (3.2.5) by eliminating the μ_j by means of the terms (1.3.5) and takes the form

$$\left(\frac{\mathcal{Y}_{A1}}{j'_{01}} j'_{00} - \mathcal{Y}_{A0} \right) u'_{N31} + \left(\frac{\mathcal{Y}_{A2}}{j'_{02}} j'_{00} - \mathcal{Y}_{A0} \right) u'_{N32} = \frac{\mathcal{Y}_{A3}}{j'_{03}} j'_{00} - \mathcal{Y}_{A0}, \quad (3.2.7)$$

representing a condition between the two inhomogeneous components of \mathbf{u}'_{N3} . In this way the plane P'_N is uniquely defined and the coordinates u'_{N3} of G'_3 related to the normal case P'_N are known. Based on the

Thus they must satisfy the relation

$$\mathbf{h}'_{N0} \mathbf{w}'_0 = [0 \ 1 \ \xi_{N}] \begin{bmatrix} w'_{00} \\ w'_{01} \\ w'_{02} \end{bmatrix} = w'_{01} + \xi_{N} w'_{02} = 0$$

resulting in the expression

$$\xi_{N} = -\frac{w'_{01}}{w'_{02}} = -\frac{\mathcal{Y}_{A1}\mu'_1 + \mathcal{Y}_{A3}u'_{N31}\mu'_3}{\mathcal{Y}_{A2}\mu'_2 + \mathcal{Y}_{A3}u'_{N32}\mu'_3} = -\frac{u'_{N31}\mathcal{Y}'_{02}(\mathcal{Y}_{A1}\mathcal{Y}'_{03} - \mathcal{Y}'_{01}\mathcal{Y}_{A3})}{u'_{N32}\mathcal{Y}'_{01}(\mathcal{Y}_{A2}\mathcal{Y}'_{03} - \mathcal{Y}'_{02}\mathcal{Y}_{A3})} \quad (3.2.9)$$

for the determination of this important indicator of parallelism of base and image plane. If it is known there exists a second way of computing \mathbf{u}''_{N3} of P''_N using (3.2.3) and (3.2.7) by means of the two linear equations

$$u''_{N31} + \xi_{N}u''_{N32} = u'_{N31} + \xi_{N}u'_{N32} \quad (3.2.10)$$

$$\left(\frac{\mathcal{Y}_{A1}}{\mathcal{Y}_{01}} \mathcal{Y}''_{00} - \mathcal{Y}_{A0} \right) u''_{N31} + \left(\frac{\mathcal{Y}_{A2}}{\mathcal{Y}_{02}} \mathcal{Y}''_{00} - \mathcal{Y}_{A0} \right) u''_{N32} = \frac{\mathcal{Y}_{A3}}{\mathcal{Y}_{03}} \mathcal{Y}''_{00} - \mathcal{Y}_{A0},$$

containing the components of \mathbf{u}''_{N3} .

Since both centers of projection are already known from relative orientation, the μ''_j of P''_N may be computed by means of the relations (1.3.5) and must be equivalent with the μ'_j . As a proof, the resulting values must also satisfy the condition (3.2.9) with respect to P''_N .

In this way the components needed in (3.1.1) are given and the transformation to the normal case may be performed. But as the product of \mathbf{P}^*_N and \mathbf{P} must result in \mathbf{T} , it is more advantageous to determine its components t_{jk} directly according to (3.1.2). The necessary fourth points of this shortcut are the images \mathbf{u}'_{N3} and \mathbf{u}''_{N3} of G_3 resulting from the two possibilities mentioned above. Because of the initial assumption $u'_{N31} = u'_{31}$, the value of τ'_1 must result in u_{30}/u_{N30} . As a final check of the whole procedure the projective correlation from eight homologous points of the transformed images P'_N and P''_N must again yield the matrix \mathbf{Z}_N of (3.2.1).

All this clearly shows that the coordinates of the basic point G_3 of the model space are the determining parameters of orientation:

- if the centers of projection are known, these coordinates influence the parameters μ of the matrix of projection in accordance with (1.3.5);
- the procedure of relative orientation of subsection 2.3 obviously depends on their measured values;
- finally, they dominate the description of the normal case, or else, the establishing of parallelism to the base of the image plane.

Hence they replace, to some extent, the parameters of tip and tilt of traditional photogrammetry, whereas the parameter of swing is included more or less in the directions of the epipolar lines defined by \mathbf{z}_N (Fig. 3.2/2). The dependences of tip and tilt on G_3 clearly show the inherent restriction that algebroprojective photogrammetry is only practicable in connexion with evidently tridimensional models. This fact is also well-known from analytic photogrammetry, where the method of autocalibration, i.e. the simultaneous determination of interior (focal length and coordinates of the principal point) and exterior orientation cannot be performed by means of flat models; and since the use of quasihomogeneous vectors, containing the homogenizing constant component “1” instead of the focal length “c”, tacitly implies interior orientation, the limitations must be identic

3.3. A Less Complicated Normal Case Transformation

As already stated, the pure normal case transformation may be reduced to two bidimensional projective transformations $P' \rightarrow P'_n$ and $P'' \rightarrow P''_n$ ($P_n \equiv P'_n \equiv P''_n$), because the relations of these two projectivities read with respect to (3.1.1)

$$\tau' \mathbf{u}'_N = \mathbf{T}' \mathbf{u}' \quad \text{and} \quad \tau'' \mathbf{u}''_N = \mathbf{T}'' \mathbf{u}'' \quad (3.3.1)$$

As the coplanarity condition of two normal case images must read

$$\mathbf{u}'^T \mathbf{Z}_N \mathbf{u}'' = 0,$$

insertion of (3.3.1) yields

$$\mathbf{u}'^T \mathbf{T}'^T \mathbf{Z}_N \mathbf{T}'' \mathbf{u}'' = 0 \quad (3.3.2)$$

and hence a condition corresponding to (2.1.3). Therefrom results the relation

$$\mathbf{Z} = \mathbf{T}'^T \mathbf{Z}_N \mathbf{T}'' \quad (3.3.3)$$

between the correlation matrix \mathbf{Z} and the unknown projective matrices $\mathbf{T}^{(i)}$ to the right. The detailed evaluation produces

$$\begin{aligned} \begin{bmatrix} 0 & \mathbf{z}_{01} & \mathbf{z}_{02} \\ 1 & \mathbf{z}_{11} & \mathbf{z}_{12} \\ \mathbf{z}_{20} & \mathbf{z}_{21} & \mathbf{z}_{22} \end{bmatrix} &= \begin{bmatrix} 1 & 0 & 0 \\ \tau'_1 - 1 & \tau'_1 & 0 \\ \tau'_2 - 1 & 0 & \tau'_2 \end{bmatrix} \begin{bmatrix} 0 & -1 & -\mathbf{z}_w \\ 1 & 0 & 0 \\ \mathbf{z}_w & 0 & 0 \end{bmatrix} \begin{bmatrix} 1 & \tau''_1 - 1 & \tau''_2 - 1 \\ 0 & \tau''_1 & 0 \\ 0 & 0 & \tau''_2 \end{bmatrix} \\ &= \begin{bmatrix} 0 & & & -\tau''_2 \mathbf{z}_N \\ \tau'_1 & \tau'_1(\tau''_1 - 1) - \tau'_1(\tau'_1 - 1) & \tau'_1(\tau''_2 - 1) - \tau'_2(\tau'_1 - 1) \mathbf{z}_N & \\ \tau'_2 \mathbf{z}_N & \tau'_2 \mathbf{z}_N(\tau''_1 - 1) - \tau'_1(\tau'_2 - 1) & \tau'_2 \mathbf{z}_N(\tau''_2 - 1) - \tau'_2(\tau'_1 - 1) \mathbf{z}_N & \end{bmatrix} \end{aligned} \quad (3.3.4)$$

wherefrom, by comparison of components (first row and first column), the surprisingly simple relations

$$\tau'_1 = 1, \quad \tau'_2 = \frac{\tilde{\varkappa}_{20}}{\tilde{\varkappa}_{N}}, \quad \tau''_1 = -\varkappa_{01}, \quad \tau''_2 = -\frac{\tilde{\varkappa}_{02}}{\tilde{\varkappa}_{N}} \quad (3.3.5)$$

are obtained. Inserting these relations, the other components yield the following expressions:

- a) from the principal diagonal (positions (1, 1) and (2, 2)) arise

$$\varkappa_{01} = -1 - \varkappa_{11}, \quad \varkappa_{02} = -\varkappa_{20} - \varkappa_{22}$$

in correspondence with (2.2.2);

- b) the positions (1, 2) and (2, 1) produce two relations

$$\tilde{\varkappa}_{N} = -\frac{\tilde{\varkappa}_{02}}{1 + \varkappa_{12}} = \frac{\varkappa_{01} \tilde{\varkappa}_{20}}{\varkappa_{01} + \varkappa_{20} + \varkappa_{21} + \varkappa_{01} \varkappa_{20}} \quad (3.3.6)$$

for the determination of $\tilde{\varkappa}_{N}$. Their identity can be shown by means of the conditions of item a and the basic condition of \mathbf{Z} , that is

$$\det(\mathbf{Z}) = \varkappa_{01} \varkappa_{12} \varkappa_{20} + \varkappa_{02} \varkappa_{21} - \varkappa_{20} \varkappa_{11} \varkappa_{02} - \varkappa_{12} \varkappa_{01} = 0.$$

Elimination of $\tilde{\varkappa}_{N}$ in (3.3.4) by means of (3.3.5) furnishes the final expressions

$$\tau'_2 = \frac{\varkappa_{01}}{\varkappa_{01} + \varkappa_{20} + \varkappa_{21} + \varkappa_{01} \varkappa_{20}}, \quad \tau''_2 = \frac{1}{1 + \varkappa_{12}} \quad (3.3.7)$$

so that all five parameters ($\tilde{\varkappa}_{N}$, τ'_1 , τ'_2 , τ''_1 , τ''_2) of the projective transformation $P^{(i)} \rightarrow P^{(i)}_{N}$ can be composed completely and in a most uncomplicated way by the components of the matrix \mathbf{Z} .

The procedure of this subsection and the somewhat more complicated procedure of subsection 3.2 in connexion with the projective matrix (3.1.2) will result in different solutions with respect to the normal case. The difference is caused by the fact that in (3.1.2) the two parameters τ_i result generally from $\tau_i = u_{30} u_{N3i} / u_{N30} u_{3i}$ and hence the position (1, 0) of the matrix of correlation (3.3.4) in a component $\tilde{\varkappa}_{i0} \neq 1$ (!), whereas the present case corresponds with the method (1.5.4) of parameter determination, that is $\tau'_i = u'_{N3i} / u'_{N3i}$ and $\tau'_1 = 1$ because of $u'_{N31} = u'_{31}$. Both solutions are correct and select possible positions of the normal case plane out of a simple infinite manifold, in particular, since the values of the second solution arise from the first one by dividing all components by $\tilde{\varkappa}_{i0}$. With respect to a pure normal case transformation, this method is much shorter and therefore doubtlessly more expedient. The differences

between those two solutions will be visible from the numerical example of subsection 3.5.

The reconstruction of the (projectively distorted) spatial model from the projective normal case images of this subsection may be performed by calculating the parameters μ_N of relative orientation according to subsection 2.3. Again, the equations (2.3.0) may be used for this purpose. However, they are to be used in a modified way because the coordinates of the epipoles approach infinity as stated in (3.2.4). Hence the first equation of (2.3.0) equals 0, whereas the quotient of the other two equations must approach the value of ξ_N according to

$$\lim_{u_{01}, u_{02} \rightarrow \infty} \left(\frac{u_{01}}{u_{02}} \right) = \frac{u_{01}}{u_{02}} = -\xi_N$$

because of (2.3.9). By dividing all explicit expressions for μ of subsection 2.3 by u_{02} and performing the limiting process (3.3.7), that is, substituting the quotients u_{01}/u_{02} by $-\xi_N$ and ignoring all other values divided by u_{02} except the value $u_{02}/u_{02} = 1$, the following expressions will result:

a) left bundle

$$\begin{aligned} \mu'_{N1} &= \mu'_{N2} = -\mathcal{Y}_{A0} \mathcal{Y}_{A3} (u_{N31} + Z_N u_{N32}) / D'_N \\ \mu'_{N3} &= \mathcal{Y}_{A0} (\mathcal{Y}_{A1} + \xi_N \mathcal{Y}_{A2}) / D'_N \\ D'_N &= \mathcal{Y}_{A3} \{ (\mathcal{Y}_{A1} + \mathcal{Y}_{A2}) (u_{N31} + \xi_N u_{N32}) - \mathcal{Y}_{A1} - \xi_N \mathcal{Y}_{A2} \} \end{aligned} \quad (3.3.8)$$

b) right bundle:

$$\begin{aligned} D''_N &= \mathcal{Y}_{A1} \mathcal{Y}_{A2} (\xi_N - 1) \text{ because of } \lim_{u_{01}, u_{02} \rightarrow \infty} \left(\frac{u_{00}}{u_{02}} \right) = \xi_N - 1 \\ \mu''_{N1}(\mathbf{y}_A) &= \frac{1}{\mathcal{Y}_{A1} (\xi_N - 1)} \{ \mathcal{Y}_{A3} [u''_{N31} + \xi_N u''_{N32} - \xi_N] \mu''_{N3} - \xi_N \mathcal{Y}_{A0} \}, \\ \mu''_{N2}(\mathbf{y}_A) &= \frac{1}{\mathcal{Y}_{A2} (\xi_N - 1)} \{ \mathcal{Y}_{A3} [1 - u''_{N31} - \xi_N u''_{N32}] \mu''_{N3} + \mathcal{Y}_{A0} \}, \\ \mu''_{N1}(\mathbf{y}_0) &= \frac{1}{\mathcal{Y}_{01} (\xi_N - 1)} \{ \mathcal{Y}_{03} [u''_{N31} + \xi_N u''_{N32} - \xi_N] \mu''_{N3} - \xi_N \mathcal{Y}_{00} \}, \\ \mu''_{N2}(\mathbf{y}_0) &= \frac{1}{\mathcal{Y}_{02} (\xi_N - 1)} \{ \mathcal{Y}_{03} [1 - u''_{N31} - \xi_N u''_{N32}] \mu''_{N3} + \mathcal{Y}_{00} \}, \\ (\mathcal{Y}_{01} \mathcal{Y}_{A3} - \mathcal{Y}_{A1} \mathcal{Y}_{03}) (u''_{N31} + \xi_N u''_{N32} - \xi_N) \mu''_{N3} &= -\xi_N (\mathcal{Y}_{00} \mathcal{Y}_{A1} - \mathcal{Y}_{01} \mathcal{Y}_{A0}) \\ (\mathcal{Y}_{02} \mathcal{Y}_{A3} - \mathcal{Y}_{A2} \mathcal{Y}_{03}) (u''_{N31} + \xi_N u''_{N32} - 1) \mu''_{N3} &= -(\mathcal{Y}_{00} \mathcal{Y}_{A2} - \mathcal{Y}_{02} \mathcal{Y}_{A0}) \end{aligned} \quad (3.3.9)$$

Knowing all μ_N which have to satisfy the conditions $\mu'_{N\bar{i}} = \mu''_{N\bar{i}}$, the reconstruction itself follows from the application of equations (2.3.4). The transition to a cartesian system of representation will then be achieved by a regular projective 3D-transformation corresponding to (1.5.2).

3.4. Representation of Output Images

The transformations (3.3.1) with \mathbf{T} according to (3.1.2) or (3.3.4) will produce the numerical values of the affine normal case coordinates of image points, but they cannot be plotted or displayed without positions of the basic points $G_{N\bar{i}}$ in the rectangular coordinate system of the output device. To solve this problem, the already mentioned “natural” orthogonal axes \mathbf{g}_0 and \mathbf{h}_p may be used, but as, in the normal case, all epipolar lines are parallel, every \mathbf{h}_N is suitable for this purpose. Hence, a right-angled image frame can be established in the oblique-angled affine coordinate system of the images using selected members of the parallel line families

$$\mathbf{g}_{N0}^T \mathbf{u}_N = g_{N0} + (\tau_1 - 1)u_{N1} + (\tau_2 - 1)u_{N2} = 0$$

and

$$\mathbf{h}_{N0}^T \mathbf{u}_N = h_{N0} + u_{N1} + \varkappa_N u_{N2} = 0$$

Those selected lines will be the epipolar lines \mathbf{h}_{N0} , \mathbf{h}_{N1} passing through G_{N0} and G_{N1} and the parallels to the vanishing line \mathbf{g}_{N0} , \mathbf{g}_{N2} passing through G_{N0} and G_{N2} (Fig. 4.2). They read:

$$\mathbf{h}_{N0}^T \mathbf{u}_N = u_{N1} + \varkappa_N u_{N2} = 0$$

$$\mathbf{h}_{N1}^T \mathbf{u}_N = u_{N1} + \varkappa_N u_{N2} = 1$$

$$\mathbf{g}_{N0}^T \mathbf{u}_N = (\tau_1 - 1)u_{N1} + (\tau_2 - 1)u_{N2} = 0$$

$$\mathbf{g}_{N2}^T \mathbf{u}_N = (\tau_1 - 1)u_{N1} + (\tau_2 - 1)u_{N2} = (\tau_2 - 1).$$

The coordinates of their four points of intersection may be gathered from Table 3.4 where $\delta = \varkappa_N(\tau_1 - 1) - (\tau_2 - 1)$. They depend exclusively on the projective parameters $\tau_1, \tau_2, \varkappa_N$ of the normal case transformation and define the parameters of the affine transformation

$$\mathbf{x} = \mathbf{A}\mathbf{u}_N, \quad \mathbf{A} = \begin{bmatrix} 1 & 0 & 0 \\ a_{10} & a_{11} & a_{12} \\ a_{20} & a_{21} & a_{22} \end{bmatrix}$$

from the oblique system of calculation to the rectangular but still affine system of an output device. The transformation with respect to $U_0(0, 0)$

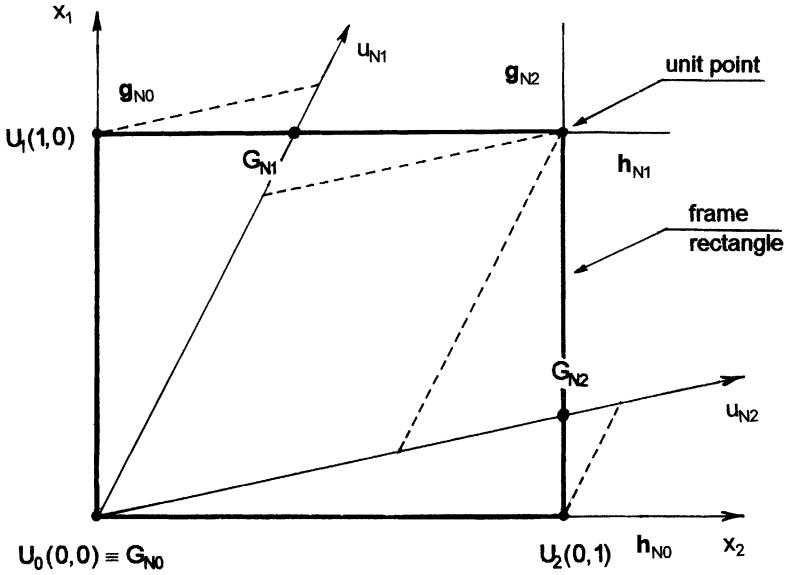

Fig. 3.4. Affine transformation from oblique to rectangular image coordinates

 Table 3.4. Coordinates of the frame rectangle from intersections $\mathbf{g}_{Ni} - \mathbf{h}_{Ni}$

lines	$U_0 \equiv \text{origin}$ $\mathbf{g}_{N0} - \mathbf{h}_{N0}$	U_1 $\mathbf{g}_{N0} - \mathbf{h}_{N1}$	unit point $\mathbf{g}_{N2} - \mathbf{h}_{N1}$	U_2 $\mathbf{g}_{N2} - \mathbf{h}_{N0}$
u_{N1}	0	$-(\tau_2 - 1)/\delta$	$(\tau_2 - 1)(\xi_N - 1)/\delta$	$\xi_N(\tau_2 - 1)/\delta$
u_{N2}	0	$(\tau_1 - 1)/\delta$	$(\tau_1 - \tau_2)/\delta$	$-(\tau_2 - 1)/\delta$

(Fig. 3.4) will result in $a_{10} = a_{20} = 0$ (no translation), the transformation with respect to the other two points $U_1(1, 0)$ and $U_2(0, 1)$ yields

$$\left. \begin{aligned} -(\tau_2 - 1)a_{11} + (\tau_1 - 1)a_{12} &= \delta \\ \xi_N(\tau_2 - 1)a_{11} - (\tau_2 - 1)a_{12} &= 0 \end{aligned} \right\} \Rightarrow a_{11} = 1, a_{12} = \xi_N$$

$$\left. \begin{aligned} -(\tau_2 - 1)a_{21} + (\tau_1 - 1)a_{22} &= 0 \\ \xi_N(\tau_2 - 1)a_{21} - (\tau_2 - 1)a_{22} &= \delta \end{aligned} \right\} \Rightarrow a_{21} = \frac{\tau_1 - 1}{\tau_2 - 1}, a_{22} = 1.$$

The affine transformation to the output system reads therefore

$$\begin{aligned} \begin{bmatrix} 1 \\ x_1 \\ x_2 \end{bmatrix} &= \begin{bmatrix} 1 & 0 & 0 \\ 0 & 1 & \tilde{x}_N \\ 0 & (\tau_1 - 1)/(\tau_2 - 1) & 1 \end{bmatrix} \begin{bmatrix} 1 \\ u_{N1} \\ u_{N2} \end{bmatrix} \\ &= \begin{bmatrix} 1 \\ u_{N1} + \tilde{x}_N u_{N2} \\ (\tau_1 - 1)u_{N1}/(\tau_2 - 1) + u_{N2} \end{bmatrix} \end{aligned} \quad (3.4.1)$$

and shows the important fact that the fundamental normal case condition $u'_{N1} + \tilde{x}_N u'_{N2} = u''_{N1} + \tilde{x}_N u''_{N2}$ will not be influenced by this necessary conversion to rectangular coordinates. This condition of course means $x'_1 = x''_1$ and ensures the absence of vertical parallax after transformation. As a control, the transformation of the affine coordinates of the “unit point” results in $\mathbf{x}^T = (1, 1, 1)$.

It must be pointed out clearly that the relation between horizontal and vertical scale is not known due to the arbitrary introduction of U_2 as a unit point on the horizontal coordinate axis. But for a pure, undisturbed spatial impression the horizontal scale does not have any significance, and if the cartesian model is to be reconstructed, the elimination of this additional affine distortion will be included in the regular projective transformation (1.5.2) based on five control points.

4. Numerical Examples

All initial coordinates of the following examples refer to an assumed cartesian model [2]. They will be firstly transformed into the system of the basic points and then to the normal case. After relative orientation for both cases, a reconstruction will be calculated which can be compared directly with the initial affine model coordinates.

a. Computation of the Spatial Model from Assumed Data

Nr.	Cartesian coordinates [m]			Affine coordinates		
	X	Y	Z	J_1	J_2	J_3
1	292.50	202.50	120.00	-0.0000000	-0.0000000	0.0000000
2	435.00	900.00	990.00	-0.0000000	0.0000000	1.0000000
3	660.00	1537.50	312.00	0.5756072	0.1487681	0.1279697
4	577.50	2295.00	91.50	1.0000000	0.0000000	0.0000000
5	1537.50	480.00	772.50	-0.0000000	1.0000000	0.0000000
6	1357.50	1057.50	138.00	0.4912043	0.8981410	-0.5693249

Nr.	Cartesian coordinates [m]			Affine coordinates		
	X	Y	Z	J_1	J_2	J_3
7	1717.50	1695.00	247.50	0.7775096	1.0358235	-0.6048458
8	1462.50	2115.00	975.00	0.6654715	0.7355879	0.4528676
O'	367.50	1261.50	3712.50	0.8871075	-0.2253355	4.2692516
O''	1612.50	1192.50	3987.00	0.9009221	0.8325803	3.7908794
11	300.00	225.00	142.50	0.0024264	0.0027341	0.0238910
12	532.50	999.00	517.50	0.2367270	0.0934168	0.3945888
13	1048.50	684.00	867.00	0.0088907	0.5544832	0.4430495
14	1359.00	1267.50	417.00	0.4805426	0.7720203	-0.2218940
15	1660.50	1509.00	799.50	0.4742924	0.9834730	0.0589669
16	1504.50	2068.50	648.00	0.7739665	0.7919375	0.0382975

b. Computation of Image Coordinates

Assumed matrices of orientation:

$$R' = \begin{bmatrix} 0.99564508 & -0.09007407 & 0.02403194 \\ 0.09096120 & 0.99509814 & -0.03880383 \\ -0.02041892 & 0.04082082 & 0.99895782 \end{bmatrix},$$

$$R'' = \begin{bmatrix} 0.99817506 & 0.05377542 & -0.0274727873 \\ -0.05336033 & 0.99845306 & 0.0156255137 \\ 0.02827056 & -0.01413104 & 0.9995004198 \end{bmatrix}$$

By means of these orientations the cartesian coordinates of the spatial model are projected to image planes P' , P'' with respect to the two centers of projection O' and O'' . The results are given below.

Nr.	Cartesian coordinates [dm]			Affine coordinates				
	x'	y'	x''	y''	u'_1	u'_2	u''_1	u''_2
1	-0.0451870	-0.6343754	-0.8130548	-0.6290877	0.0000000	0.0000000	0.0000000	0.0000000
2	0.0313810	-0.2265744	-0.9164214	-0.2281625	0.2718578	0.0577379	0.3094497	-0.2327183
3	0.1361022	0.3193167	-0.5609002	0.2279833	0.6355182	0.1372296	0.6442013	0.1043779
4	0.0202372	0.8297962	-0.5502266	0.6951777	1.0000000	0.0000000	1.0000000	1.0000000
5	0.9728948	-0.4654293	-0.0193972	-0.5909803	0.0000000	1.0000000	0.0000000	1.0000000
6	0.6377332	0.0178894	-0.1012696	-0.1176720	0.3708332	0.6469605	0.3638478	0.7763495
7	0.8799424	0.4959498	0.1567209	0.2924344	0.6721215	0.8655064	0.6670692	1.0009998
8	0.8702316	0.9690304	-0.0143426	0.7282690	0.9987487	0.8349783	1.0056120	0.6733496
O'			-9.9141575	1.0549357			1.6170618	-12.0027987
O''	-12.7287969	-0.3448844			1.6474603	-12.5642098		
11	-0.0413327	-0.6230778	-0.8125383	-0.6182340	0.0073336	0.0033146	0.0082560	-0.0020832
12	0.0866752	-0.09553180	-0.7102699	-0.1357322	0.3558592	0.1066519	0.3723722	0.0061928
13	0.5743628	-0.3492243	-0.4033963	-0.4207995	0.1254647	0.6004836	0.1438029	0.4685434
14	0.6849534	0.1691064	-0.1055003	0.0228084	0.4694911	0.6870021	0.4711043	0.7354998
15	1.0209872	0.4074610	0.1195522	0.2066799	0.5951289	1.0089939	0.6030505	0.9753681
16	0.8075429	0.8400414	0.0231421	0.6175757	0.9171517	0.7796466	0.9198471	0.7489819

c. Result of Correlation with Affine Coordinates (points 1 to 8)

$$\mathbf{Z} = \begin{bmatrix} 0.00000000 & -0.97340074 & -0.13114018 \\ 1.00000000 & -0.02659926 & 0.07973035 \\ 0.13112327 & -0.08096187 & 0.00001691 \end{bmatrix},$$

$$\det(\mathbf{Z}) = 0.0000000000$$

Epipoles:

$$\text{in } P' \text{ from } \mathbf{Z}^T \mathbf{u}'_0 = \mathbf{0}: \quad u'_{01} = 1,64746, \quad u'_{02} = -12.56421$$

$$\text{in } P'' \text{ from } \mathbf{Z} \mathbf{u}''_0 = \mathbf{0}: \quad u''_{01} = 1.61706, \quad u''_{02} = -12.00280$$

d. Relative Orientation of the Two Projective Bundles

Assumption of one point at the epipolar axis: $\mathbf{y}'_A = (-1.0, 0.5, 3.5)$.
Projective parameters of P' from Eq. (3.2.2):

$$\mu'_0 = 1.0 \quad \mu'_1 = \mu'_2 = 0.6898293 \quad \mu'_3 = 0.6591033$$

Center of projection according to subsection 1.3:

$$y'_{01} = -1.0679613 \quad y'_{02} = -0.2268166 \quad y'_{03} = 4.1115155$$

Projective parameters of P'' according to (3.2.4) and (3.2.3):

$$\mu''_0 = 1.0 \quad \mu''_1 = 0.7086797 \quad \mu''_2 = 0.6897404 \quad \mu''_3 = 0.6803561$$

Center of projection:

$$y''_{01} = -0.9762202 \quad y''_{02} = 0.7543148 \quad y''_{03} = 3.2860293$$

e. Projectively Distorted Model from Relatively Oriented Images and Projective Transformation

Nr.	Relative model \bar{M}			Transformation $\bar{M} \rightarrow M$		
	\bar{y}_1	\bar{y}_2	\bar{y}_3	y_1	y_2	y_3
1	-0.0000000	-0.0000000	0.0000000	-0.0000000	-0.0000000	0.0000000
2	-0.0000000	0.0000000	1.0000000	-0.0000000	0.0000000	1.0000000
3	0.6355543	0.1373416	0.1130328	0.5756072	0.1487681	0.1279697
4	1.0000000	0.0000000	0.0000000	1.0000000	0.0000000	0.0000000
5	-0.0000000	1.0000000	0.0000000	-0.0000000	1.0000000	0.0000000
6	0.5455624	0.7504735	-0.5058402	0.4912043	0.8081410	-0.5693249
7	0.7668908	0.8542391	-0.4772471	0.7775096	1.0358235	-0.6048458
8	0.6366276	0.5883781	0.3465757	0.6654715	0.7355879	0.4528676

Nr.	Relative model \bar{M}			Transformation $\bar{M} \rightarrow M$		
	\bar{J}_1	\bar{J}_2	\bar{J}_3	J_1	J_2	J_3
11	0.0034507	0.0032510	0.0271793	0.0024264	0.0027341	0.0238910
12	0.2876072	0.0948949	0.3835020	0.2367270	0.0934168	0.3945888
13	0.0108103	0.5637081	0.4309463	0.0088907	0.5544832	0.4430495
14	0.5183431	0.6962739	-0.1914705	0.4805426	0.7720203	-0.2218940
15	0.4828822	0.8371888	0.0480258	0.4742924	0.9834730	0.0589669
16	0.7413441	0.6342413	0.0293453	0.7739665	0.7919375	0.0382975

Matrix of transformation $\bar{M} \rightarrow M$ (basic points 1-4-5-2, fifth point 13)

$$\mathbf{M} = \begin{bmatrix} 1.175435236 & -0.353003193 & -0.191800001 & -0.147350009 \\ 0.000000000 & 0.822432042 & 0.000000000 & 0.000000000 \\ 0.000000000 & 0.000000000 & 0.983635234 & 0.000000000 \\ 0.000000000 & 0.000000000 & 0.000000000 & 1.028085227 \end{bmatrix}$$

f. First Transformation to the Normal Case (subsection 3.2)

Coordinates of G'_3 (= point 2):

$$u'_{N31} = 0.2718578 \quad u'_{N32} = 0.0619863$$

Center of projection of P'_N (equal to P'):

$$y'_{01} = -1.0679613 \quad y'_{02} = -0.2268166 \quad y'_{03} = 4.1115155$$

Projective parameters of P'_N according to (1.3.5):

$$\mu'_{N0} = 1.0 \quad \mu'_{N1} = 0.6942287 \quad \mu'_{N2} = 0.7453105 \quad \mu'_{N3} = 0.6633067$$

Computation of \varkappa_N :

$$w_{01} = -0.0630909 \quad w_{02} = 0.5165610 \quad \Rightarrow \varkappa_N = \mathbf{0.1221364}$$

Coordinates of G'_3 from (3.3.8):

$$u''_{N31} = 0.3109314 \quad u''_{N32} = -0.2579313$$

Center of projection of P''_N (equal to P''):

$$y''_{01} = -0.9762202 \quad y''_{02} = 0.7543148 \quad y''_{03} = 3.2860293$$

Projective parameters of P''_N according to (1.3.5):

$$\mu''_{N0} = 1.0 \quad \mu''_{N1} = 0.6942287 \quad \mu''_{N2} = 0.7453105 \quad \mu''_{N3} = 0.6633067$$

The values of the μ_N satisfy the condition of the normal case, that is $\mu'_{Ni} = \mu''_{Ni}$!

g. Transformed Affine Coordinates

Matrices of projective normal case transformation

$$\mathbf{T}' = \begin{bmatrix} 1.0000000 & 0.0063775 & 0.0804274 \\ 0.0000000 & 1.0063775 & 0.0000000 \\ 0.0000000 & 0.0000000 & 1.0804274 \end{bmatrix},$$

$$\mathbf{T}'' = \begin{bmatrix} 1.0000000 & -0.0203914 & 0.0805667 \\ 0.0000000 & 0.9796086 & 0.0000000 \\ 0.0000000 & 0.0000000 & 1.0805667 \end{bmatrix}$$

Nr.	u'_{N1}	u'_{N2}	u''_{N1}	u''_{N2}
1	0.00000000	0.00000000	0.00000000	0.00000000
2	0.27185777	0.06198631	0.31093136	-0.25793130
3	0.63006349	0.14606252	0.63406219	0.11332295
4	1.00000000	-0.00000000	1.00000000	-0.00000000
5	-0.00000000	1.00000000	-0.00000000	1.00000000
6	0.35394418	0.66293147	0.33780566	0.79506665
7	0.62986306	0.87076971	0.61240793	1.01368482
8	0.93627862	0.84034725	0.95295006	0.70384877
11	0.00737807	0.00358002	0.00809035	-0.00225186
12	0.35428572	0.11399317	0.36738529	0.00673955
13	0.12035589	0.61841740	0.13613094	0.48925808
14	0.44647879	0.70140071	0.43966816	0.75716320
15	0.55203140	1.00479146	0.55402949	0.98843197
16	0.86384988	0.78735789	0.86511348	0.77701207

Control: matrix of normal case correlation (points 1 to 8):

$$\mathbf{Z}_N = \begin{bmatrix} 0.0000000 & -1.0000000 & -0.1221364 \\ 1.0000000 & 0.0000000 & 0.0000000 \\ 0.1221364 & 0.0000000 & 0.0000000 \end{bmatrix}$$

h. Reconstruction of $\bar{\mathbf{M}}$ from Normal Case

Nr.	\bar{y}_1	\bar{y}_2	\bar{y}_3	Nr.	\bar{y}_1	\bar{y}_2	\bar{y}_3
1	-0.00000000	-0.00000000	0.00000000	8	0.6366276	0.5883781	0.3465757
2	-0.00000000	0.00000000	1.00000000	11	0.0034507	0.0032510	0.0271793
3	0.6355543	0.1373416	0.1130328	12	0.2876072	0.0948949	0.3835020
4	1.00000000	0.00000000	0.00000000	13	0.0108103	0.5637081	0.4309463
5	-0.00000000	1.00000000	0.00000000	14	0.5183431	0.6962739	-0.1914705
6	0.5455624	0.7504735	-0.5058402	15	0.4828822	0.8371888	0.0480258
7	0.7668908	0.8542391	-0.4772471	16	0.7413441	0.6342413	0.0293453

The projectively distorted coordinates are exactly equivalent to those of direct reconstruction.

i. Second Normal Case Transformation (subsection 3.3)

From \mathbf{Z} of item c) the projective parameters $\mathbf{z}_N = \mathbf{0.12145642}$, $\tau'_1 = 1$, $\tau'_2 = 1.07959100$, $\tau''_1 = 0.97340080$ and $\tau''_2 = 1.07973000$ were calculated using (3.3.5), (3.3.6) and (3.31.7). The projective matrices according to (3.3.3) read

$$\mathbf{T}' = \begin{bmatrix} 1.00000000 & 0.00000000 & 0.07959116 \\ 0.00000000 & 1.00000000 & 0.00000000 \\ 0.00000000 & 0.00000000 & 1.07959100 \end{bmatrix},$$

$$\mathbf{T}'' = \begin{bmatrix} 1.00000000 & -0.02659926 & 0.07973035 \\ 0.00000000 & 0.97340080 & 0.00000000 \\ 0.00000000 & 0.00000000 & 1.07973000 \end{bmatrix}$$

and the results of the transformations (3.3.1) are the affine normal case coordinates $\mathbf{u}'_N, \mathbf{u}''_N$ to the left of the following table. The centers of projection and the projective parameters result from (3.3.8) and (3.3.9) in

$$\begin{array}{lll} \mu'_{N1} = 0.6952050 & \mu'_{N2} = 0.6952050 & \mu'_{N3} = 0.67074357 \\ y'_{01} = -1.1281689 & y'_{02} = -0.2586740 & y'_{03} = 4.3209568 \\ \mu''_{N1} = 0.6952050 & \mu''_{N2} = 0.6952050 & \mu''_{N3} = 0.67074358 \\ y''_{01} = -0.9505164 & y''_{02} = 0.7929098 & y''_{03} = 3.1830439 \end{array}$$

Nr.	u'_{N1}	u'_{N2}	u''_{N1}	u''_{N2}	z_N	X'_1	X'_2	X''_1	X''_2	p
1	0.000000	0.000000	0.000000	0.000000		100.0	100.0	100.0	145.7	45.7
2	0.270614	0.062048	0.309509	-0.258189	0.121456	171.2	115.9	171.2	53.2	62.7
3.	0.628652	0.146551	0.632642	0.113702	0.121457	265.5	137.5	265.5	120.8	16.7
4	1.000000	0.000000	1.000000	0.000000		356.0	100.0	356.0	60.3	39.7
5	0.000000	1.000000	0.000000	1.000000		131.1	356.0	131.1	401.7	-45.7
6	0.352673	0.664249	0.336593	0.796647	0.121456	210.9	270.0	210.9	320.9	-50.8
7	0.628805	0.874174	0.611379	1.017648	0.121456	288.2	323.8	288.2	354.0	-30.2
8	0.936511	0.845262	0.953187	0.707965	0.121457	366.0	316.4	366.0	245.5	70.9
O'	∞		∞	∞		∞		∞	∞	
O''	∞	∞				∞	∞			
11	0.007332	0.003577	0.008039	-0.002250	0.121456	102.0	100.9	102.0	144.4	-43.5
12	0.352864	0.114171	0.365911	0.006750	0.121457	193.9	129.2	193.9	116.2	13.1
13	0.119742	0.618707	0.135436	0.489487	0.121456	149.9	258.4	149.9	259.4	-1.1
14	0.445151	0.703229	0.438360	0.759137	0.121456	235.8	280.0	235.8	302.6	-22.6
15	0.550889	1.008325	0.552883	0.991908	0.121458	272.4	358.1	272.4	352.4	5.7
16	0.863630	0.791564	0.864893	0.781163	0.121459	345.7	302.6	345.7	271.8	30.8

The matrices of the affine transformations to rectangular image coordinates read

$$\mathbf{A}' = \begin{bmatrix} 1 & 0 & 0 \\ 0 & 1 & 0.121456 \\ 0 & 0 & 1 \end{bmatrix}, \quad \mathbf{A}'' = \begin{bmatrix} 1 & 0 & 0 \\ 0 & 1 & 0.121456 \\ 0 & -0.333615 & 1 \end{bmatrix}$$

and the resulting values, adapted in scale to a 512×512 pixel image field, can be seen to the right of the Table. Its last column contains the horizontal parallaxes. The transformed image points are mapped in the lower part of Fig. 3.5 with additively modified x_2'' -coordinates ($\Delta x_2'' = 45.4$) in order to get reasonable horizontal parallaxes. Everybody

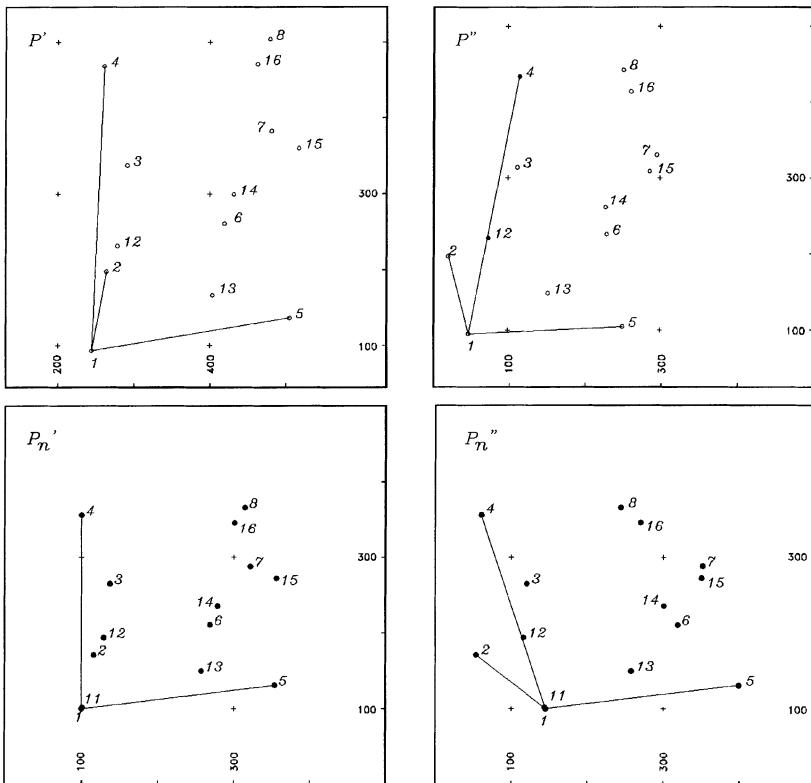

Fig. 3.5. Upper part: original “images” with coordinates of item b), lower part: normal case representation

who is able to connect the images of a stereo pair without stereoscopic glasses will get a spatial impression of the point distribution.

5. Final Remarks

In comparison with traditional photogrammetry, the application of algebroprojective methods has its advantages and drawbacks. The major advantages are:

- ⇒ complete linearity of all projective relations and
- ⇒ no need for knowledge about interior orientation;

The drawbacks, on the other hand, are:

- ⇒ unusual affine geometry with more unknowns and
- ⇒ the need for more control points with respect to absolute orientation.

But regarding the power of modern calculational and measuring techniques, however, advantages and drawbacks will be in equilibrium and the decision between analytical and/or algebroprojective methods should depend on the character of the respective photogrammetric problem to be solved.

Obviously, in the preceding considerations, several additional problems remain to be investigated. An incomplete list of them should contain:

- ⇒ relative orientation of stereo images of a *plane* object
- ⇒ how to derive relative orientation from the projective relations of the normal case transformation according to subsection 3.3
- ⇒ multiple correlation and relative orientation in connexion with image triangulation
- ⇒ algebroprojective error calculation and propagation
- ⇒ critical configurations with respect to image correlation (subsection 2.3)
- ⇒ how to introduce optical distortion and other deformations of the projective bundles
- ⇒ sensitivity and stability of numerical solutions.

Theoretical research in these extremely interesting topics presupposes a proper ability of geometric imagination and a certain patience for somewhat complicated derivations. But the majority of the resulting relations, however, is very uncomplicated, and this gratifying simplicity will justify all preceding efforts.

References

- [1] Brandstätter, G.: On the Importance of Projective Geometry for Analytical and Digital Photogrammetric Restitution. Symp. ISPRS Comm. VI, Int. Arch. of Ph. & R. S., Vol. 28, Part. 6, Rhodos 1990, pp. 187–193
- [2] Brandstätter, G.: Zur relativen Orientierung projektiver Bündel. Zeitschrift für Photogrammetrie und Fernerkundung, 59. Jg. Heft 6, Karlsruhe 1991, pp. 199–212
- [3] Brandstätter, G.: Notes on the projective transformation of general stereo pairs into the rigorous normal case by image correlation. XVII ISPRS Congress, Comm. III, Washington 1992, pp. 701–706
- [4] Brandstätter, G.: Transformation to the Normal Case of General Non-Calibrated Projective Stereo Pairs. 2nd Conf. on Optical 3-D Meas. Techn., Zürich 1993, Verl. Wichmann Karlsruhe, pp. 231–238
- [5] Brandstätter, G.: On a Most Uncomplicated Method of Projective Normal Case Transformation. Zeitschrift für Photogrammetrie und Fernerkundung, 63. Jg. Heft 5., Karlsruhe 1995, pp. 189–199
- [6] Bronstein, I. N. u., K. A. Semendjajew.: Taschenbuch der Mathematik VEB Edition Leipzig 1961, p. 451 ff.
- [7] Fuchs H.: Projektive Geometrie; Anwendungen in Photogrammetrie und Robotik. Mittlgn. der geodät. Inst. d. TU Graz, Folge 63, Graz 1988
- [8] Haggren H., u.I. Niini.: Relative Orientation Using 2-D Projective Transformations. The Photogrammetric Journal of Finland, Vol. 12, No. 1, 1990, pp. 22–33
- [9] Hohenberg F., u. J. P. Tschupik.: In Handbuch der Vermessungskunde J/E/K Band IIIa/3, Photogrammetrie. J. B. Metzler, Stuttgart 1972, p. 2248 ff.
- [10] Klein, F.: Elementarmathematik vom höheren Standpunkt aus. Teil II: Geometrie. B. G. Teubner, Leipzig 1909, p. 225 ff.
- [11] Krames, J.: Über die bei der Hauptaufgabe der Luftphotogrammetrie auftretenden “gefährlichen Flächen”. Bildmessung und Luftbildwesen, 1/2, 1942, pp. 1–18
- [12] Kreiling W.: Automatische Herstellung von Höhenmodellen und Orthophotos aus Stereobildern durch digitale Korrelation. Dissertation Universität Karlsruhe 1976
- [13] Niini I.: Solution of the Interior Orientation without Control Points. The Photogrammetric Journal of Finland, Vol. 13, No. 2, 1993, pp. 78–84
- [14] Rinner K.: Studien über eine allgemeine voraussetzungslose Lösung des Folgebildanschlusses. Österreichische Zeitschr. f. Vermwesen u. Photogr., Sonderheft 23, Wien 1963
- [15] Rinner K.: In Handbuch der Vermessungskunde J/E/K Band IIIa/1, Photogrammetrie, J. B. Metzler, Stuttgart 1972
- [16] Thompson E. H.: The Projective Theory of Relative Orientation. Photogrammetria, Vo. 23, 1968, pp. 67–75
- [17] Wrobel, B.: Minimum Solutions for Orientation In “Calibration and Orientation of Cameras in Computer Vision” Editors Th. Huang/A. Gruen, Springer-Verlag.
- [18] Wunderlich W.: Zur Eindeutigkeitsfrage der Hauptaufgabe der Photogrammetrie. Monatshefte für Mathematik und Physik, 50. Bd. 1941, pp. 151–184

Author’s address: Prof. Dr. Gerhard Brandstätter, Abteilung für Fernerkundung, Bildverarbeitung und Kartographie, TU Graz, Steyrergasse 30, A-8010 Graz.