

Tafel 1

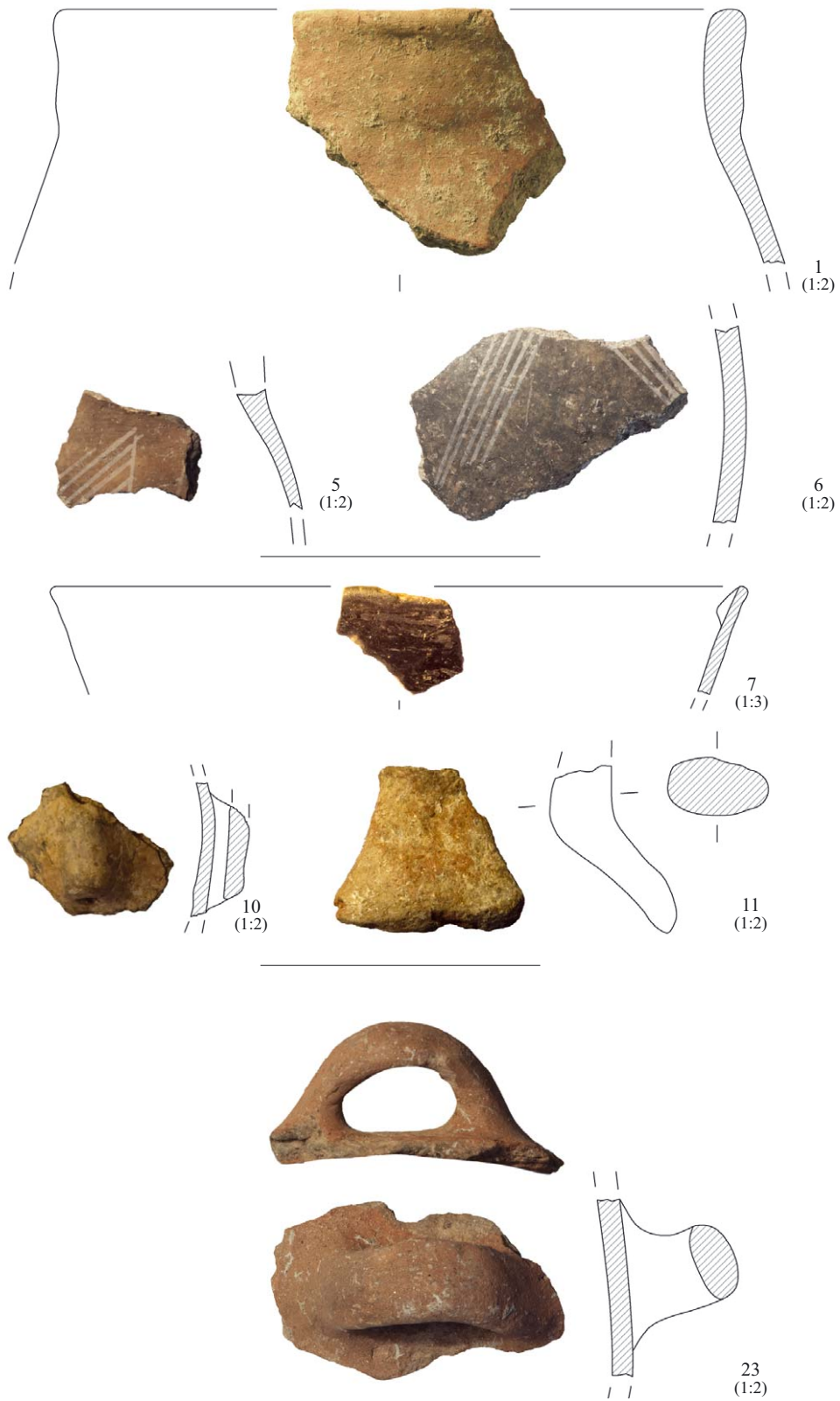

ÇuHö VII Grabenverfüllung A: SE 1254 (1, 5-6); SE 1335 (7, 10-11); SE 1351 (23)

Tafel 2

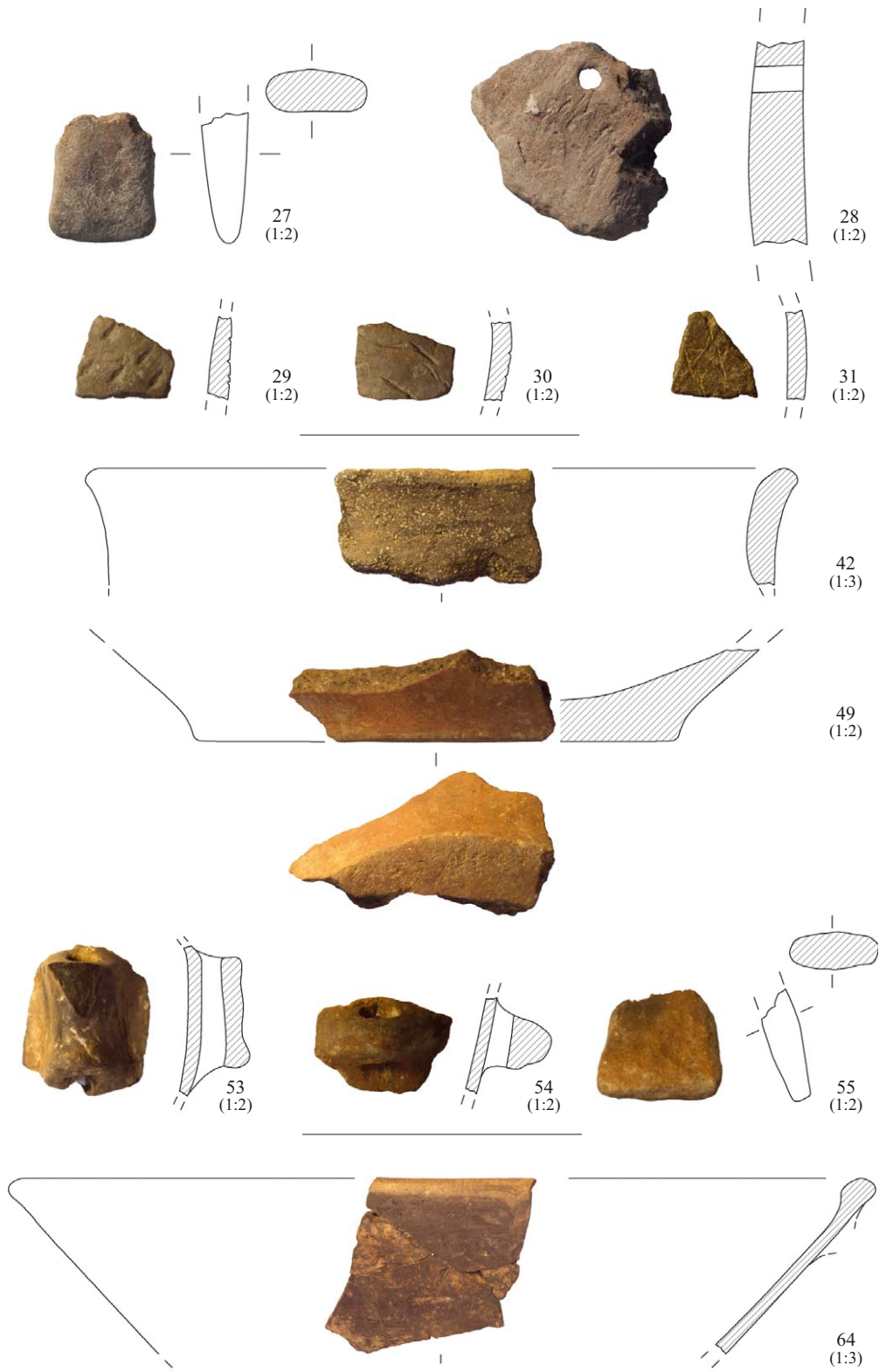

ÇuHö VII Grabenverfüllung A: SE 1351 (27–31); Grabenverfüllung B: SE 4553 (42, 49, 53–55)
 Planierung ÇuHö VIb/VII Grabenverfüllung C: SE 1218 (64)

Tafel 3

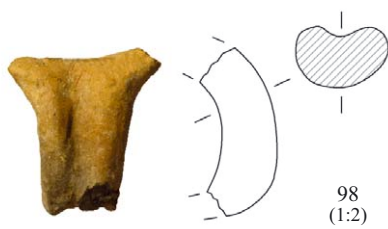
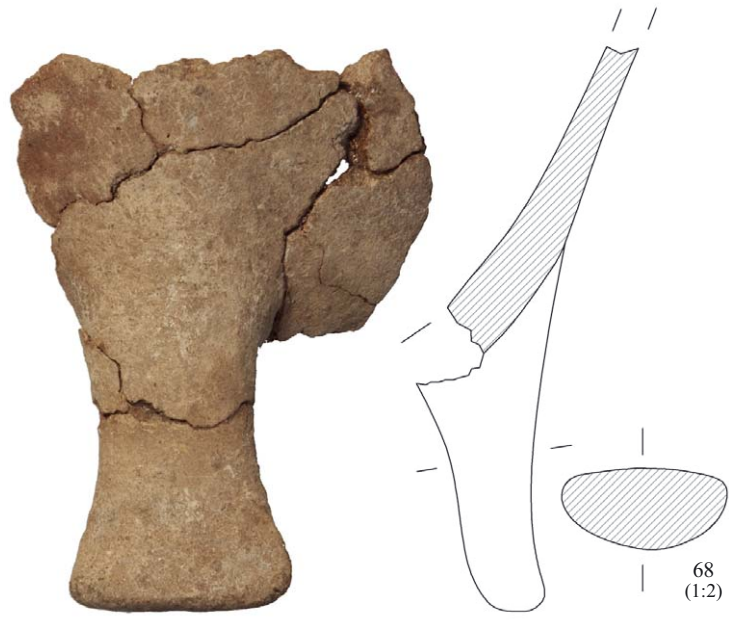
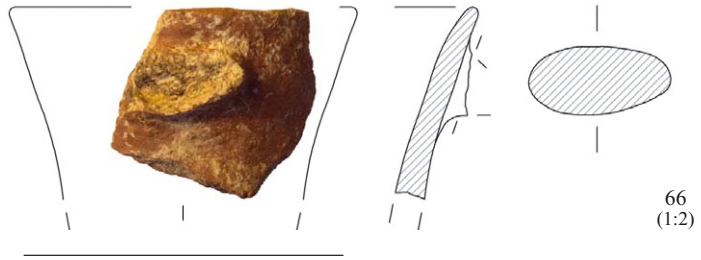

Planierung ÇuHö VIb/VII Grabenverfüllung C: SE 1258 (66); SE 1283 (68); SE 1307 (77, 94, 98, 104)

Tafel 4

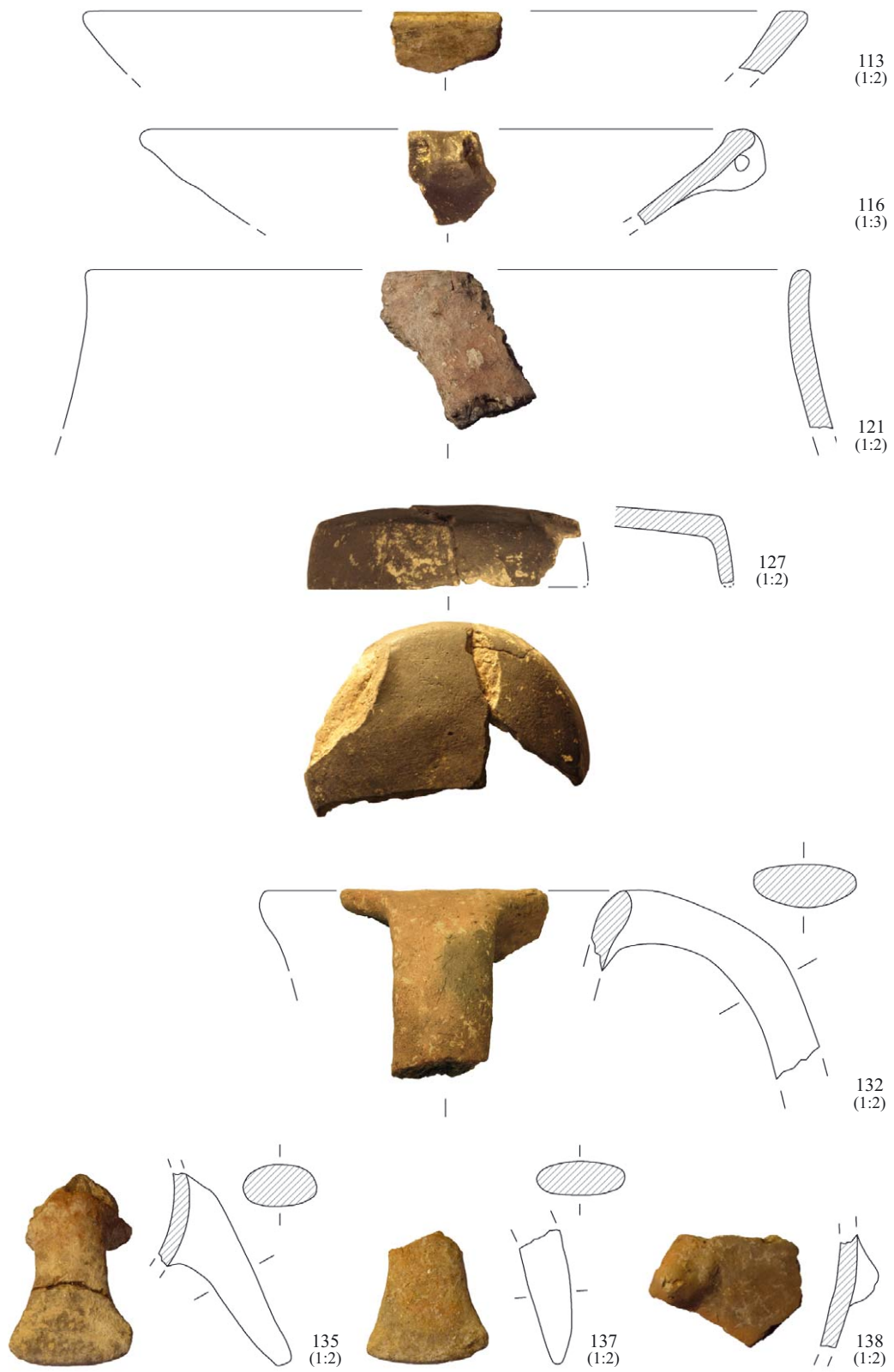

Planierung ÇuHö VIb/VII Grabenverfüllung C: SE 1343 (113, 116, 121, 127, 132, 135, 137–138)

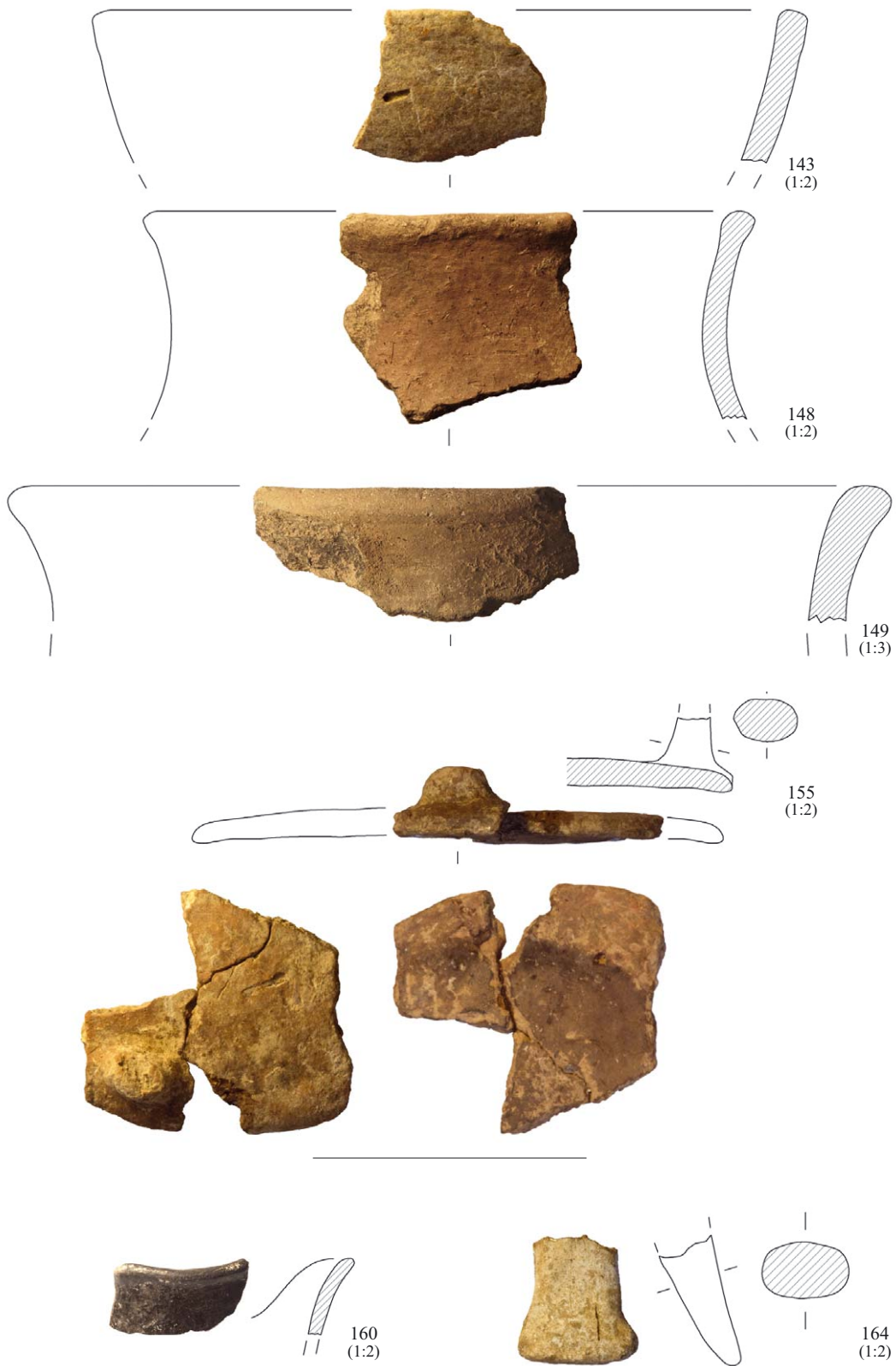

Planierung ÇuHö VIb/VII Grabenverfüllung C: SE 1344 (143, 148-149); SE 1345 (155); SE 1368 (160, 164)

Tafel 6

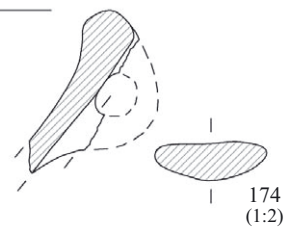
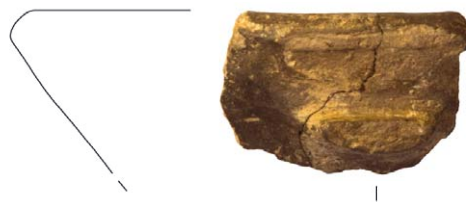
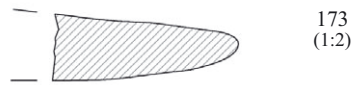
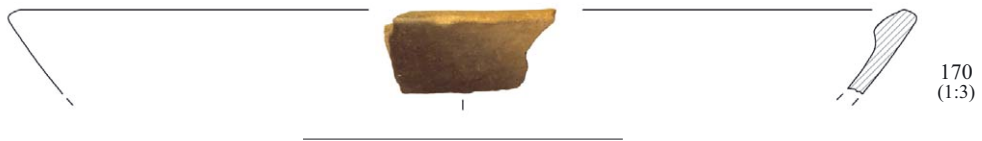

178
(1:2)

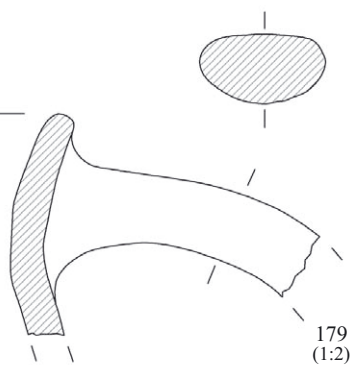

Planierung ÇuHö VIb/VII Grabenverfüllung C: SE 1501 (170); SE 4551 (173-174, 178-179)

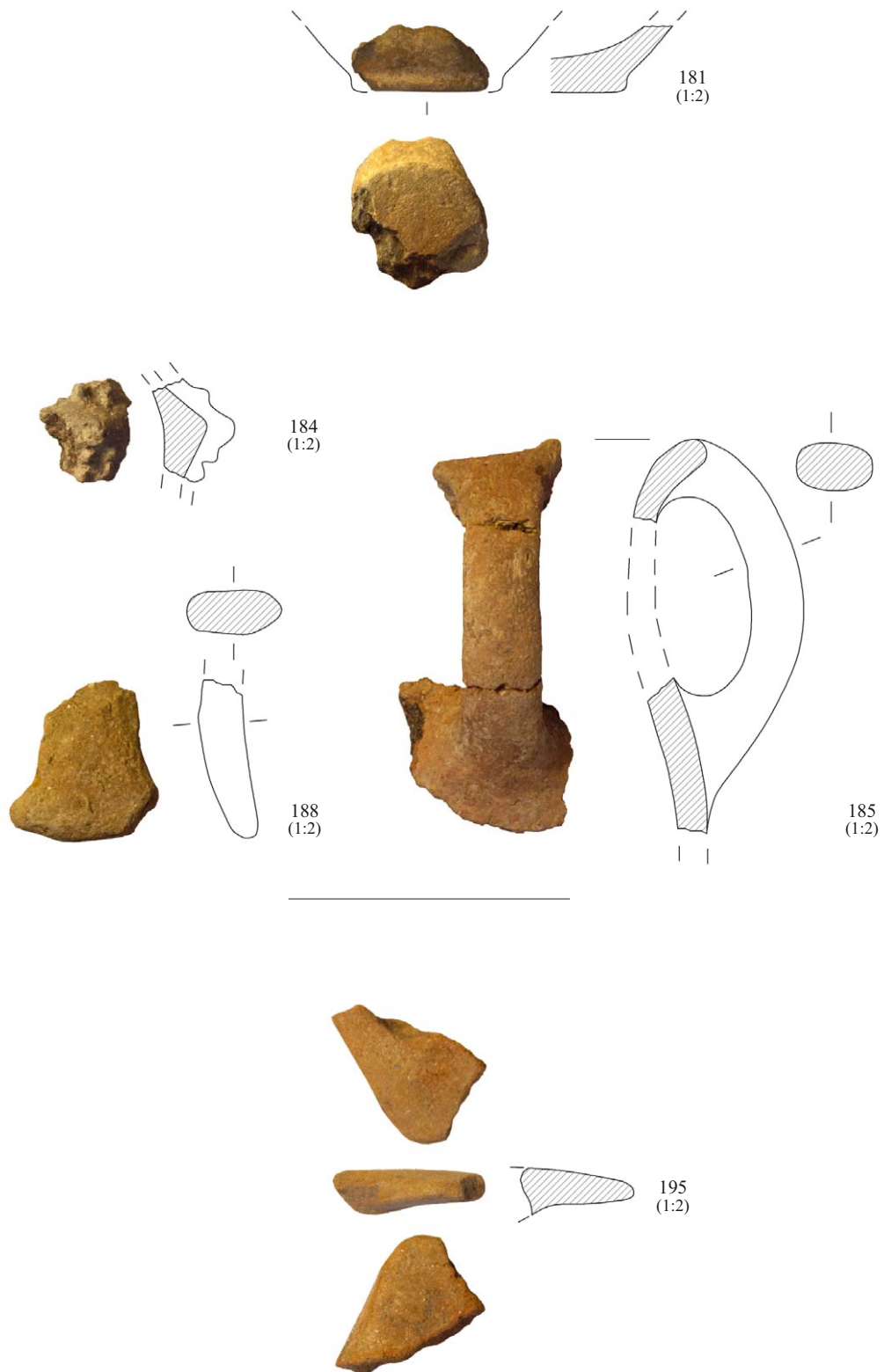

Planierung ÇuHö VIb/VII Grabenverfüllung C: SE 4551 (181, 184–185, 188)
Planierschicht: SE 1449 (195)

Tafel 8



Planierung ÇuHö VIb/VII Planierschicht: SE 1449 (196, 199–200, 202, 204–206)

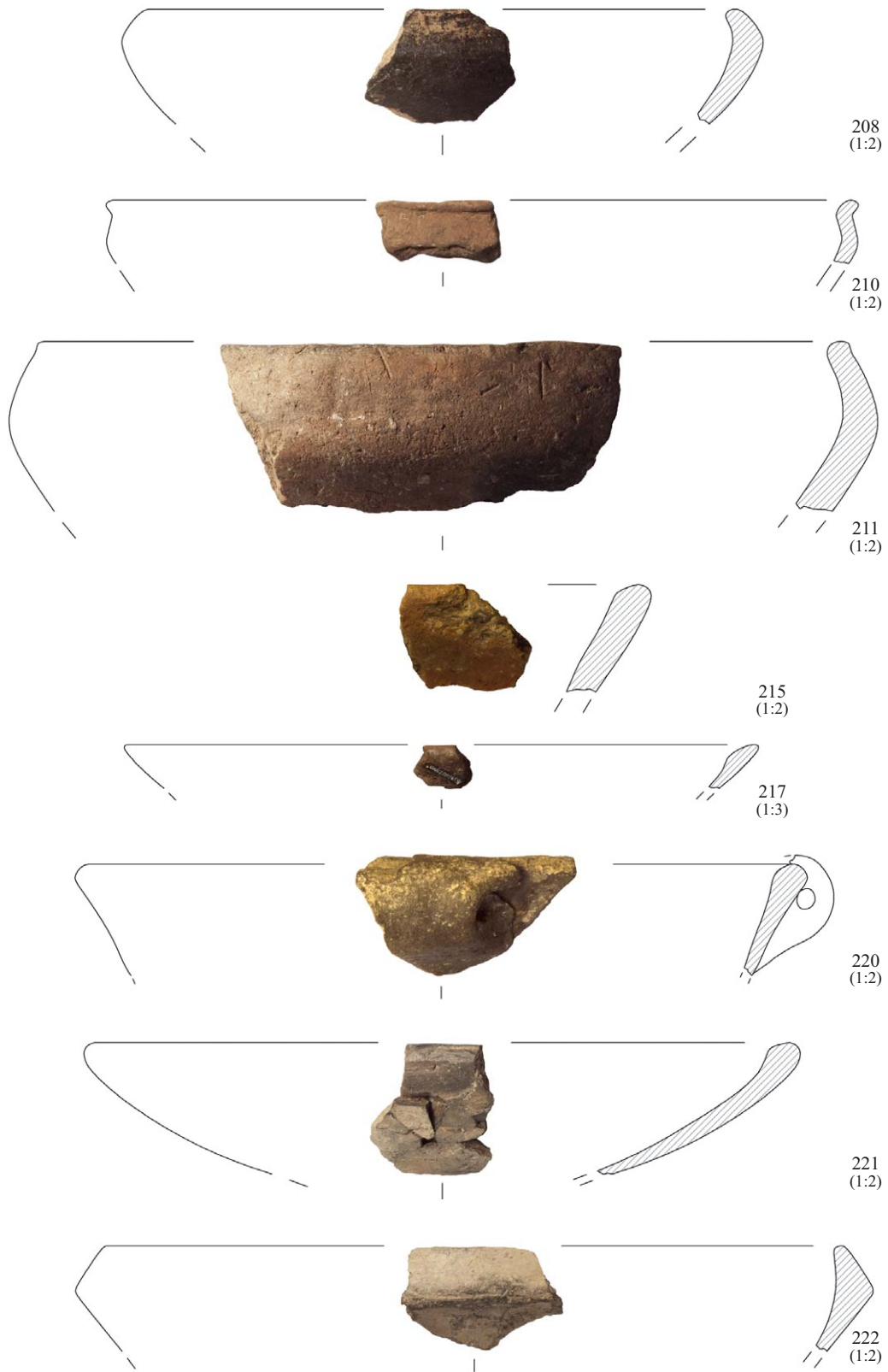

Planierung ÇuHö VIb/VII Planierschicht: SE 1449 (208, 210–211, 215, 217, 220–222)

Tafel 10

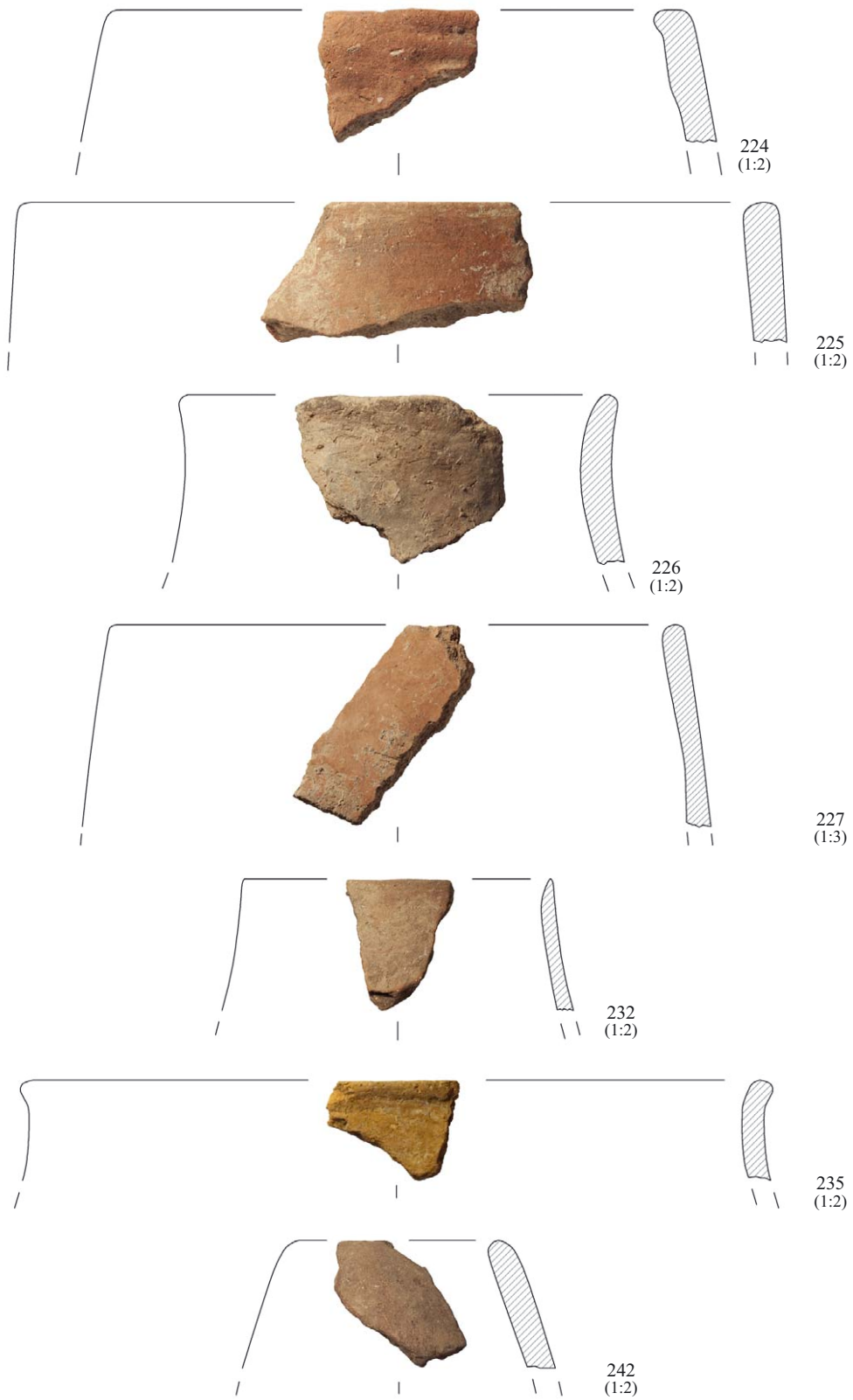

Planierung ÇuHö VIb/VII Planierschicht: SE 1449 (224–227, 232, 235, 242)

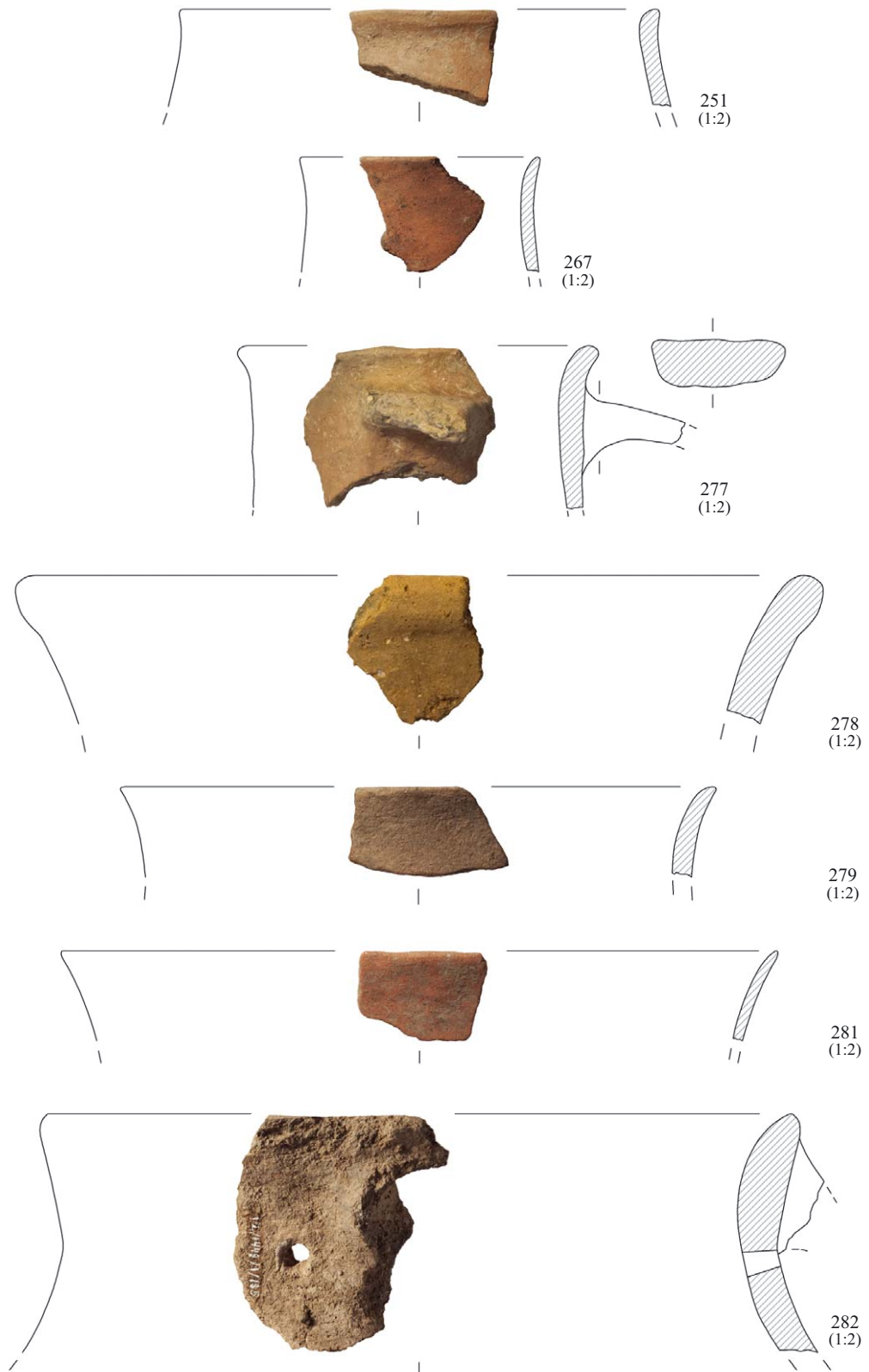

Planierung ÇuHö VIb/VII Planierschicht: SE 1449 (251, 267, 277-279, 281-282)

Tafel 12

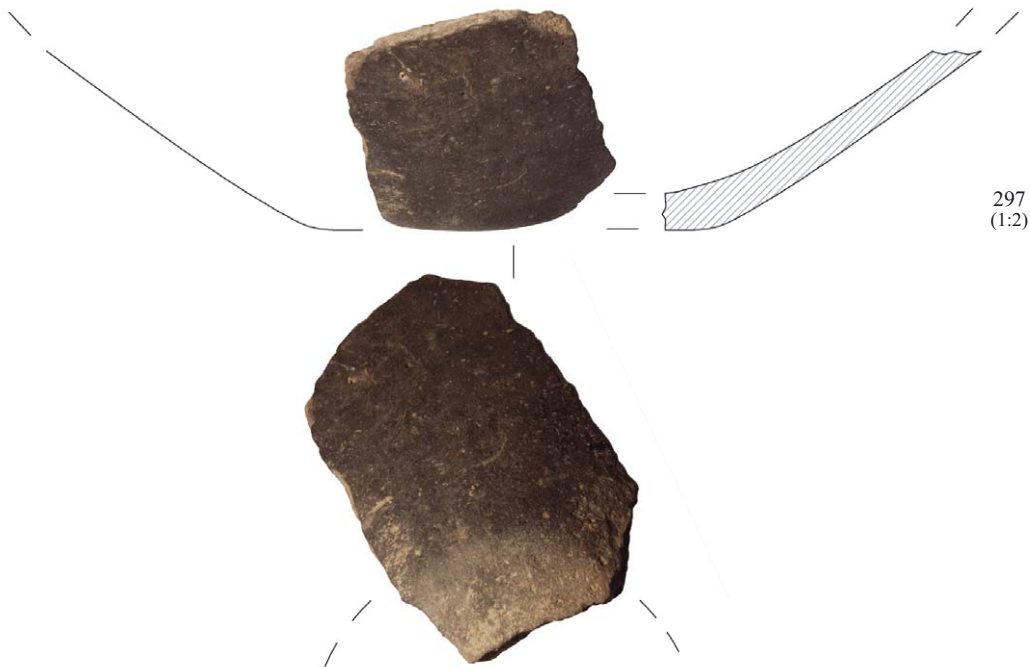
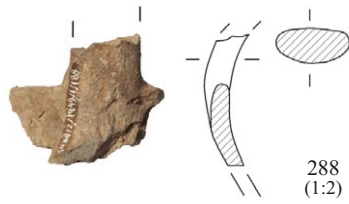

Planierung ÇuHö VIb/VII Planierschicht: SE 1449 (283–284, 288, 297)

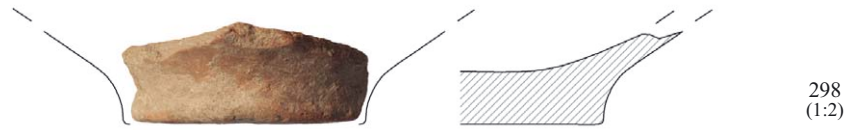

298
(1:2)



307
(1:2)

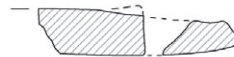

321
(1:2)

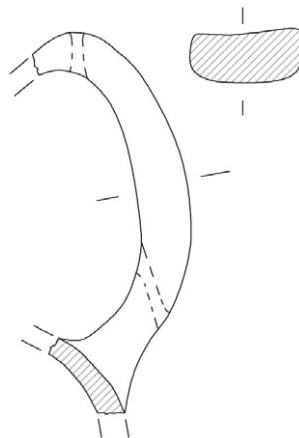

325
(1:2)

Tafel 14

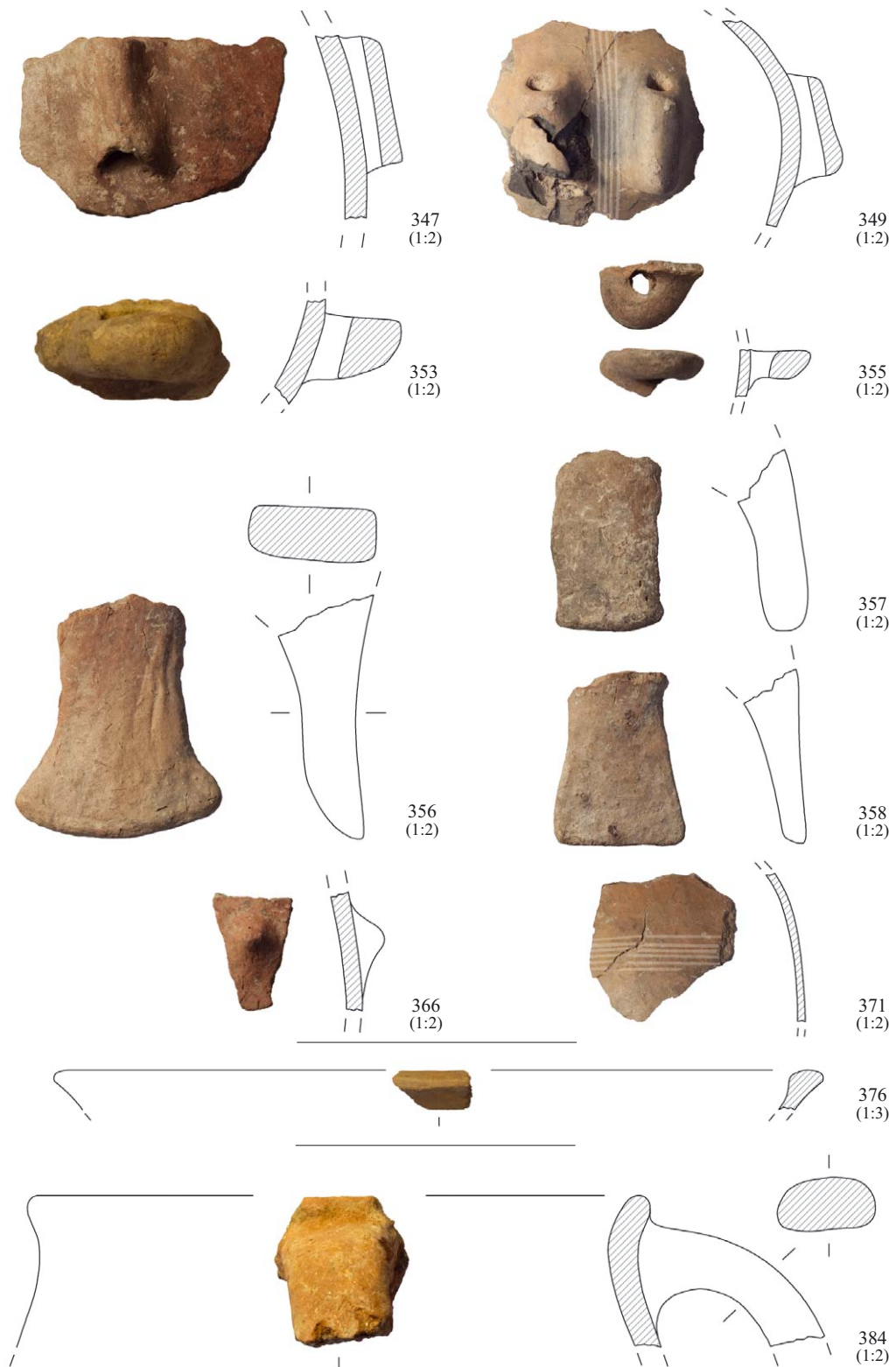

Planierung ÇuHö VIb/VII Planierschicht: SE 1449 (347, 349, 353, 355–358, 366, 371);
SE 4503 (376); SE 4511 (384)

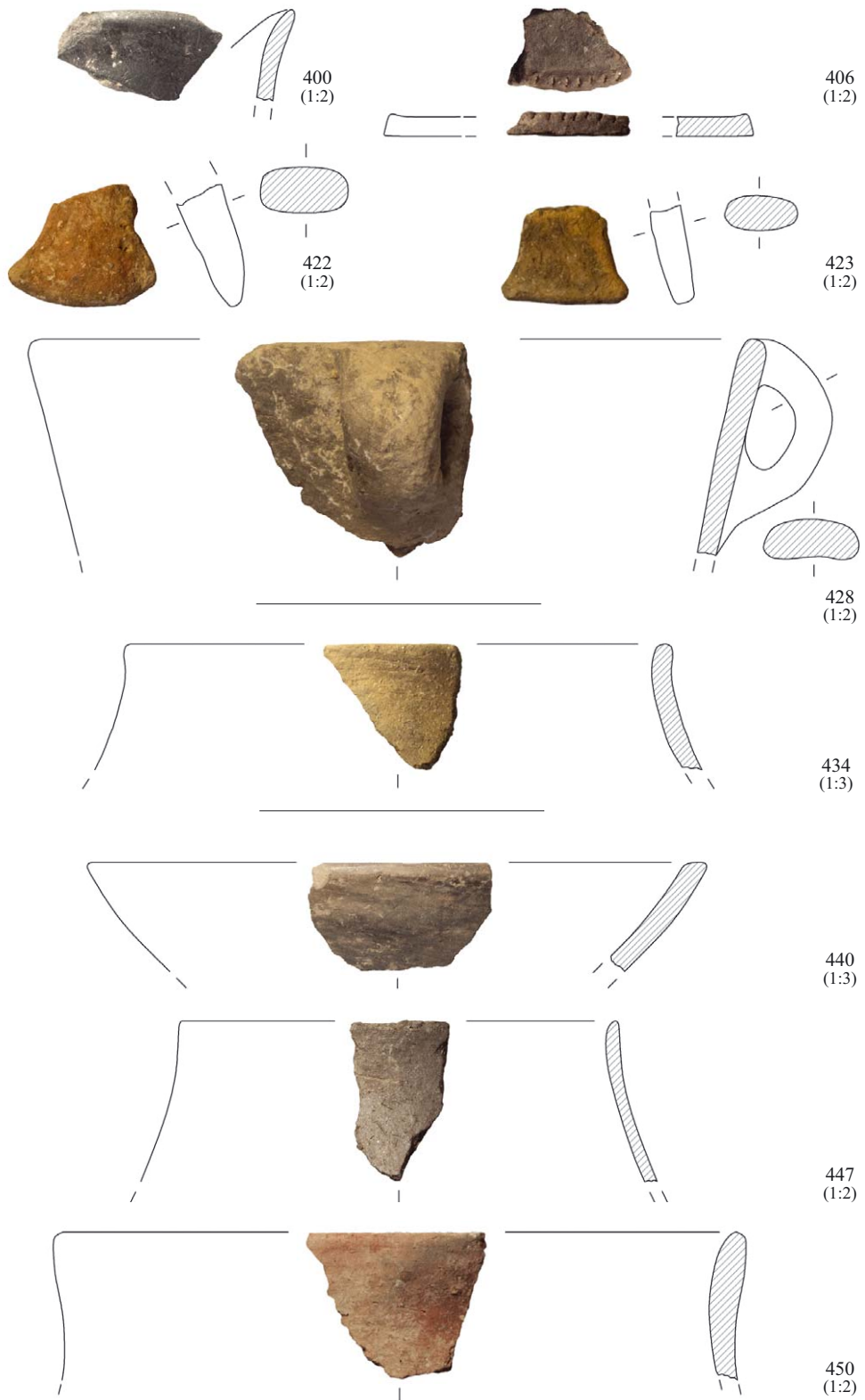

Planierung ÇuHö VIb/VII Planierschicht: SE 4511 (400, 406, 422–423, 428); Steinkistenkomplex: SE 4509 (434)
 ÇuHö VIb SE 1448 (440, 447, 450)

Tafel 16

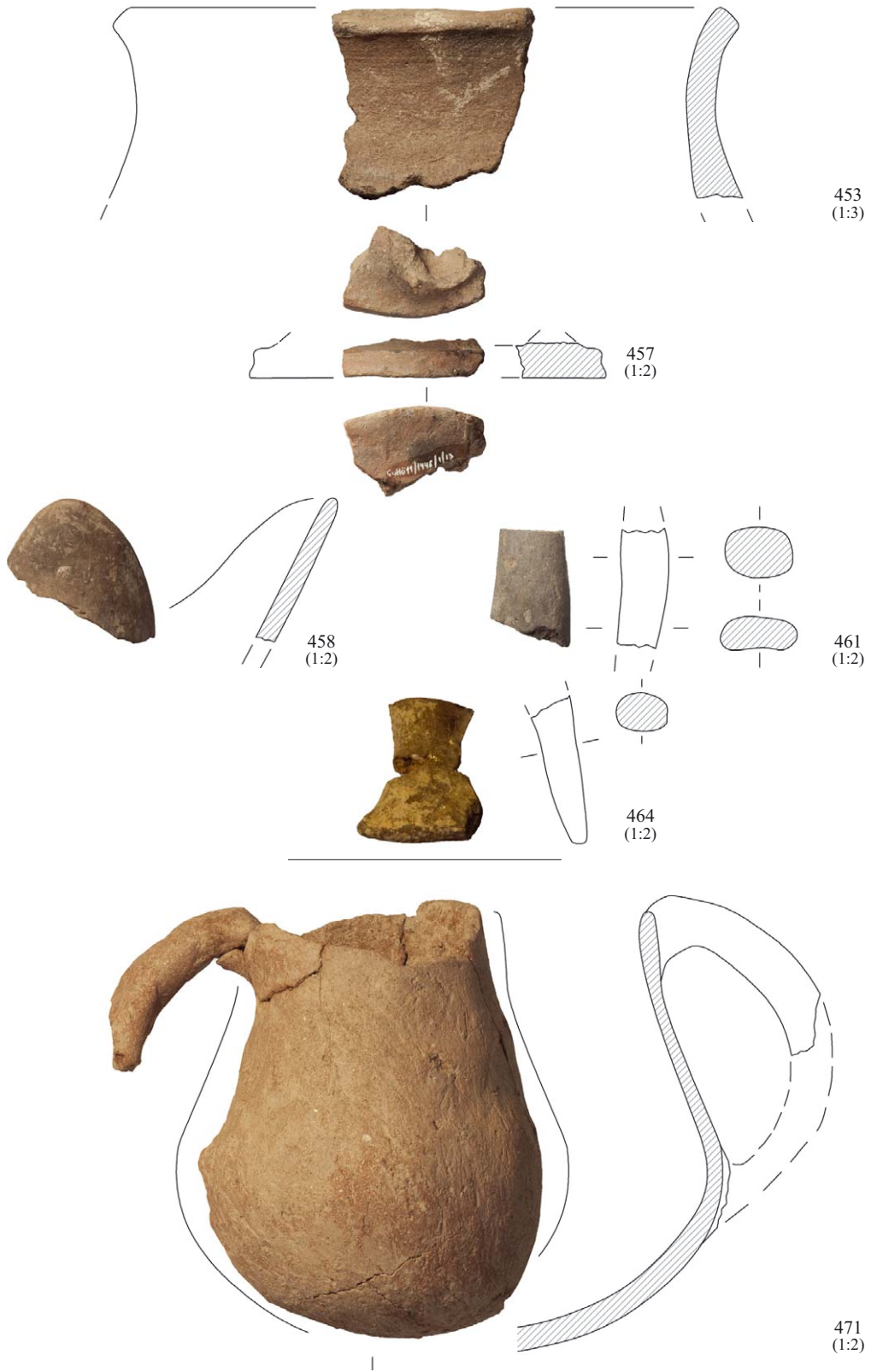

ÇuHö VIb SE 1448 (453, 457-458, 461, 464); SE 1451 (471)

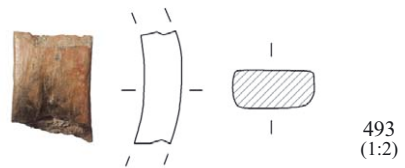
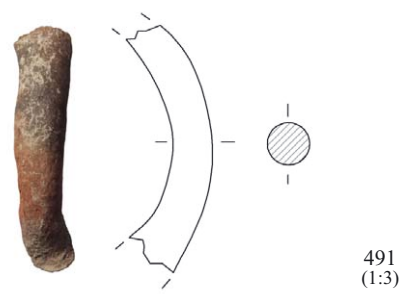
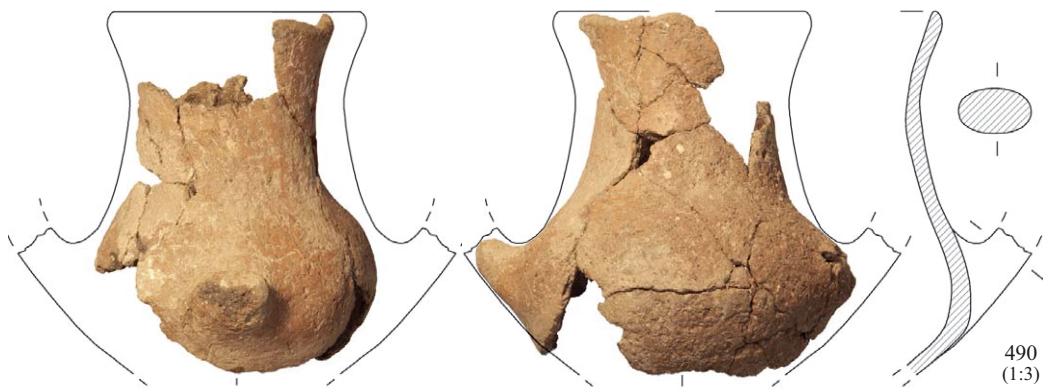
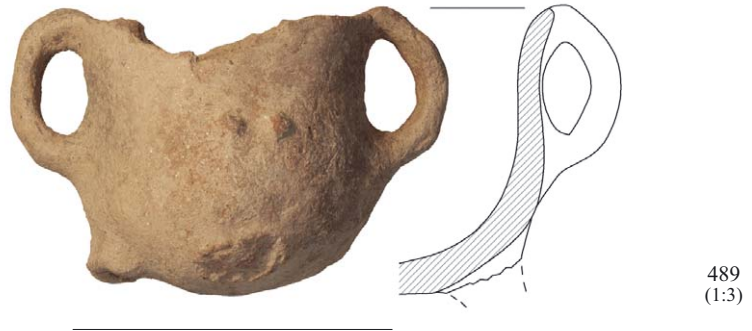

Tafel 18

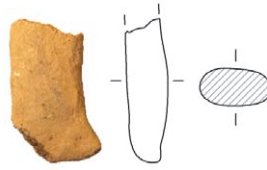

501
(1:3)



502
(1:4)

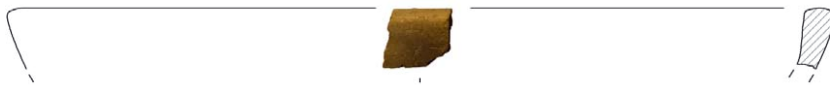

504
(1:4)

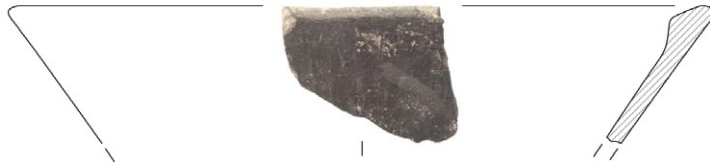

505
(1:3)



507
(1:3)



522
(1:3)

ÇuHö VIb SE 5350 (501)

Planierung ÇuHö VIa/VIb SE 1445 (502, 504–505, 507); SE 1457 (522)

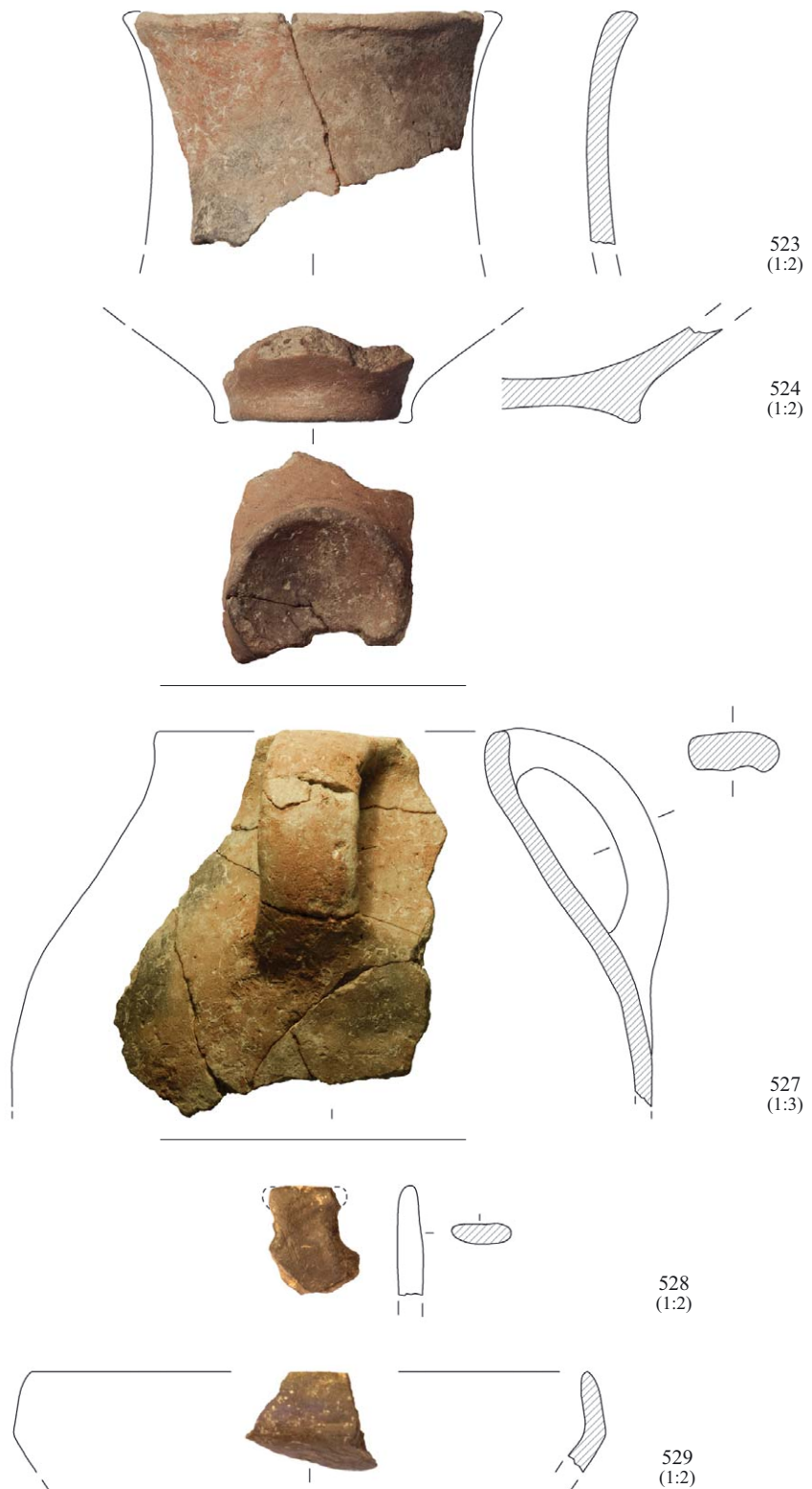

Planierung ÇuHö VIa/VIb SE 1457 (523–524); SE 1462 (527); SE 5591 (528–529)

Tafel 20

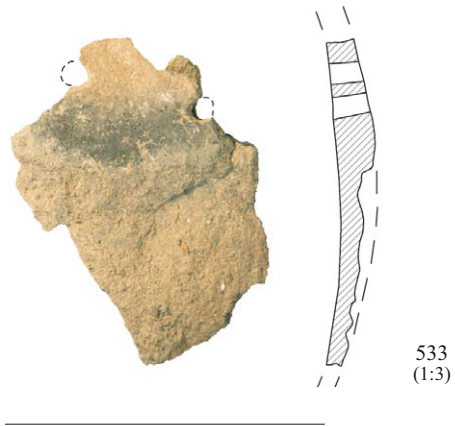

ÇuHö VIa SE 5445 (533); SE 5446 (535); SE 5468 (537-538)

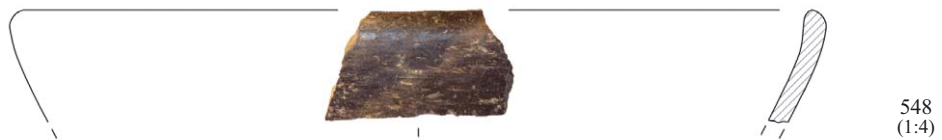
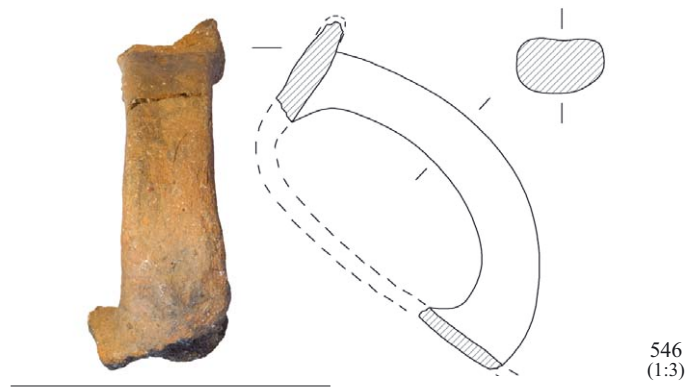
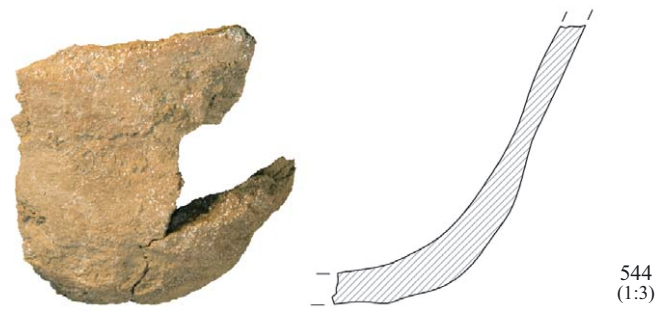
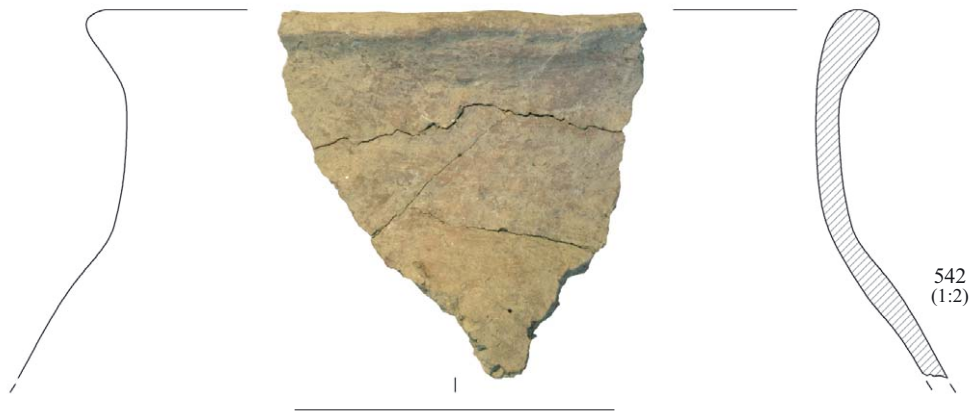

ÇuHö VIa SE 5514 (542); SE 5585 (544, 546); SE 5590 (547–548)

Tafel 22

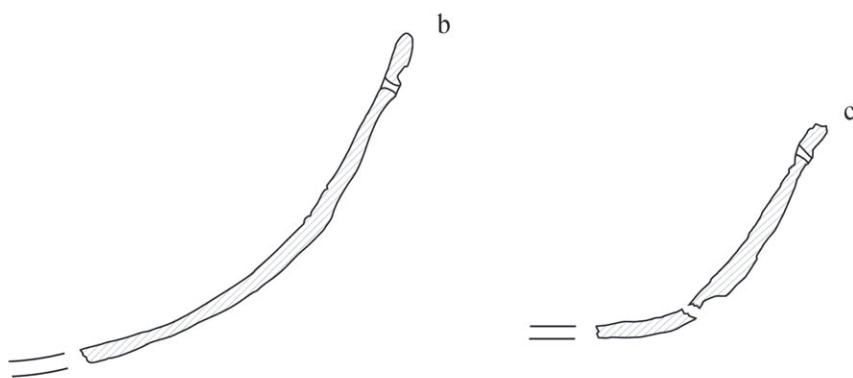
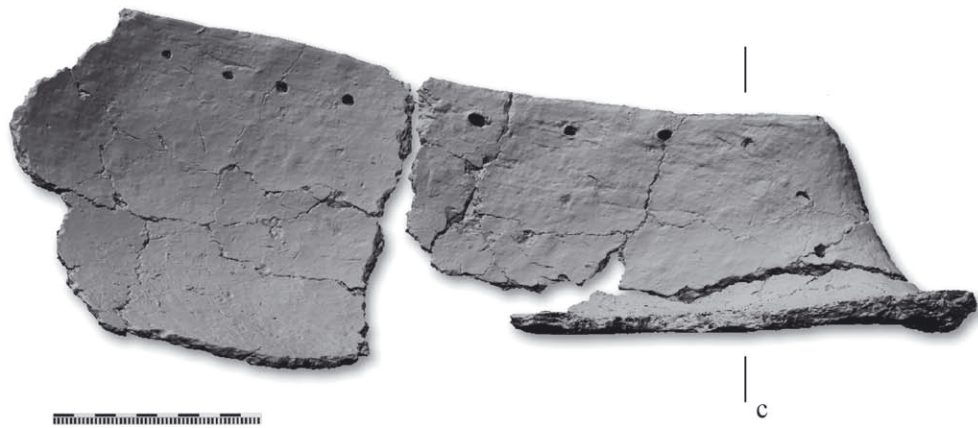
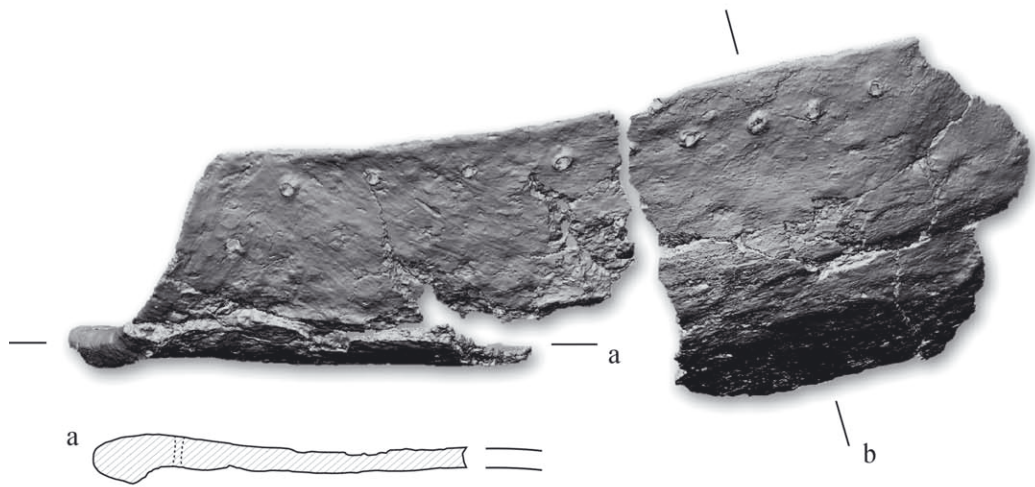

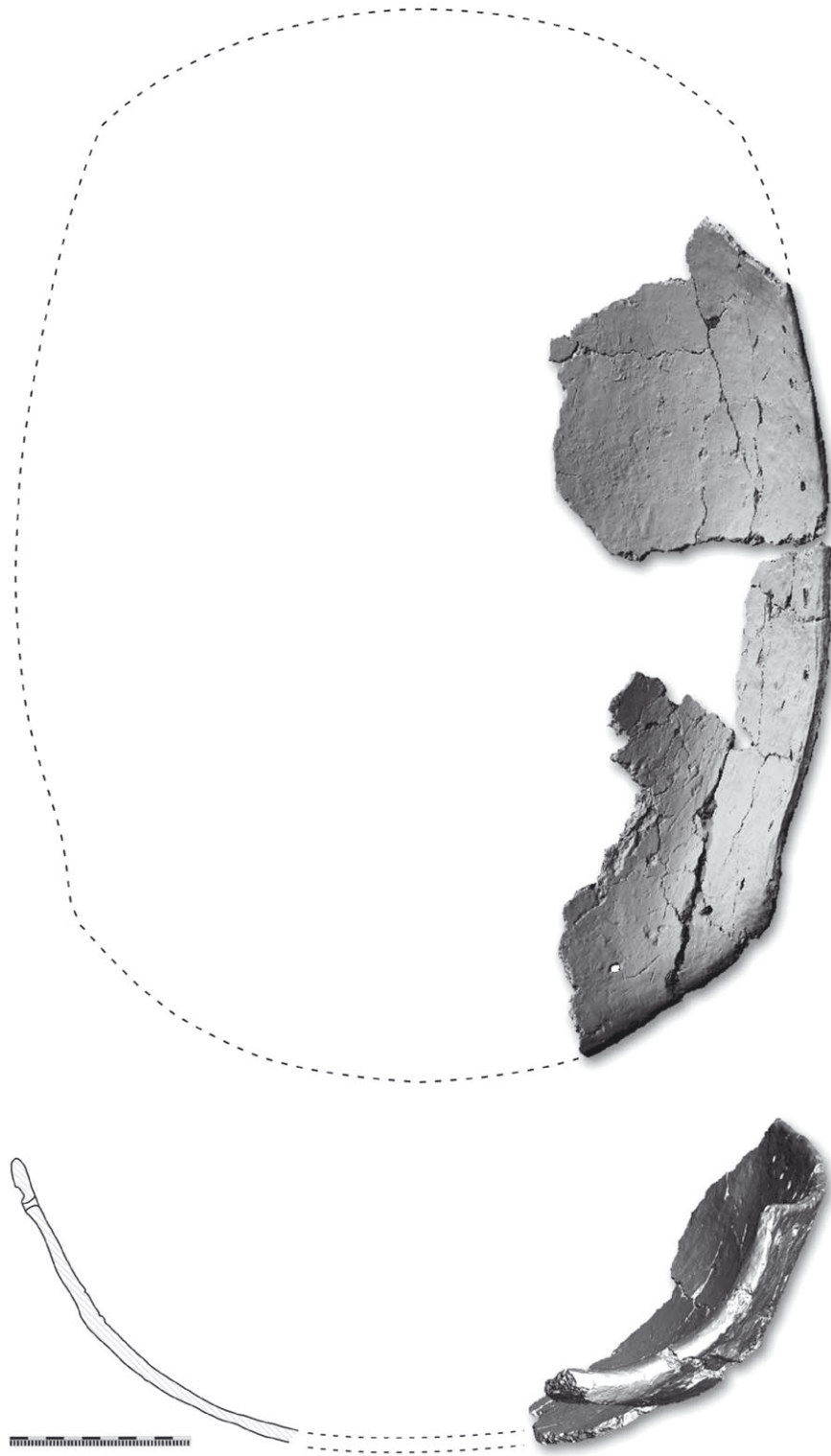

ÇuHö VIa SE 5514 (543)

Tafel 24

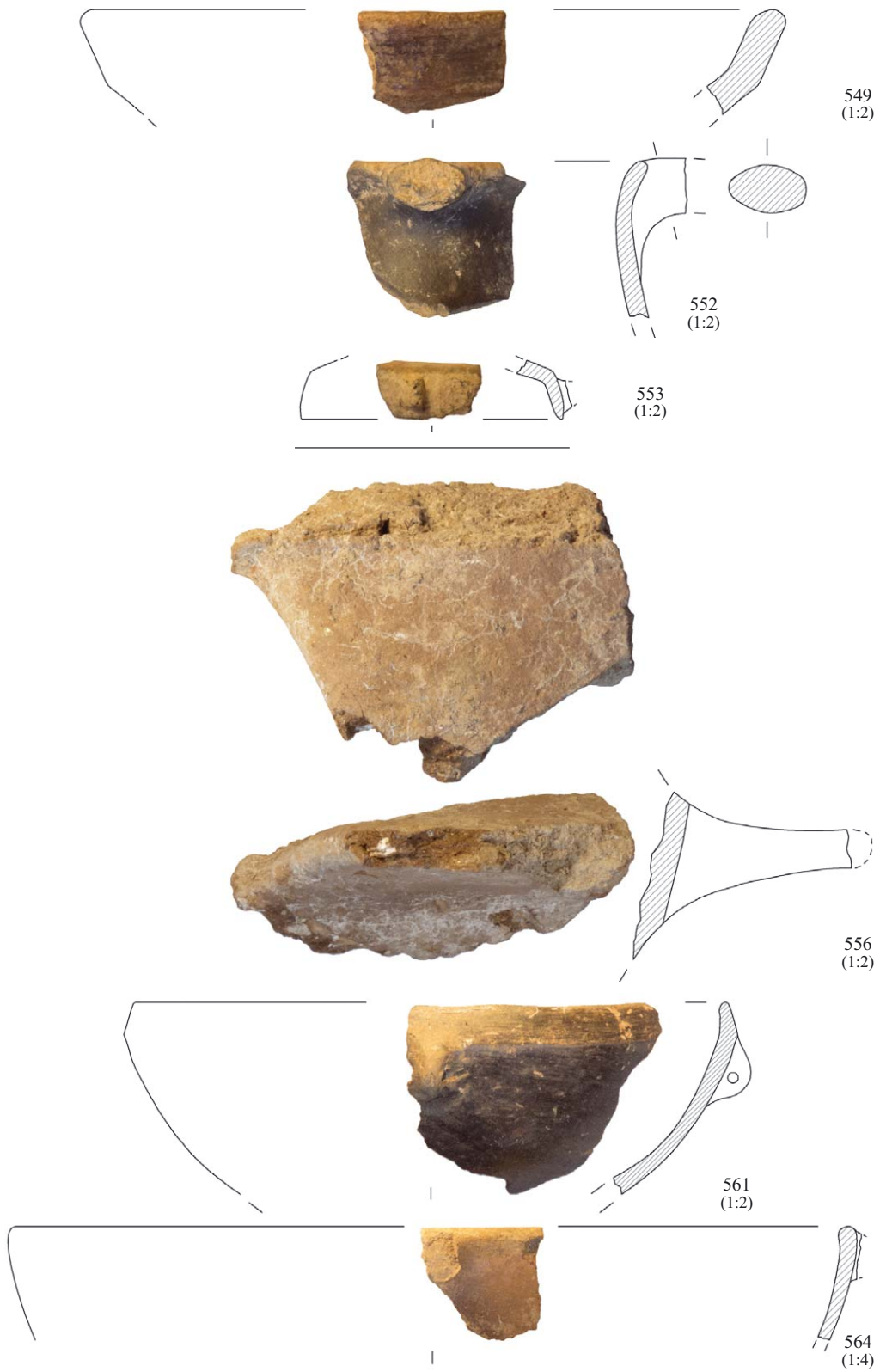

ÇuHö VIa SE 5590 (549, 552–553)
Planierung ÇuHö Vb/VIa SE 5465 (556, 561, 564)

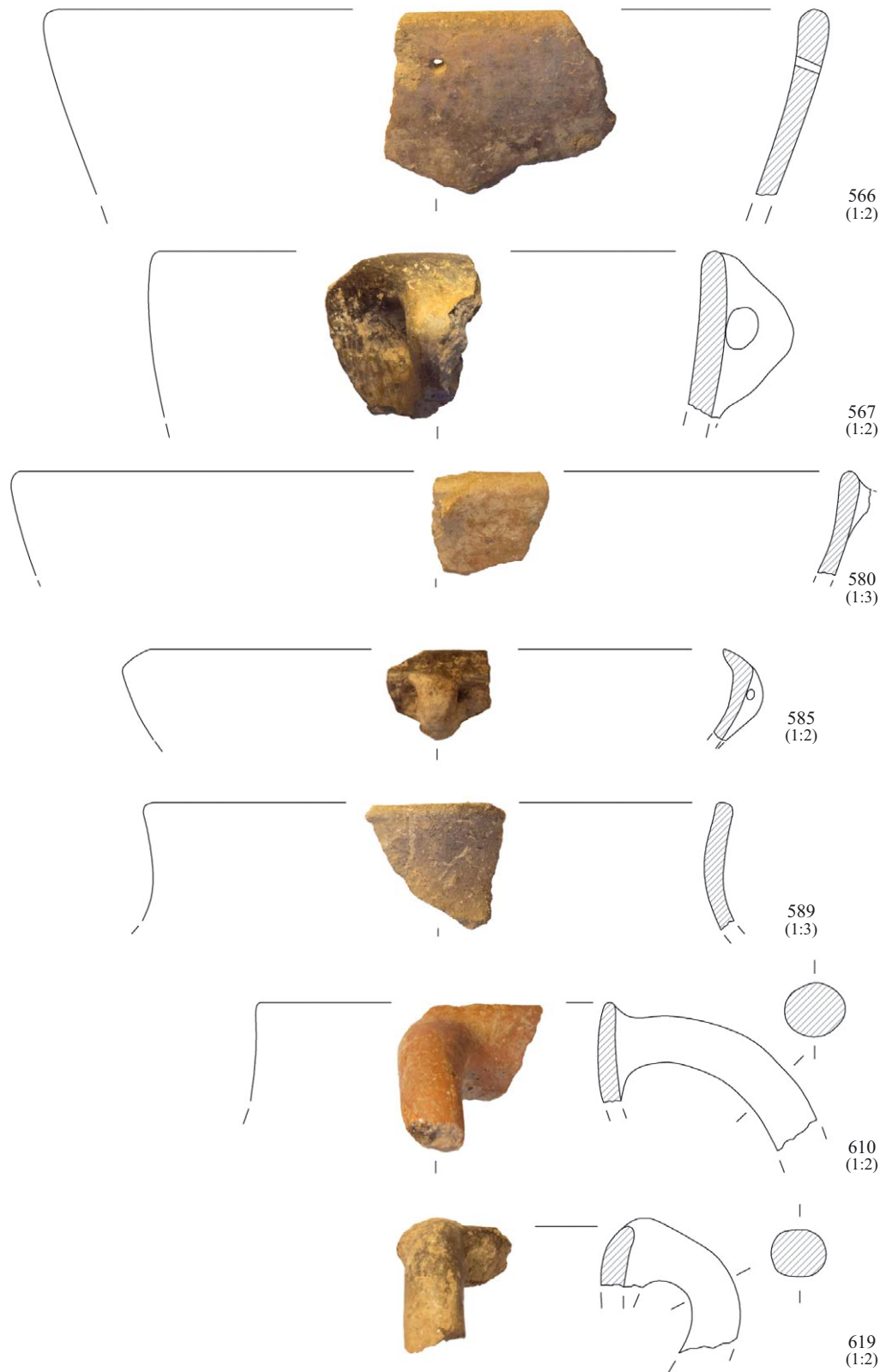

Planierung ÇuHö Vb/VIa SE 5465 (566-567, 580, 585, 589, 610, 619)

Tafel 26

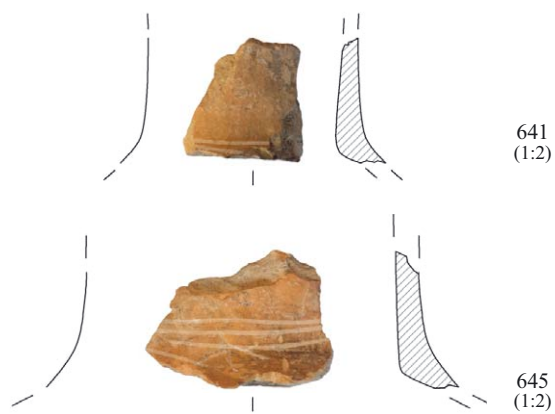
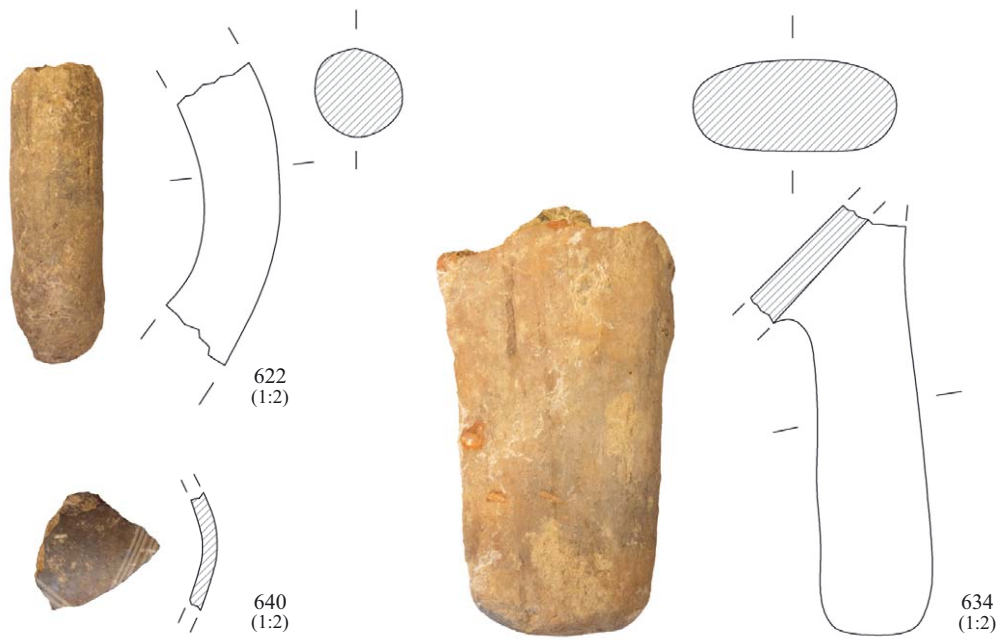

Planierung ÇuHö Vb/VIa SE 5465 (622, 634, 640–641, 645); SE 5539 (649, 661)

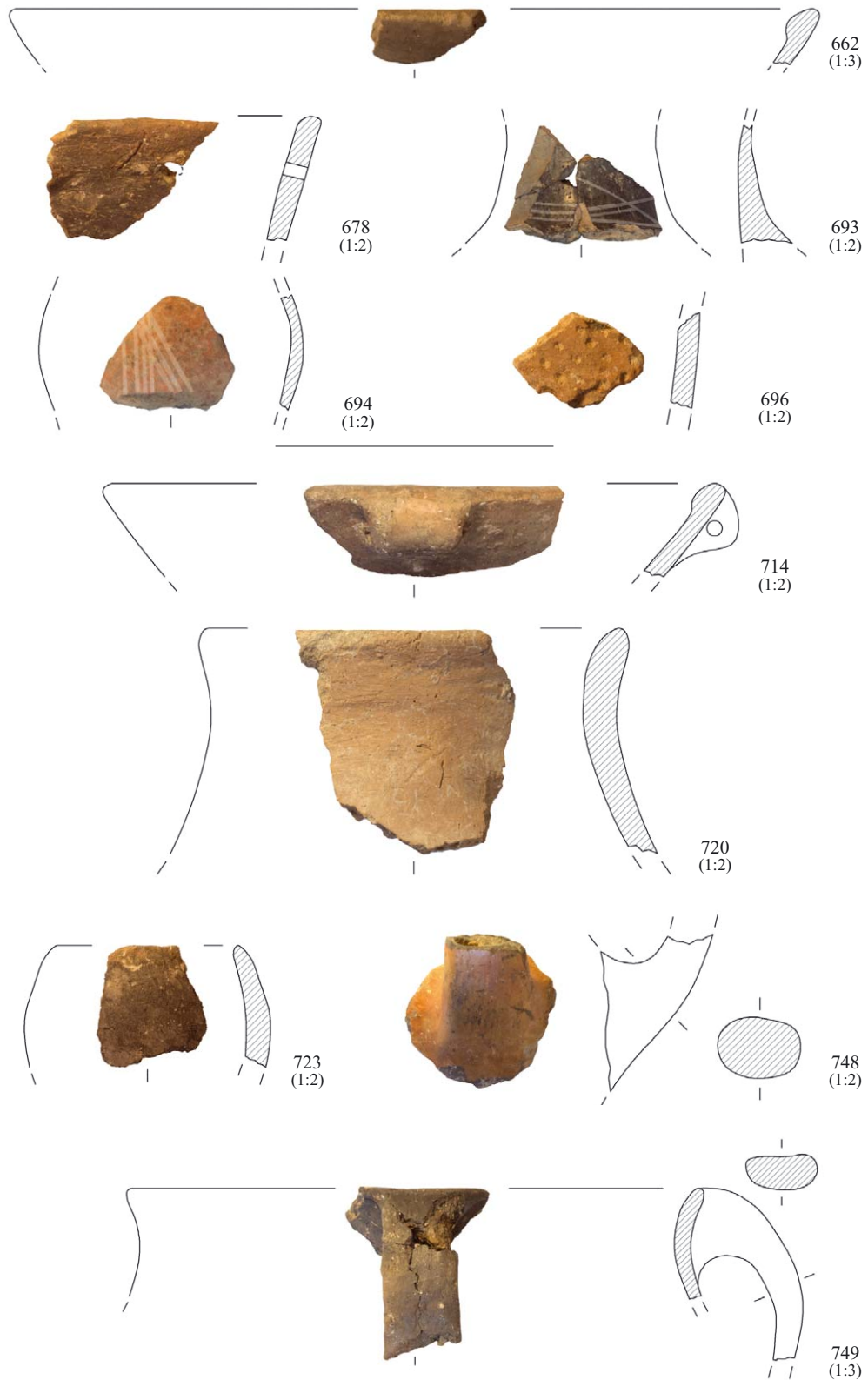

Planierung ÇuHö Vb/V1a SE 5539 (662, 678, 693–694, 696); SE 5543 (714, 720, 723, 748–749)

Tafel 28

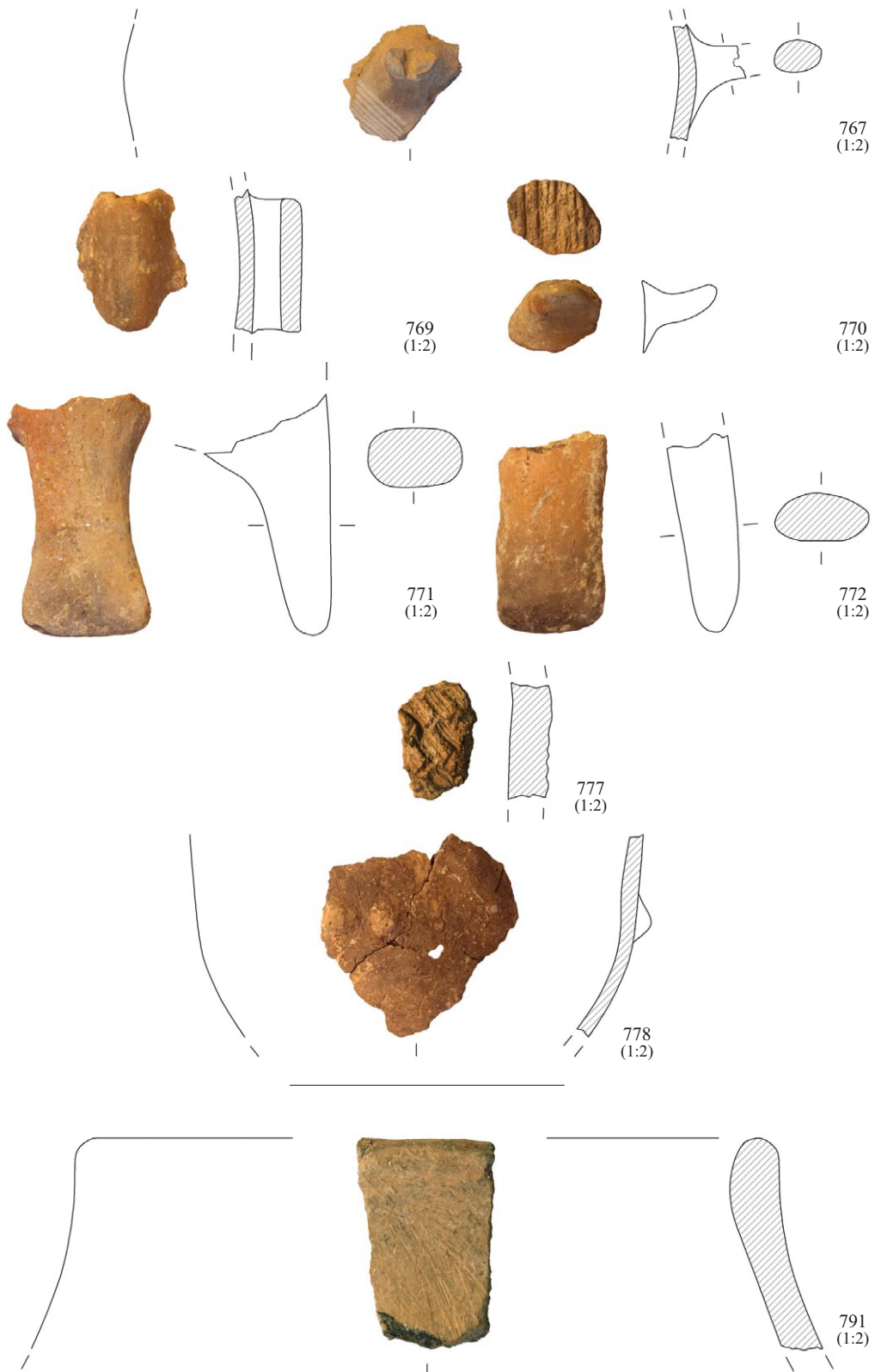

Planierung ÇuHö Vb/VIa SE 5543 (767, 769-772, 777-778)

Planierung ÇuHö IV/VIa SE 5422 (791)

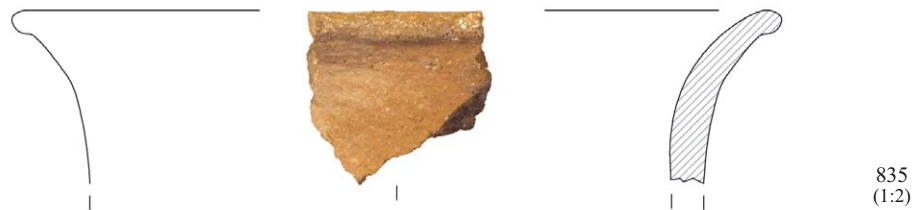
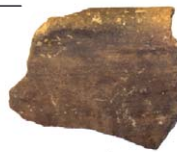
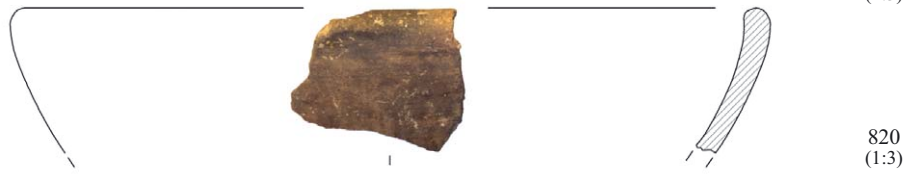

Planierung ÇuHö IV/V1a SE 5422 (798)
ÇuHö Vb SE 5325 (812, 816, 820, 825, 833, 835)

Tafel 30

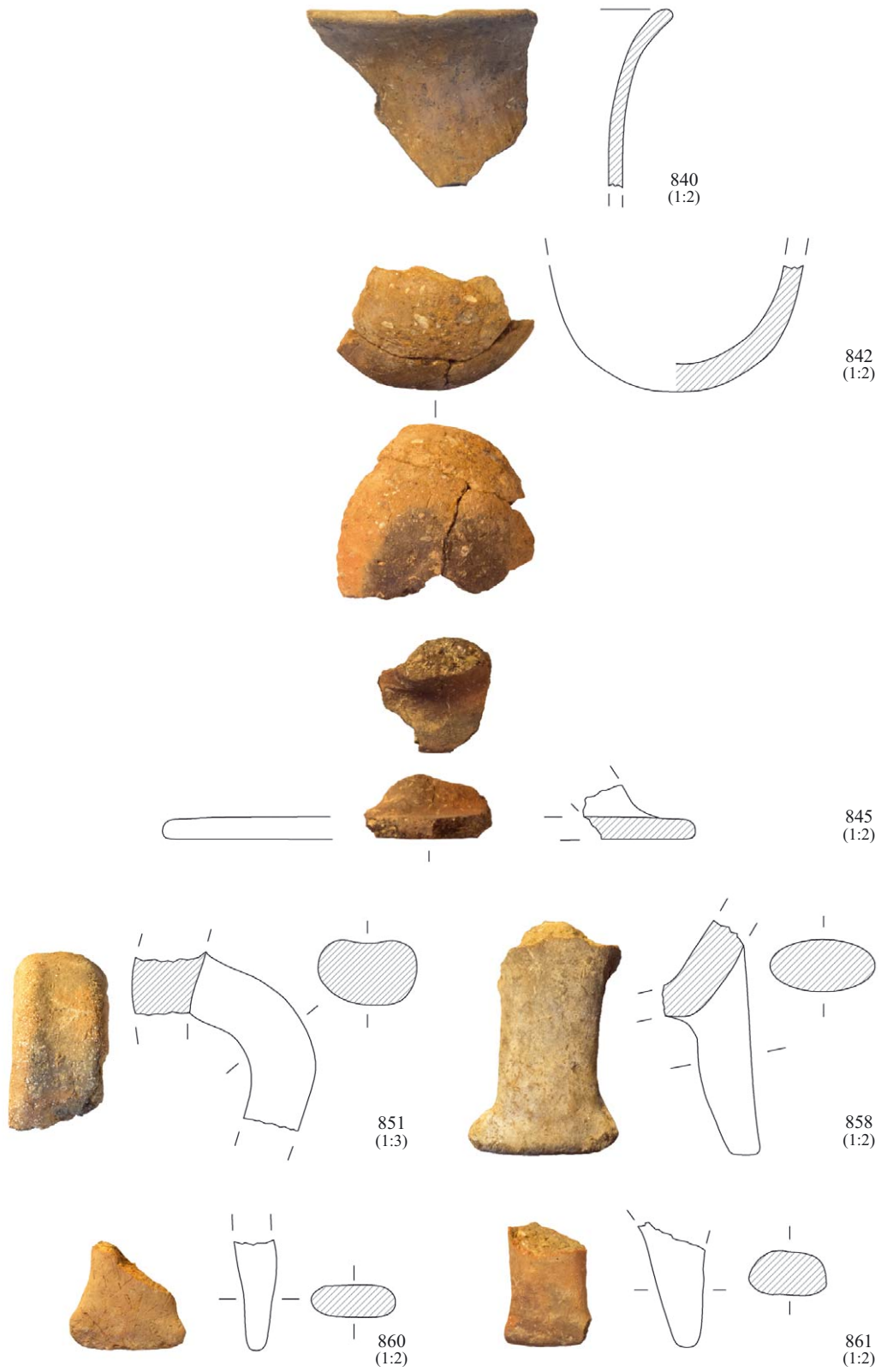

ÇuHö Vb SE 5325 (840, 842, 845, 851, 858, 860-861)

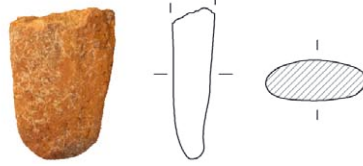

868
(1:3)



869
(1:2)

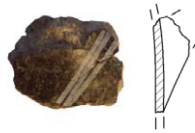

873
(1:2)



874
(1:2)

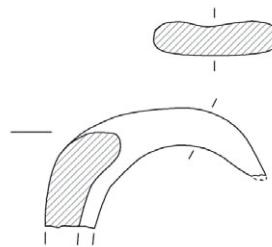

875
(1:3)

ÇuHö Vb SE 5326 (868); SE 5329 (869, 873); SE 5476 (874); SE 5490 (875)

Tafel 32

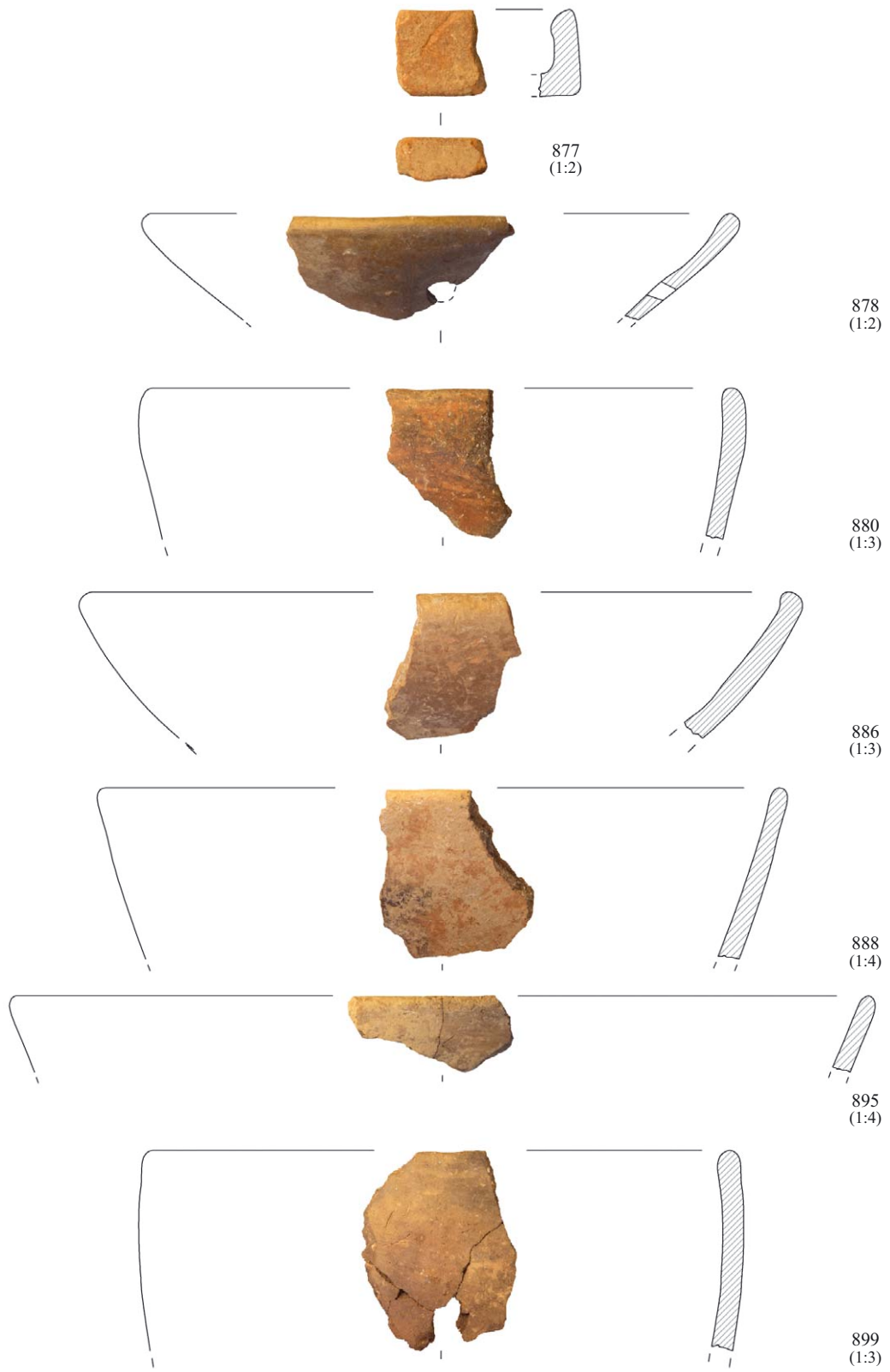

ÇuHö Vb SE 5490 (877-878, 880, 886, 888, 895, 899)

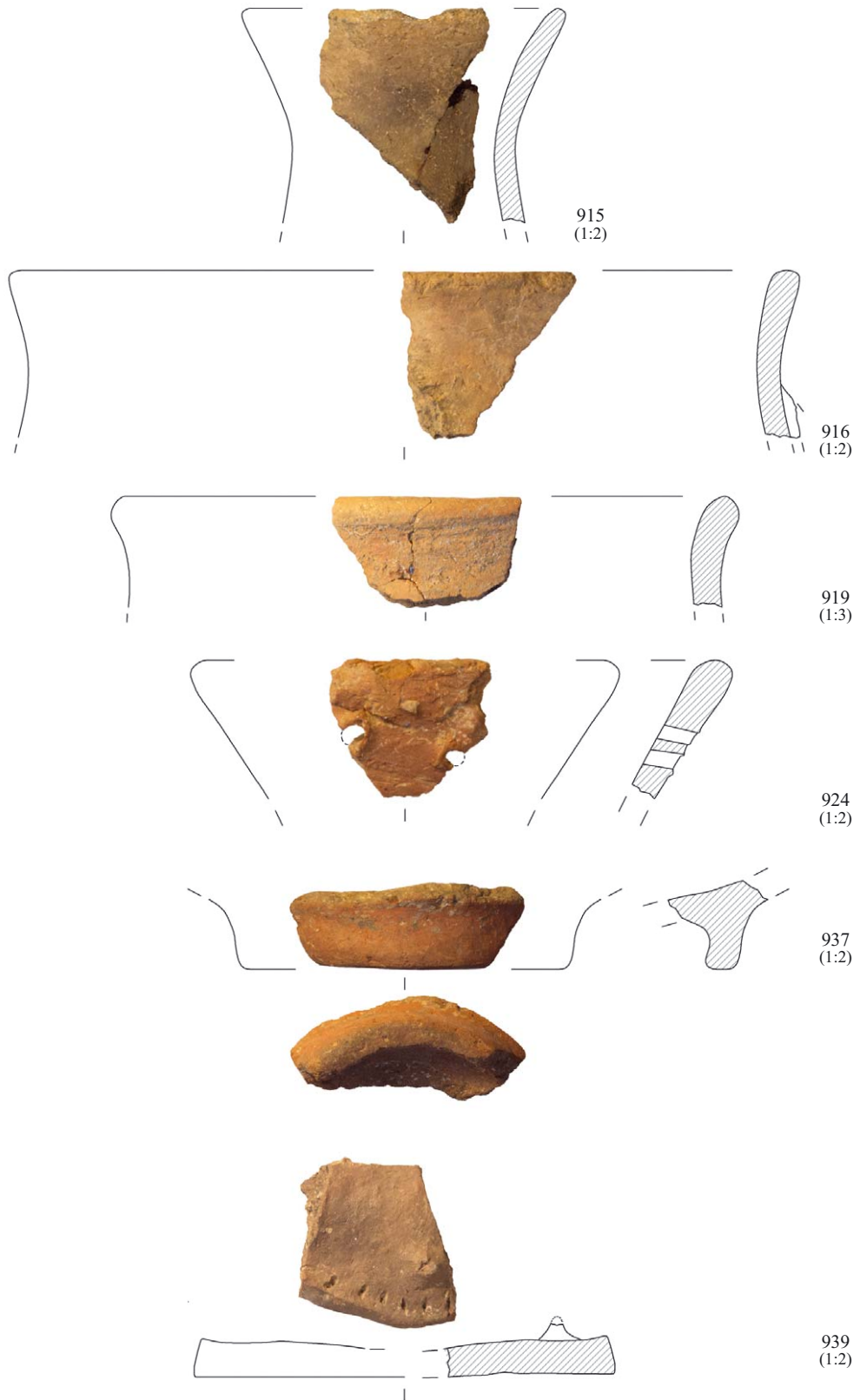

ÇuHö Vb SE 5490 (915–916, 919, 924, 937, 939)

Tafel 34

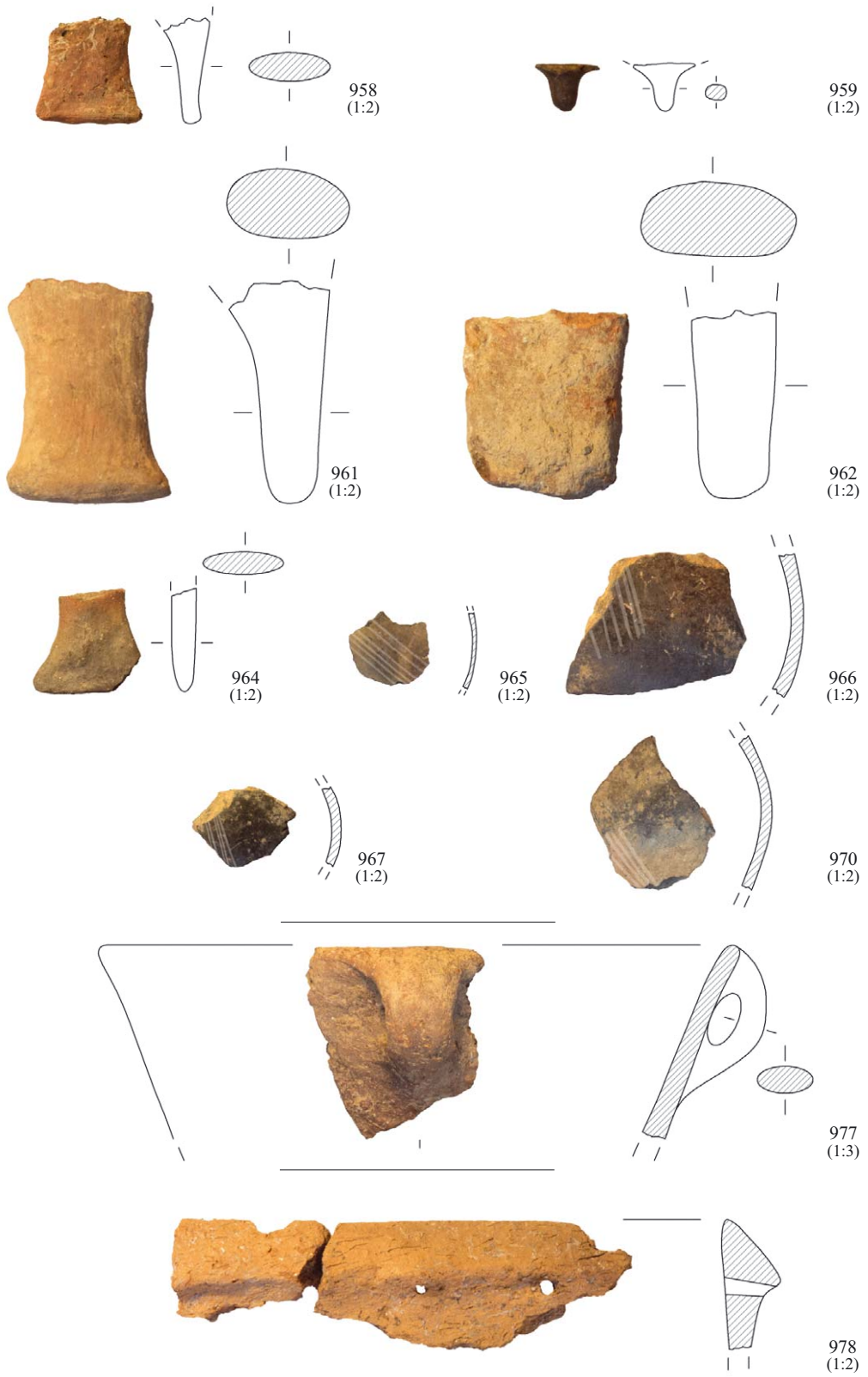

ÇuHö Vb SE 5490 (958–959, 961–962, 964–967, 970); SE 5538 (977); SE 5573 (978)

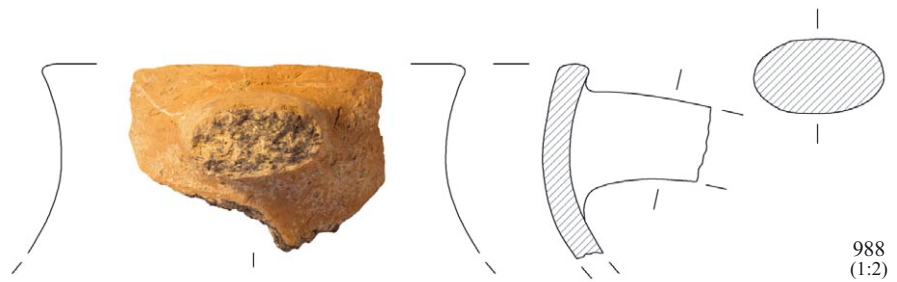
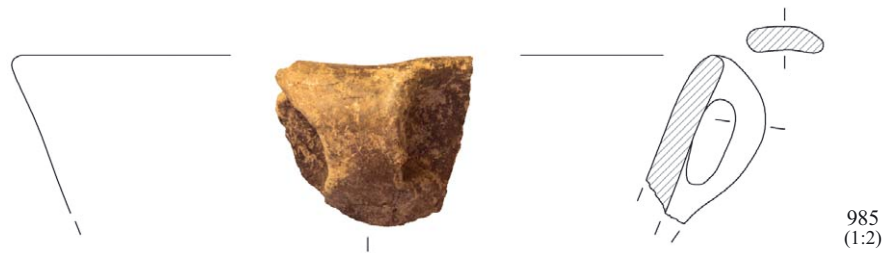
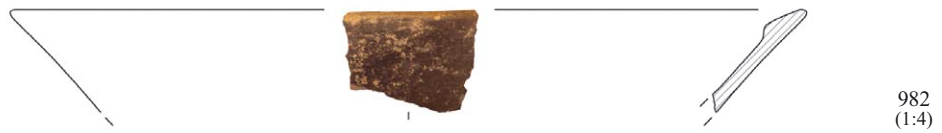

ÇuHö Vb SE 5573 (979); SE 5605 (980)
Planierung ÇuHö Va/Vb SE 5477 (982-985, 988)

Tafel 36

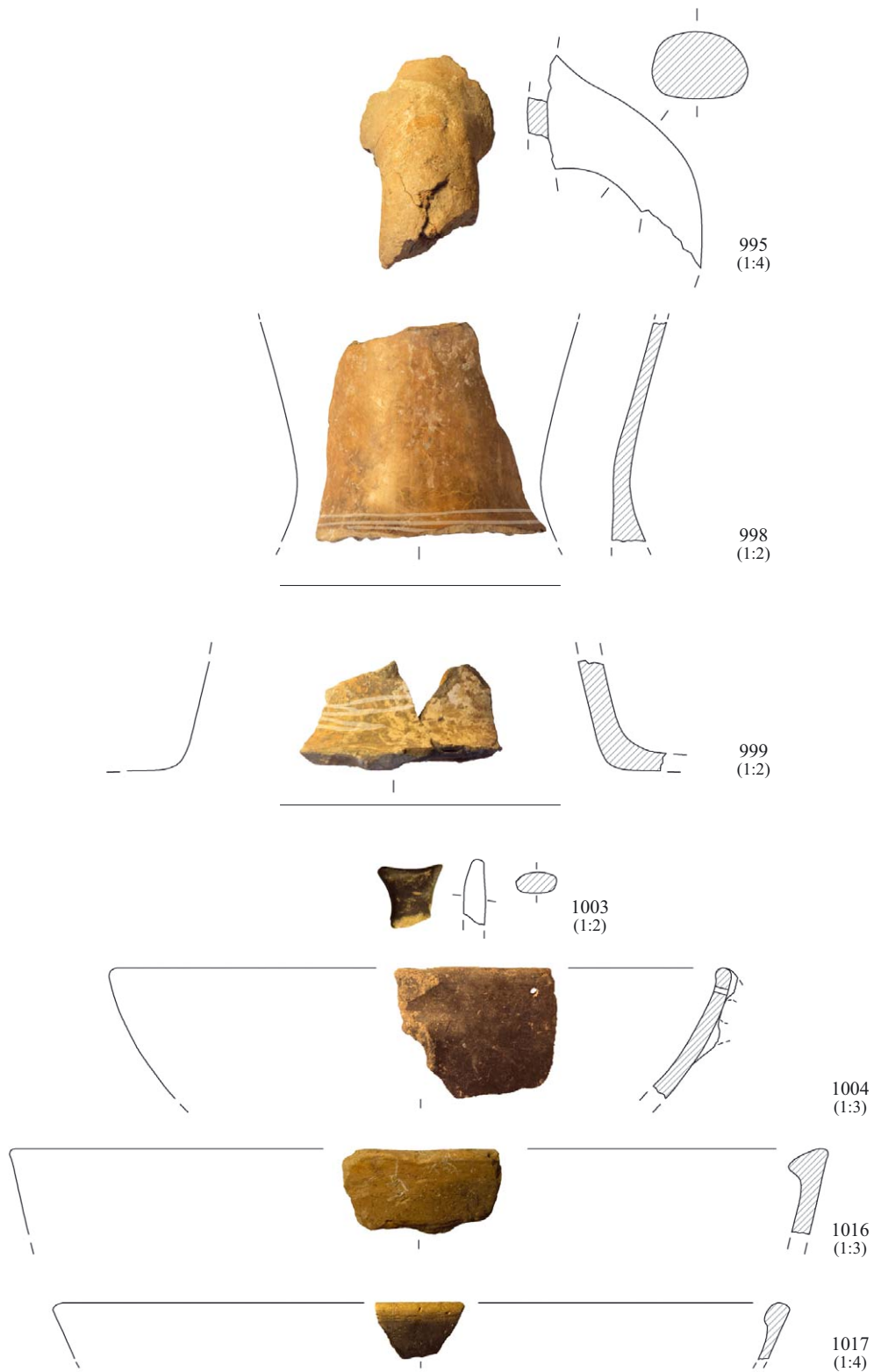

Planierung ÇuHö Va/Vb SE 5477 (995, 998); SE 5489 (999)
 Planierung ÇuHö IV/Vb SE 5302 (1003–1004, 1016–1017)

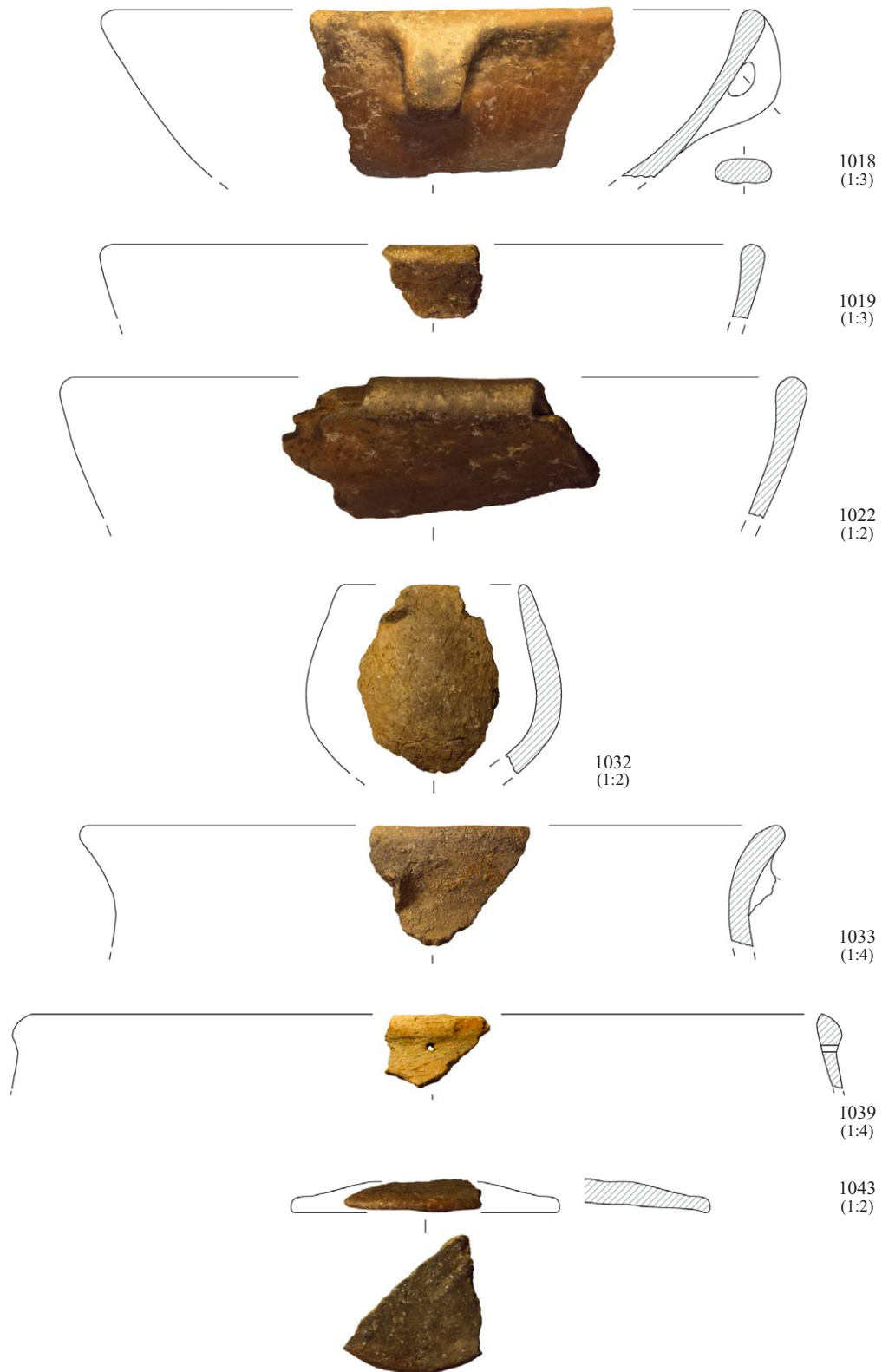

Planierung ÇuHö IV/Vb SE 5302 (1018–1019, 1022, 1032–1033, 1039, 1043)

Tafel 38



Planierung ÇuHö IV/Vb SE 5302 (1073–1074, 1084–1086); SE 5454 (1094–1095); SE 5467 (1096, 1098)

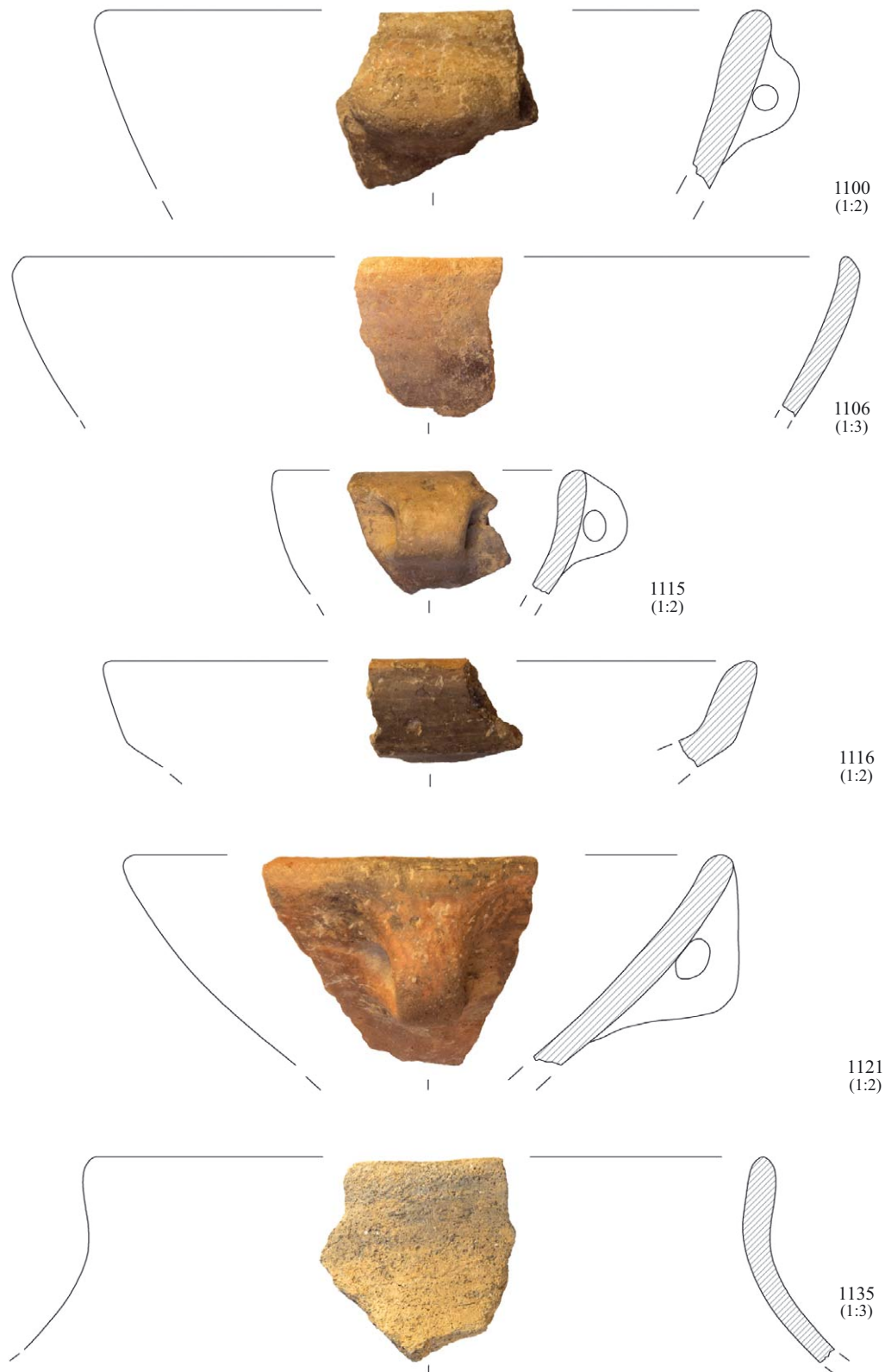

Planierung ÇuHö IV/Vb SE 5467 (1100, 1106, 1115–1116, 1121, 1135)

Tafel 40

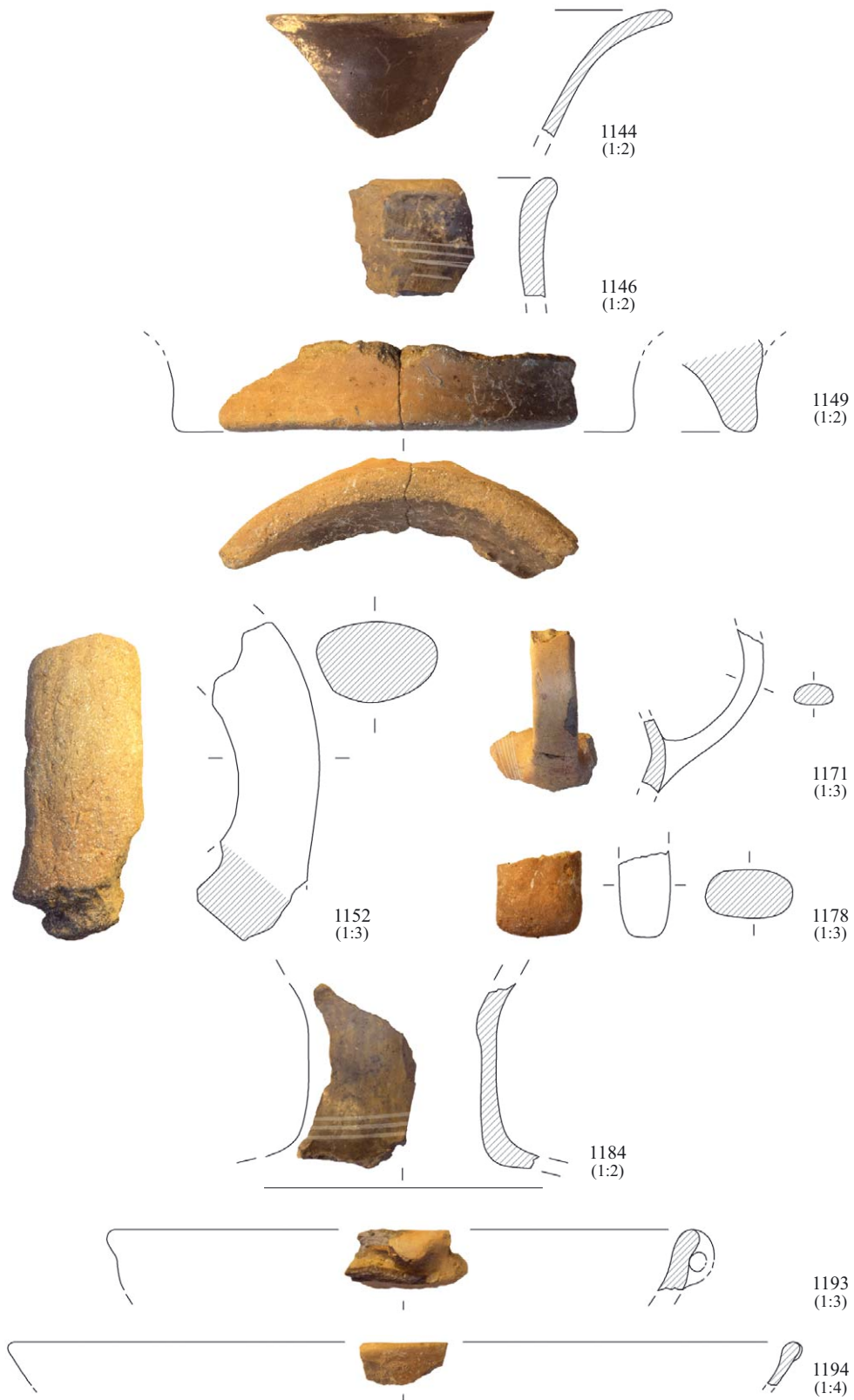

Planierung ÇuHö IV/Vb SE 5467 (1144, 1146, 1149, 1152, 1171, 1178, 1184)

ÇuHö Va SE 5434 (1193–1194)

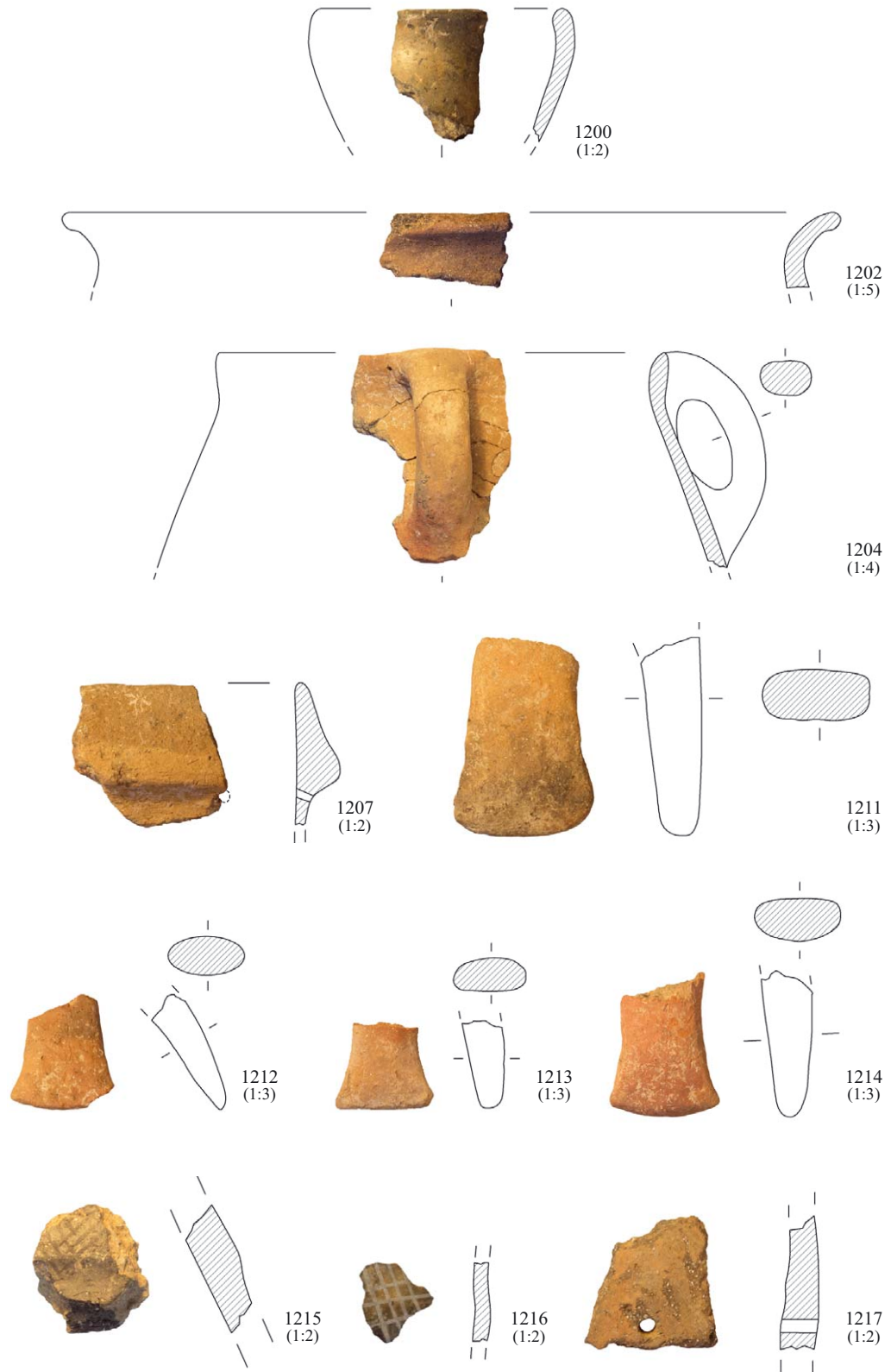

ÇuHö Va SE 5525 (1200, 1202, 1204, 1207, 1211-1217)

Tafel 42

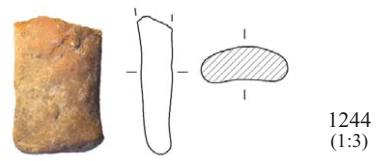

Planierung ÇuHö IV/Va SE 5409 (1222, 1224, 1233, 1235, 1244)

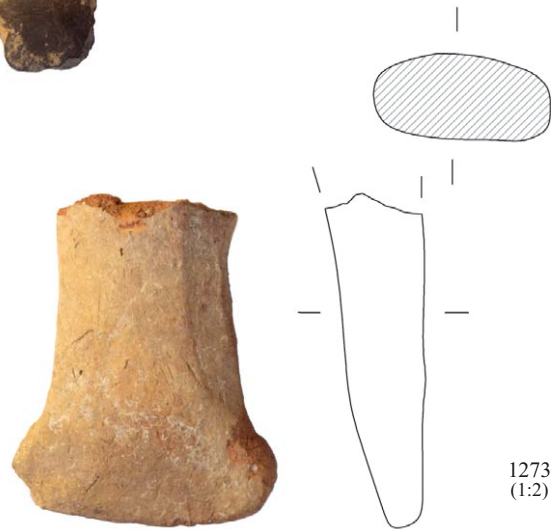
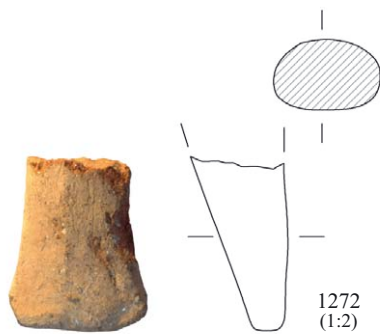
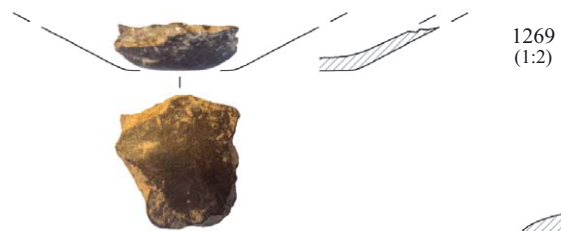
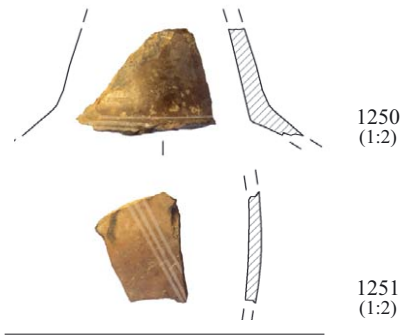

Planierung ÇuHö IV/Va SE 5409 (1250–1251); SE 5435 (1257, 1264, 1269, 1272–1273)

Tafel 44

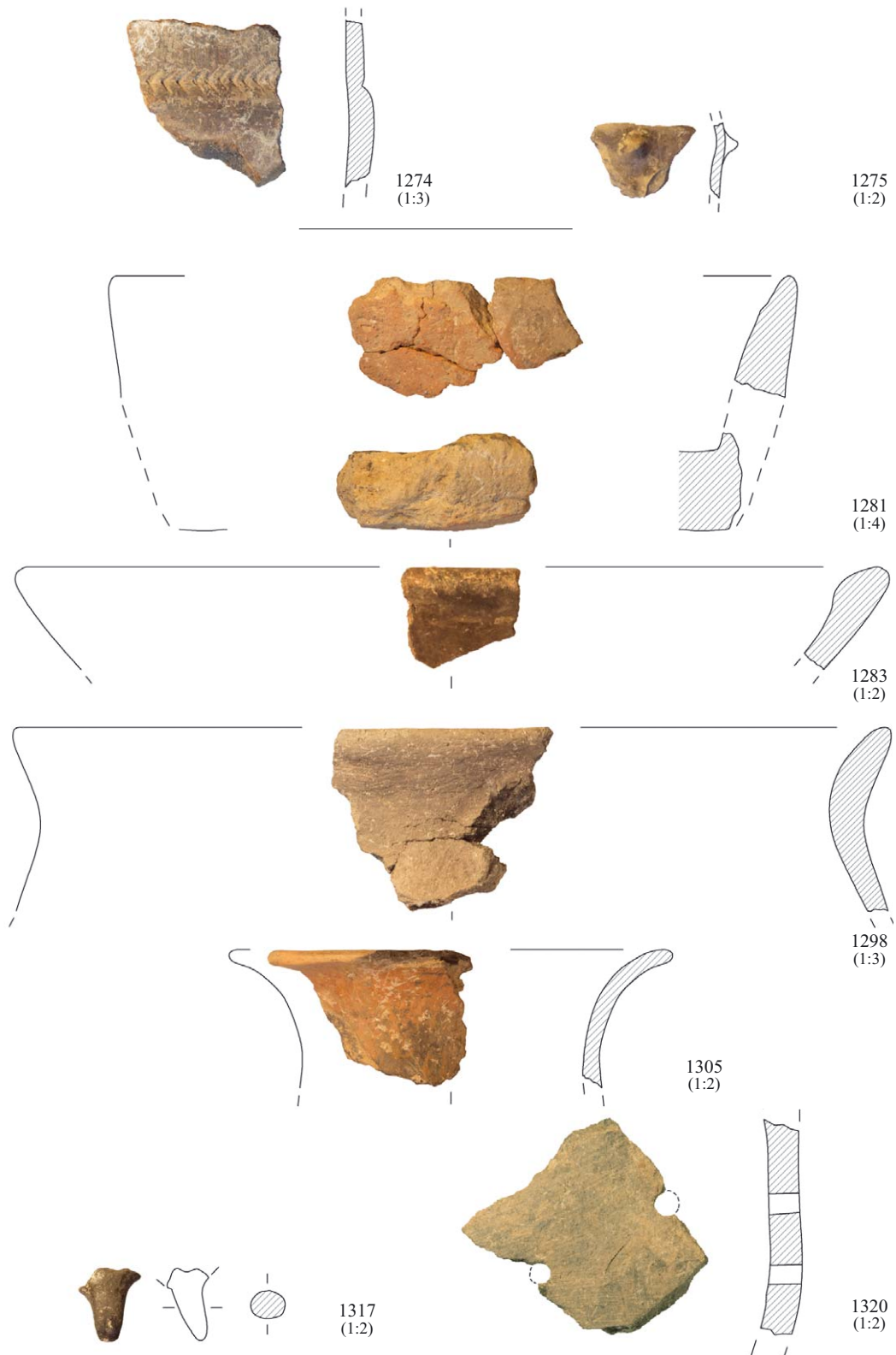

Planierung ÇuHö IV/Va SE 5435 (1274–1275); SE 5506 (1281, 1283, 1298, 1305, 1317, 1320)



1



2

- 1 Keramikauswahl der Subphase **ÇuHö VIa**
- 2 Keramikauswahl der Subphase **ÇuHö Vb**

Tafel 46



1



2



- 1 Fragment einer Schale des Typs S4Q (Kat.-Nr. 714) aus der Subphase **ÇuHö VIa**
2 Fragment einer Schale des Typs S4K (Kat.-Nr. 982) aus der Subphase **ÇuHö Vb**



1 Knickrandschalenfragmente aus der Subphase **ÇuHö VIa**
2 Fragmente von Vorratsgefäßen der WG 15 aus der Subphase **ÇuHö Vb**

Tafel 48



1



2

- 1 Lineare Weißbemalung auf Scherben der Subphase **ÇuHö VIa**
- 2 Lineare Weißbemalung auf Scherben der Subphase **ÇuHö Vb**



1 Lineare Weißbemalung auf Scherben der Subphase **ÇuHö Va**
2 Verschiedene Fußtypen der Subphase **ÇuHö Vb**

Tafel 50



1



2



- 1 *Cheese pot*-Fragment (Kat.-Nr. 543) der Subphase **ÇuHö VIa** (Außenansicht)
- 2 *Cheese pot*-Fragment (Kat.-Nr. 543) der Subphase **ÇuHö VIa** (Innenansicht)



1



2

- 1 *Cheese pot*-Fragment (Kat.-Nr. 543) der Subphase **ÇuHö VIa** (Außenansicht)
2 *Cheese pot*-Fragment (Kat.-Nr. 543) der Subphase **ÇuHö VIa** (Innenansicht)

Tafel 52

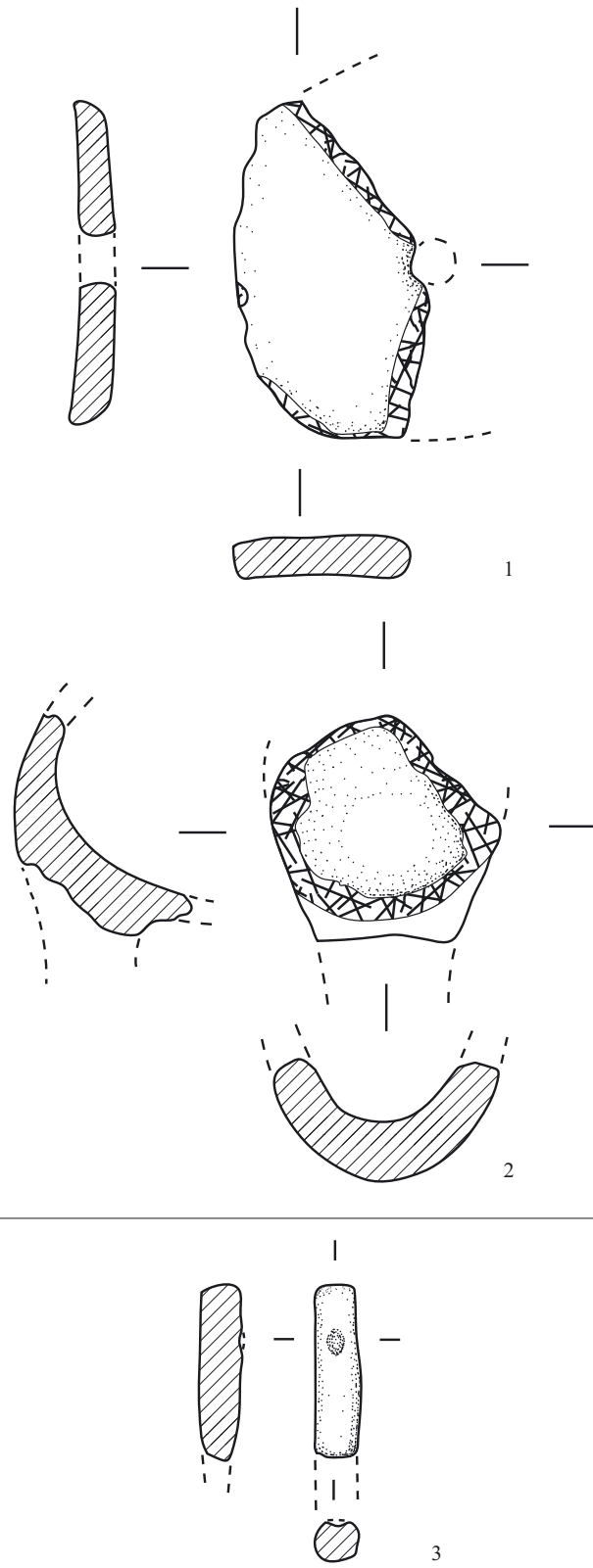

ÇuHö VII Grabenverfüllung A: SE 1351 (1); SE 1735 (2); Grabenverfüllung B: SE 4553 (3)
M 1:1

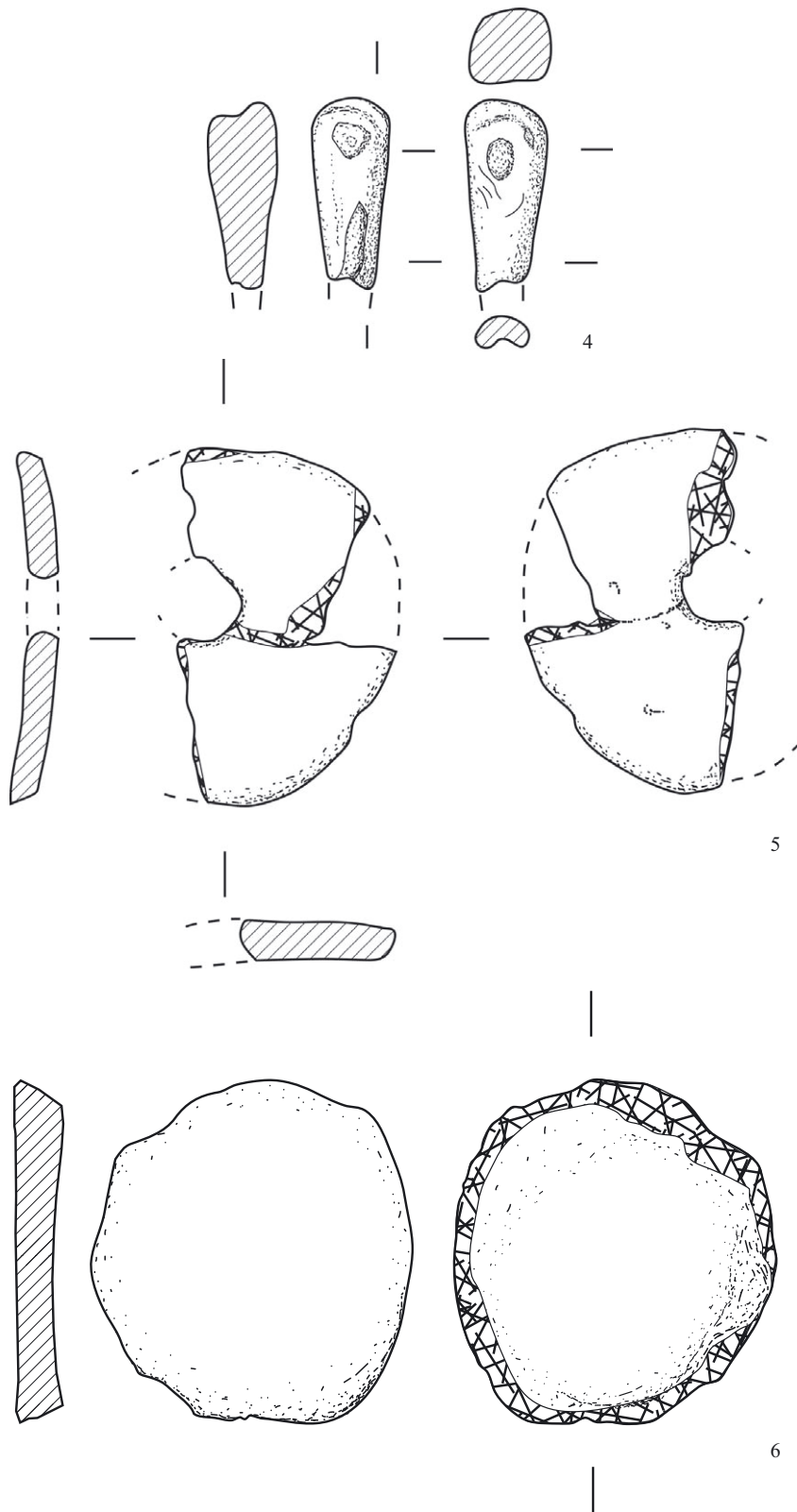

Planierung ÇuHö VIb/VII Grabenverfüllung C: SE 1215 (4); SE 1307 (5, 6)
M 1:1

Tafel 54

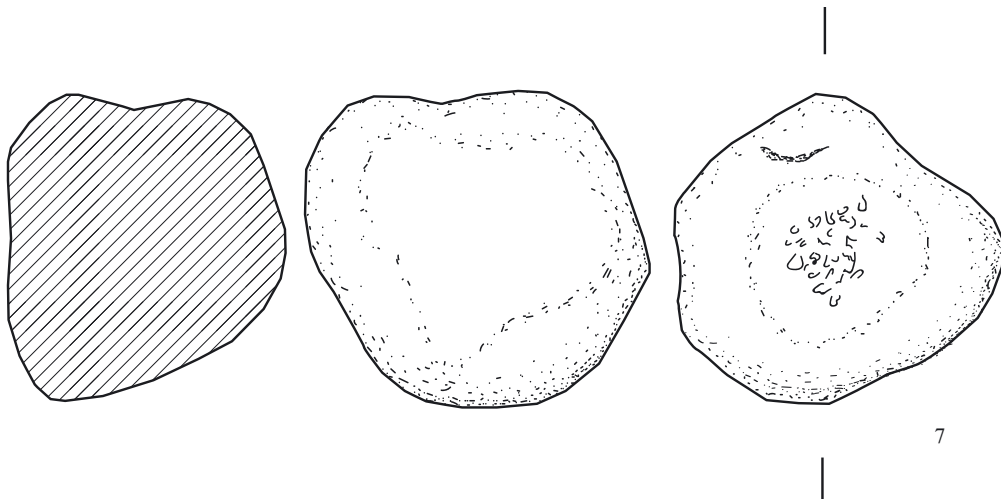

7

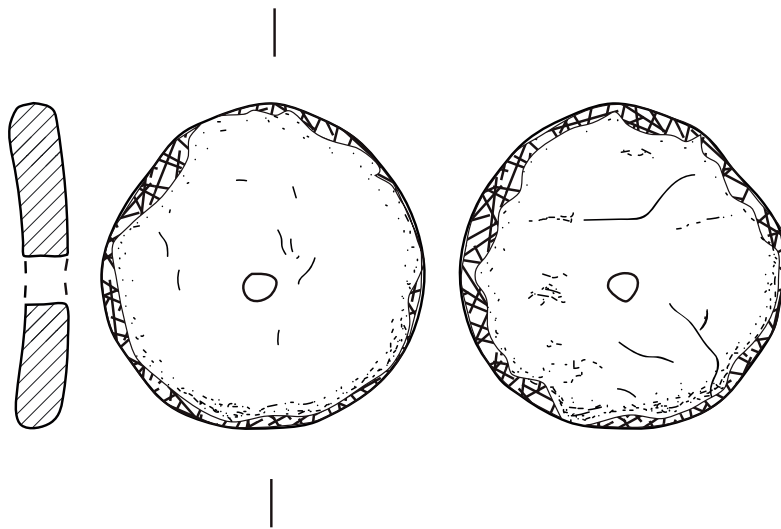

9

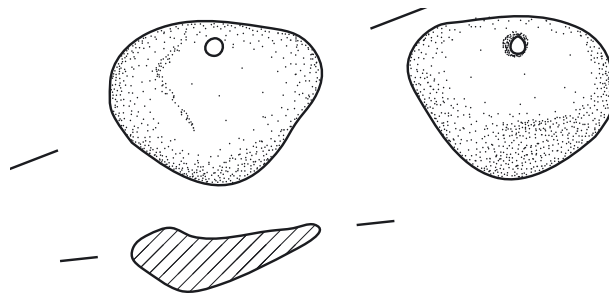

10

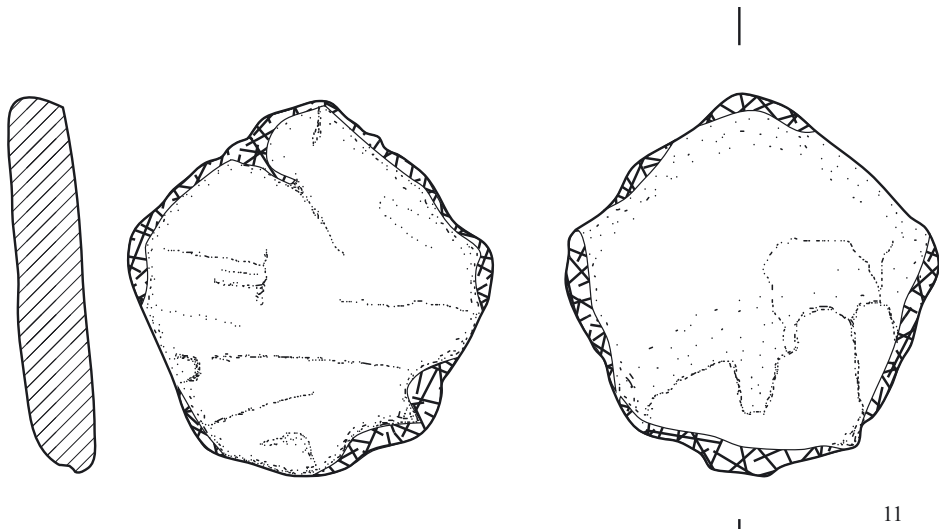

11

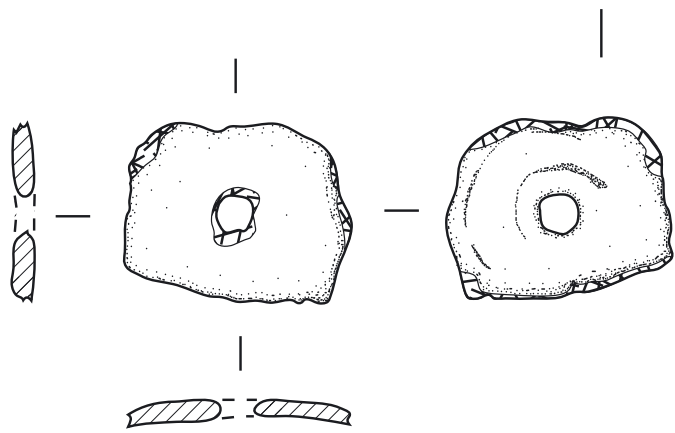

12

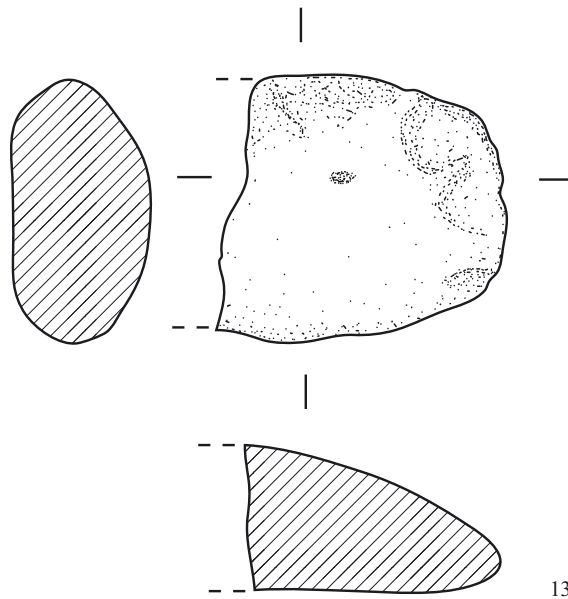

13

Planierung ÇuHö VIb/VII Planierschicht: SE 1449 (11); SE 4511 (12, 13)
M 1:1

Tafel 56

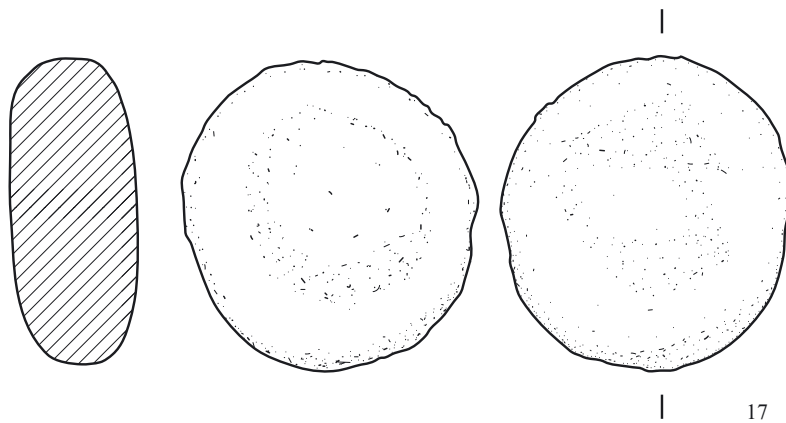
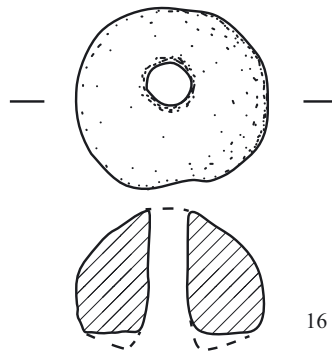
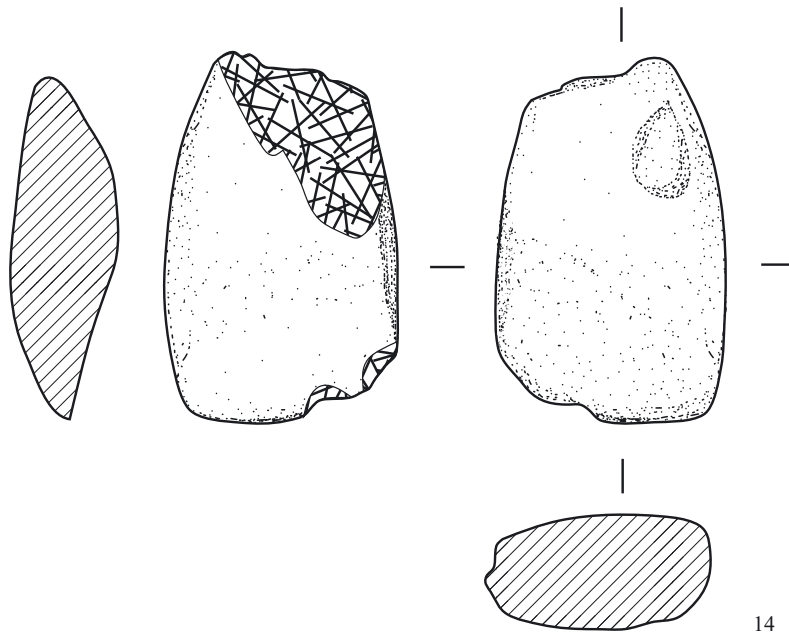

Planierung ÇuHö VIb/VII Planierschicht: SE 4511 (14)
Planierung ÇuHö VIa/VII SE 1446 (16); SE 1463 (17)
M 1:1 (17 = M 1:2)

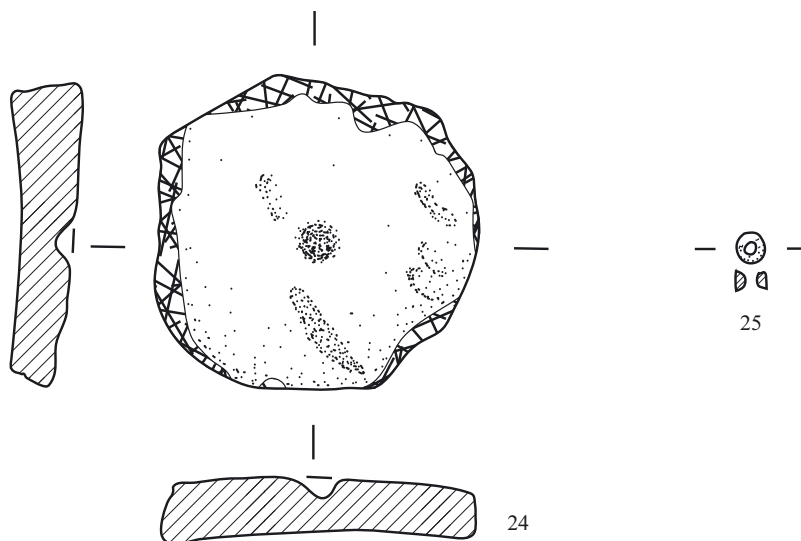
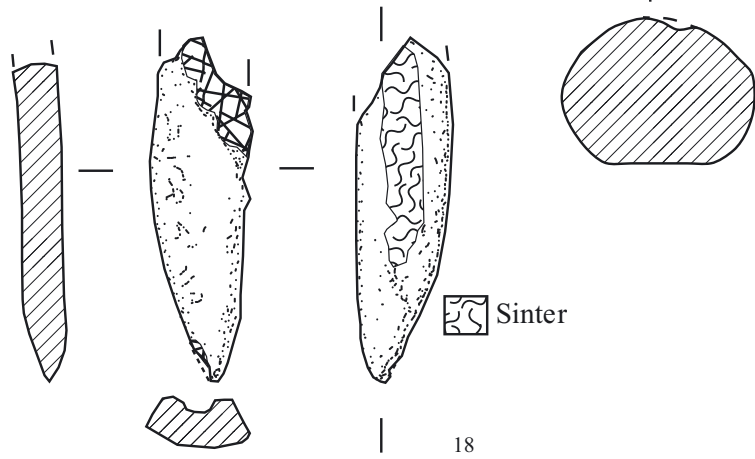
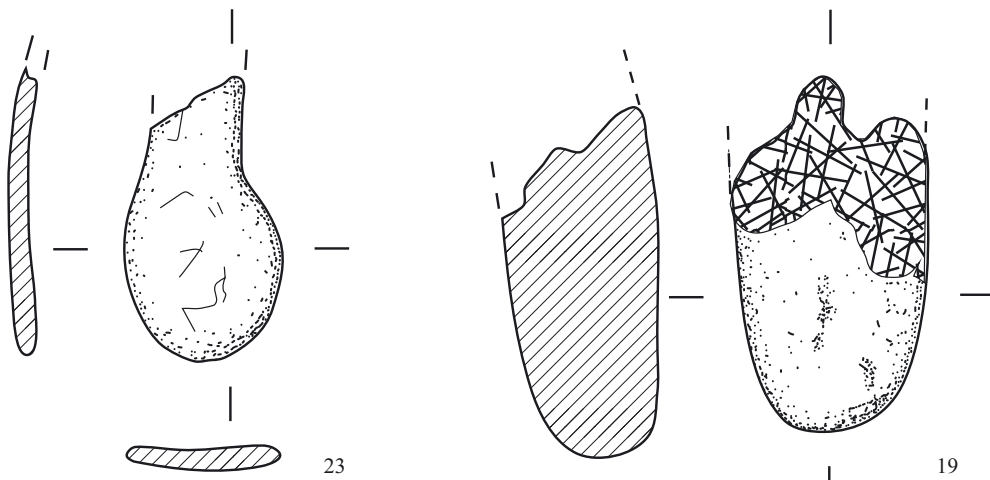

Planierung ÇuHö VIa/VIb SE 5591 (18, 19); SE 5592 (23)
 Planierung ÇuHö IV/VIb SE 5324 (24, 25)

M 1:1

Tafel 58

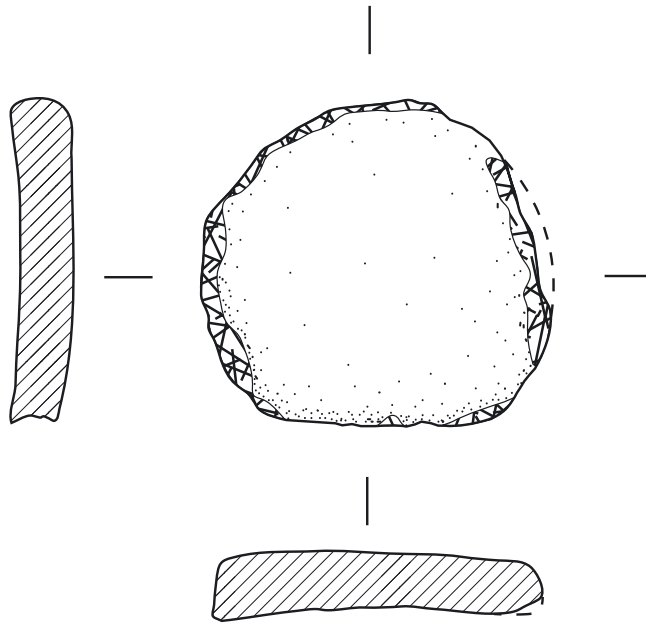

26

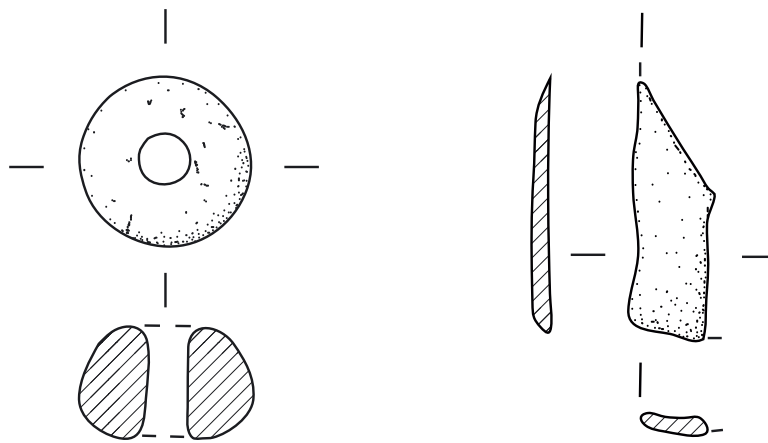

29

28

Planierung ÇuHö IV/VIb SE 5324 (26)

ÇuHö VIa SE 5590 (28, 29)

M 1:1

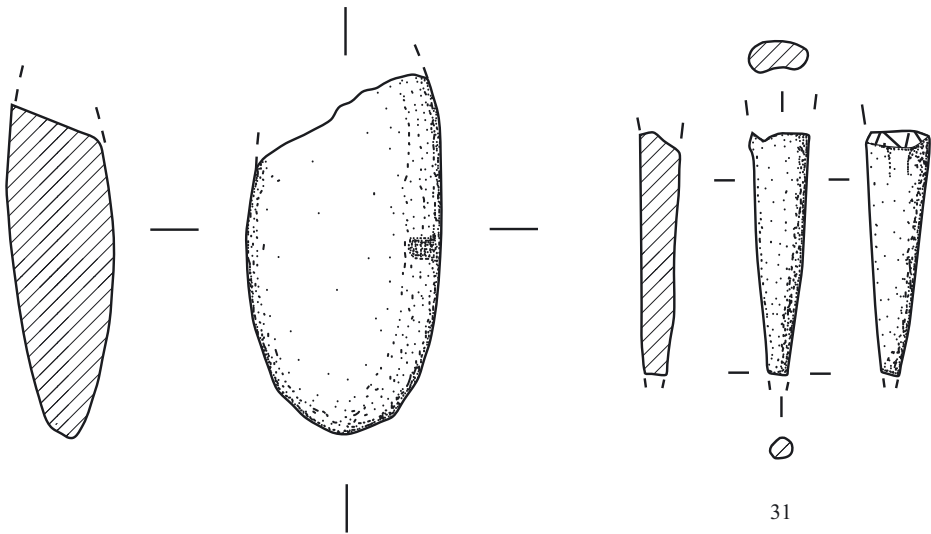

30

31

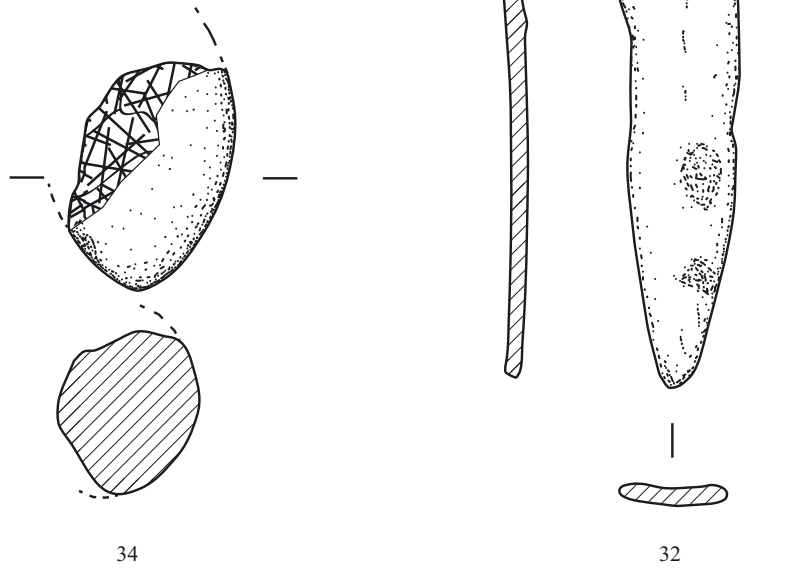

34

32

Tafel 60

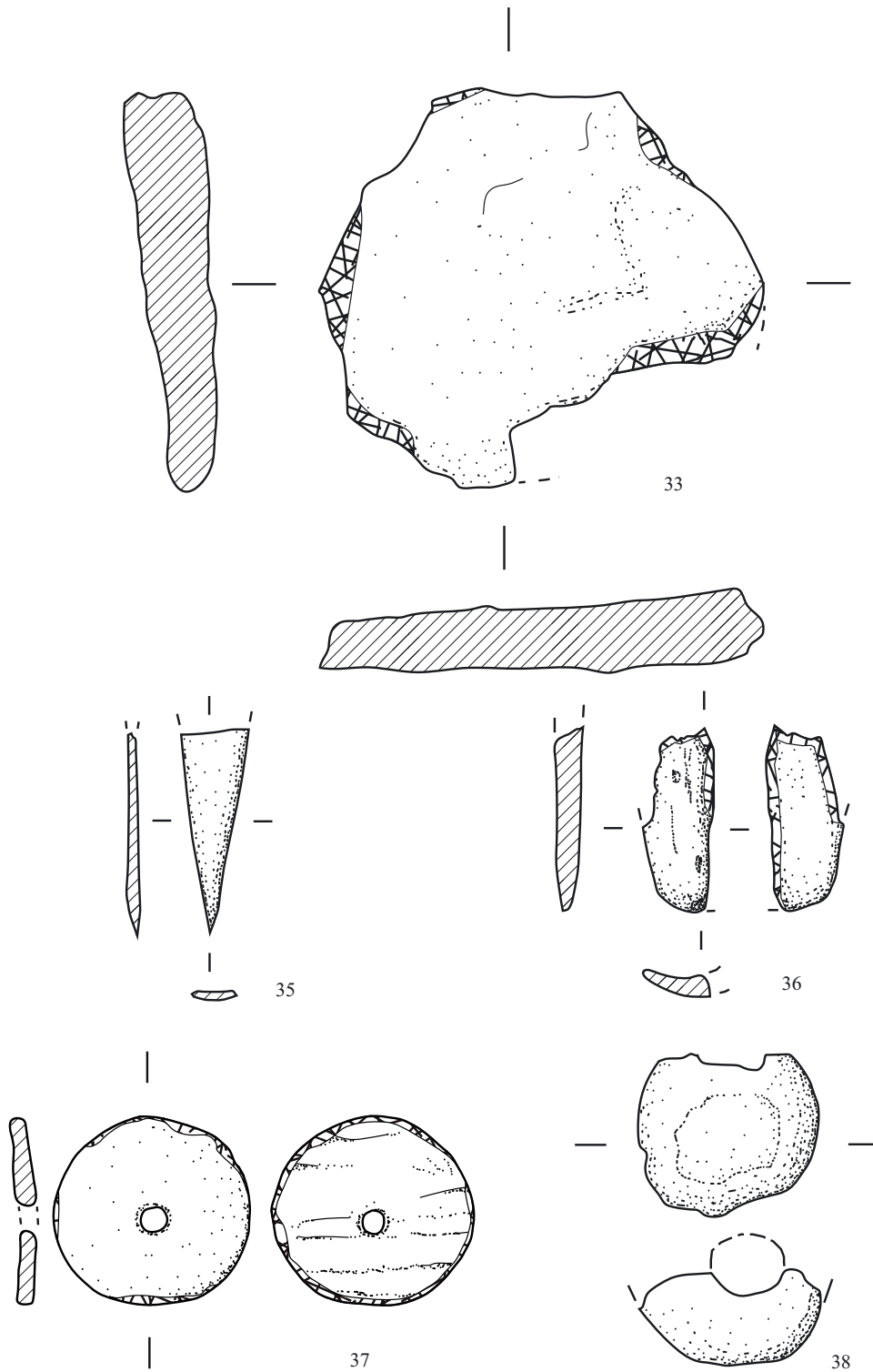

Planierung ÇuHö Vb/VIa SE 5465 (33); SE 5543 (35-38)
M 1:1

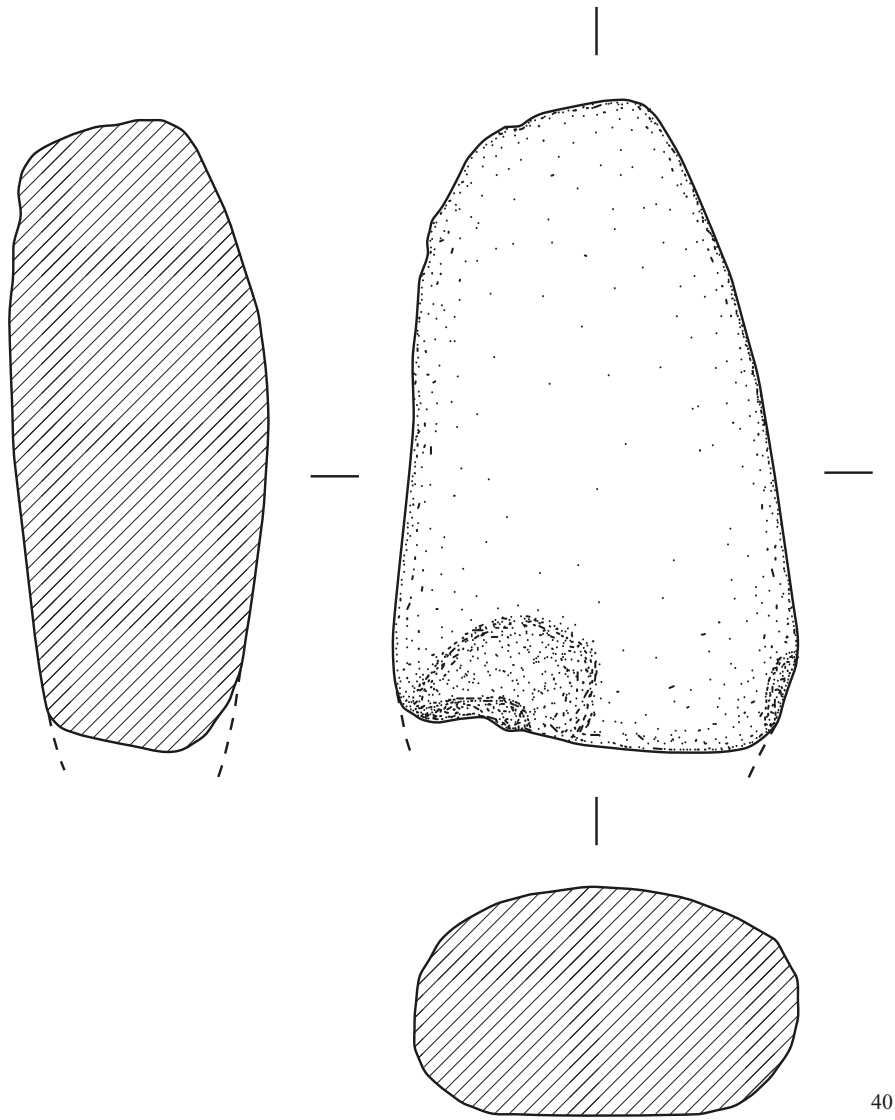

40

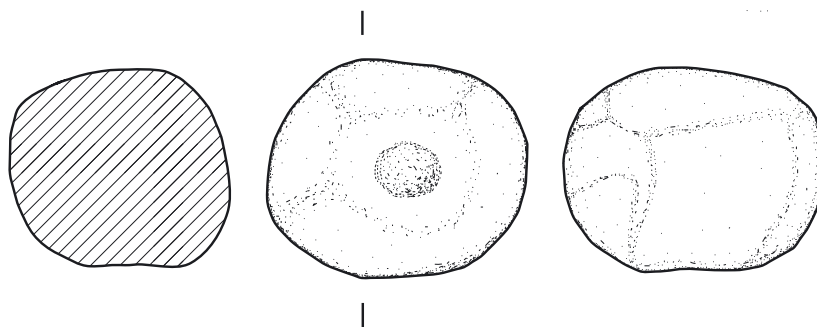

42

Planierung ÇuHö IV/V1a SE 5422 (40)

ÇuHö Vb SE 5325 (42)

M 1:1 (42 = M 1:2)

Tafel 62

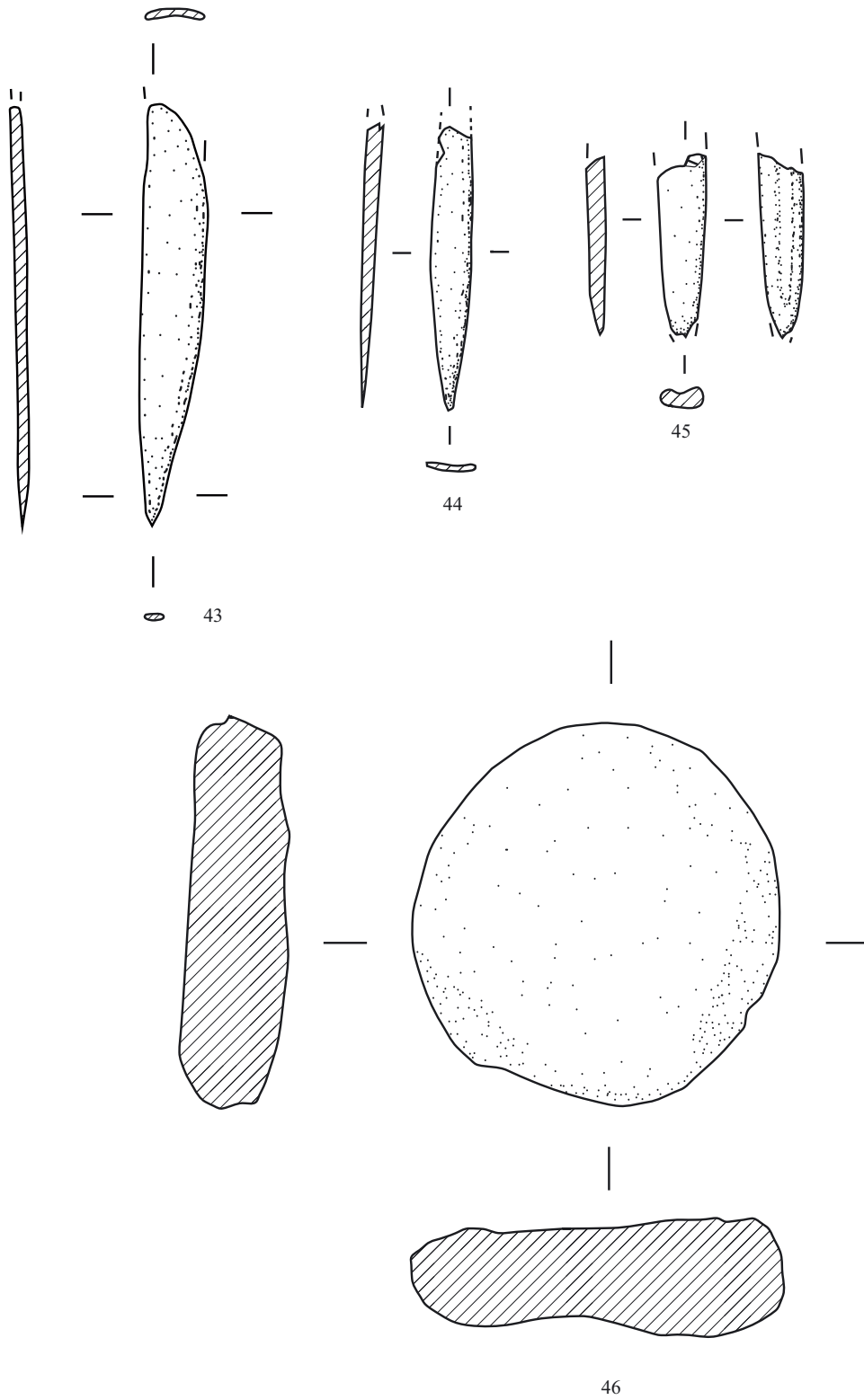

ÇuHö Vb SE 5325 (43-45); SE 5326 (46)
M 1:1

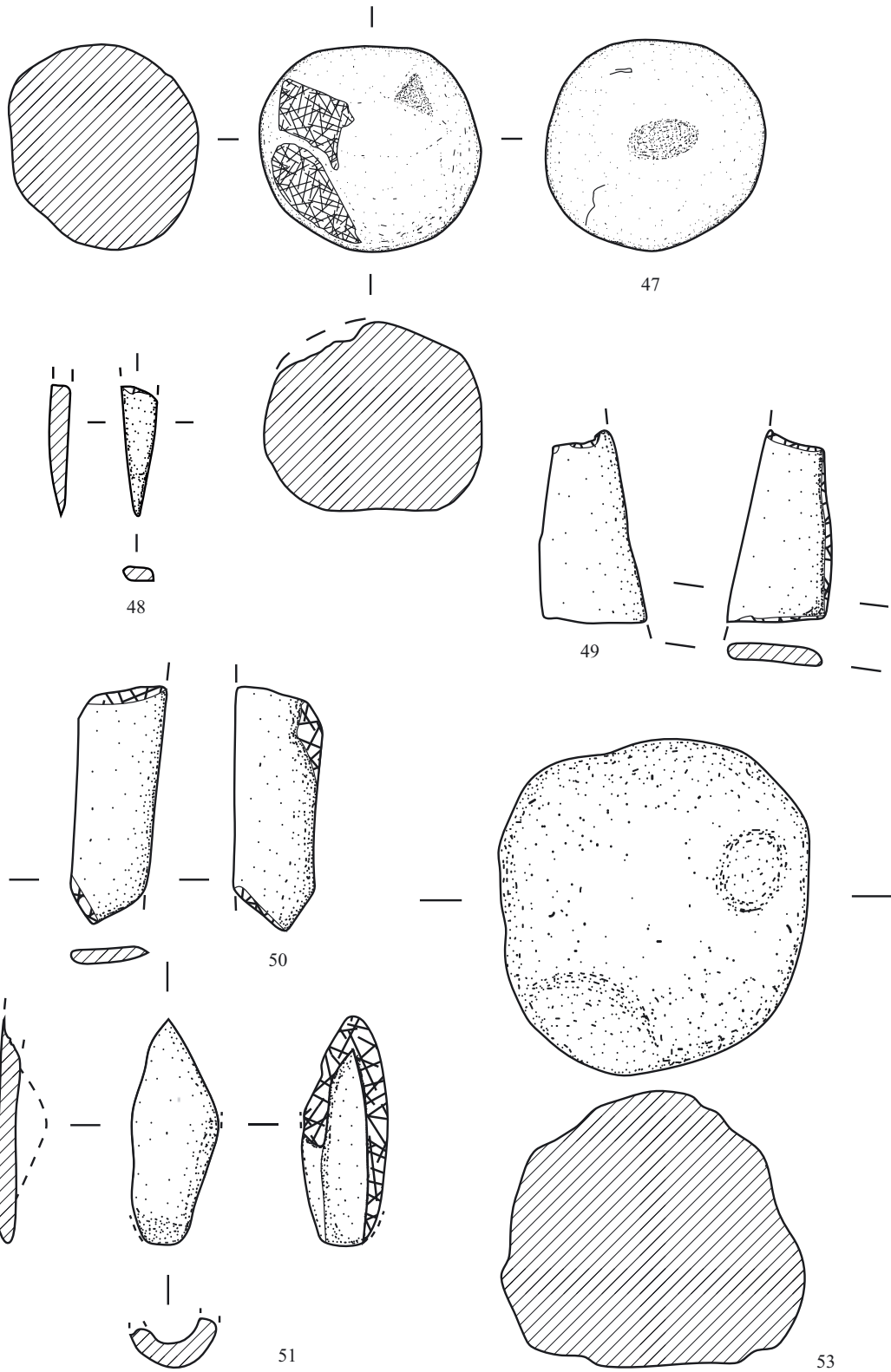

ÇuHö Vb SE 5338 (47); SE 5490 (48-51); SE 5496 (53)
M 1:1 (47 = M 1:2)

Tafel 64

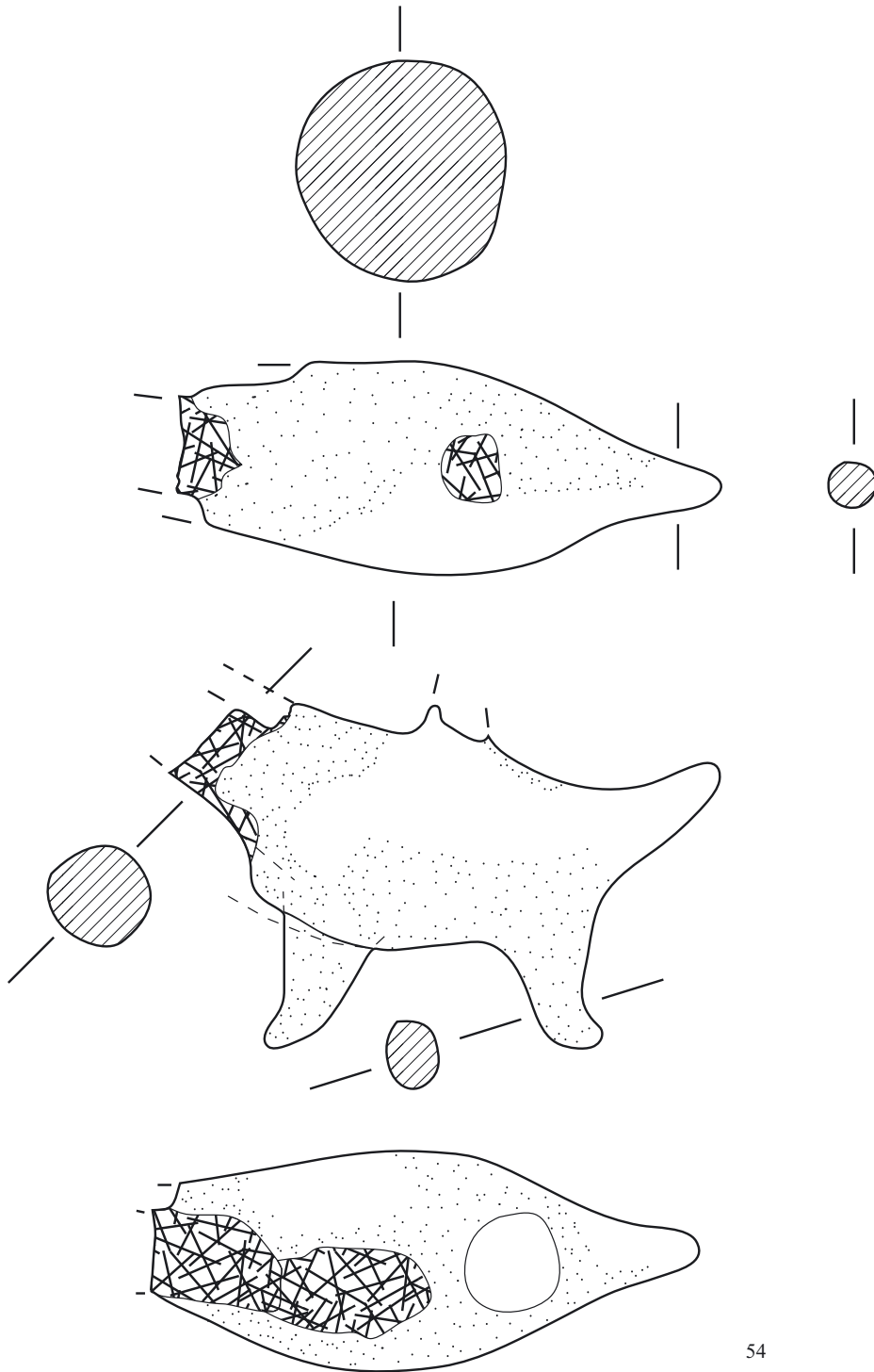

54

ÇuH6 Vb SE 5502 (54)
M 1:1



55

Planierung ÇuHö Va/Vb SE 5432 (55)
M 1:4

Tafel 66

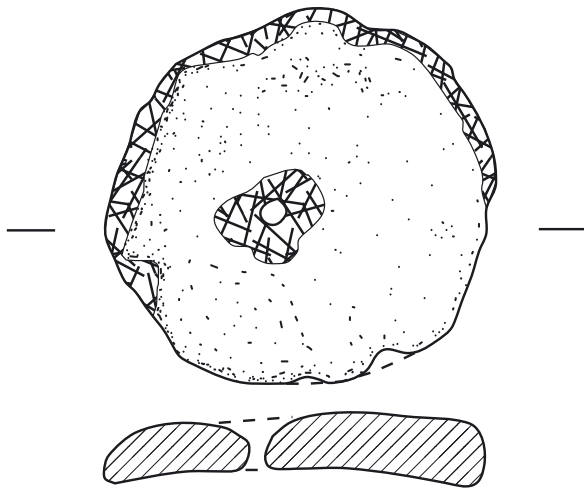

56

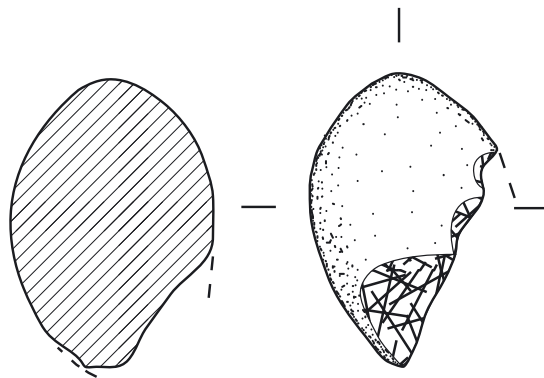

57

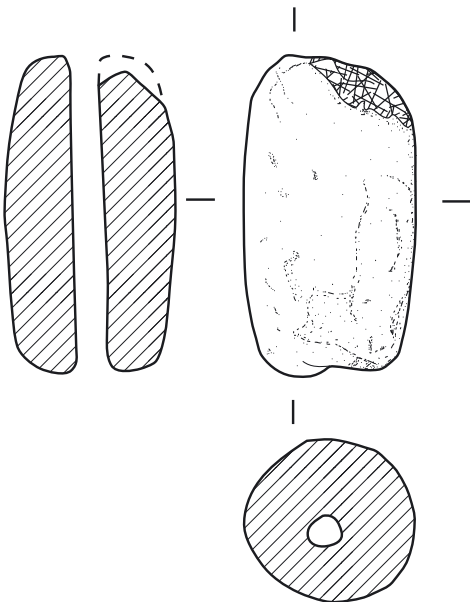

58

Planierung ÇuHö Va/Vb SE 5477 (56-58)
M 1:1 (58 = M 1:2)

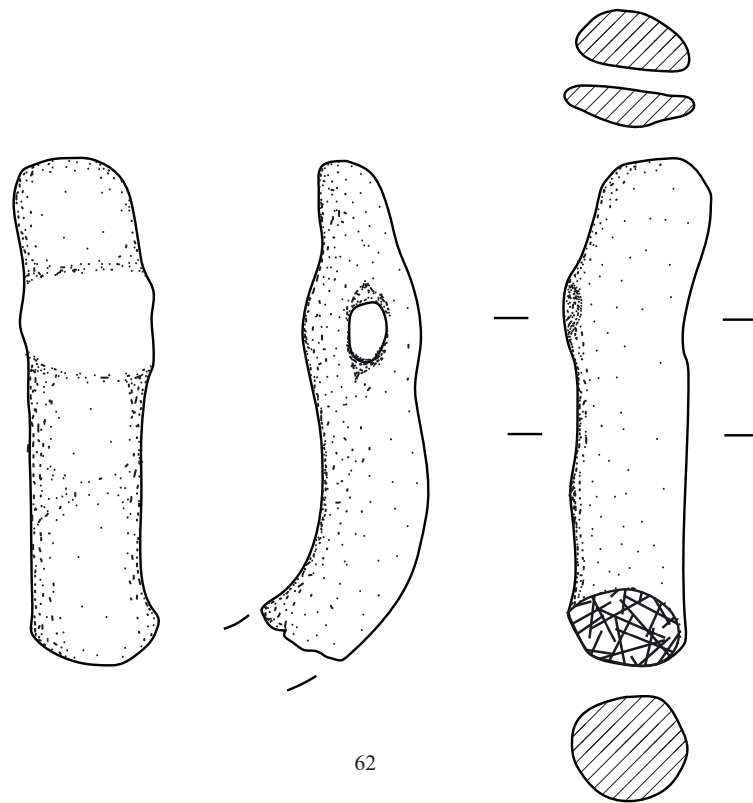
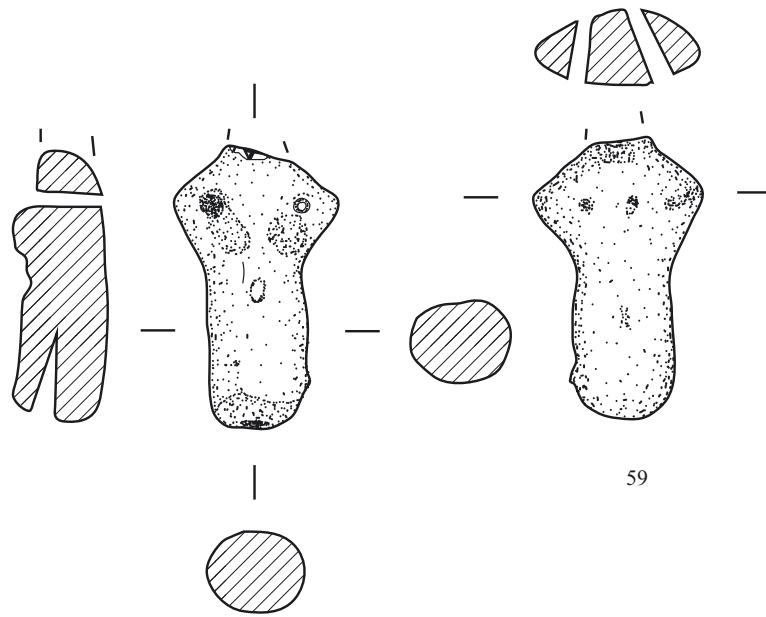

Planierung ÇuHö IV/Vb SE 5302 (59); SE 5467 (62)
M 1:1

Tafel 68

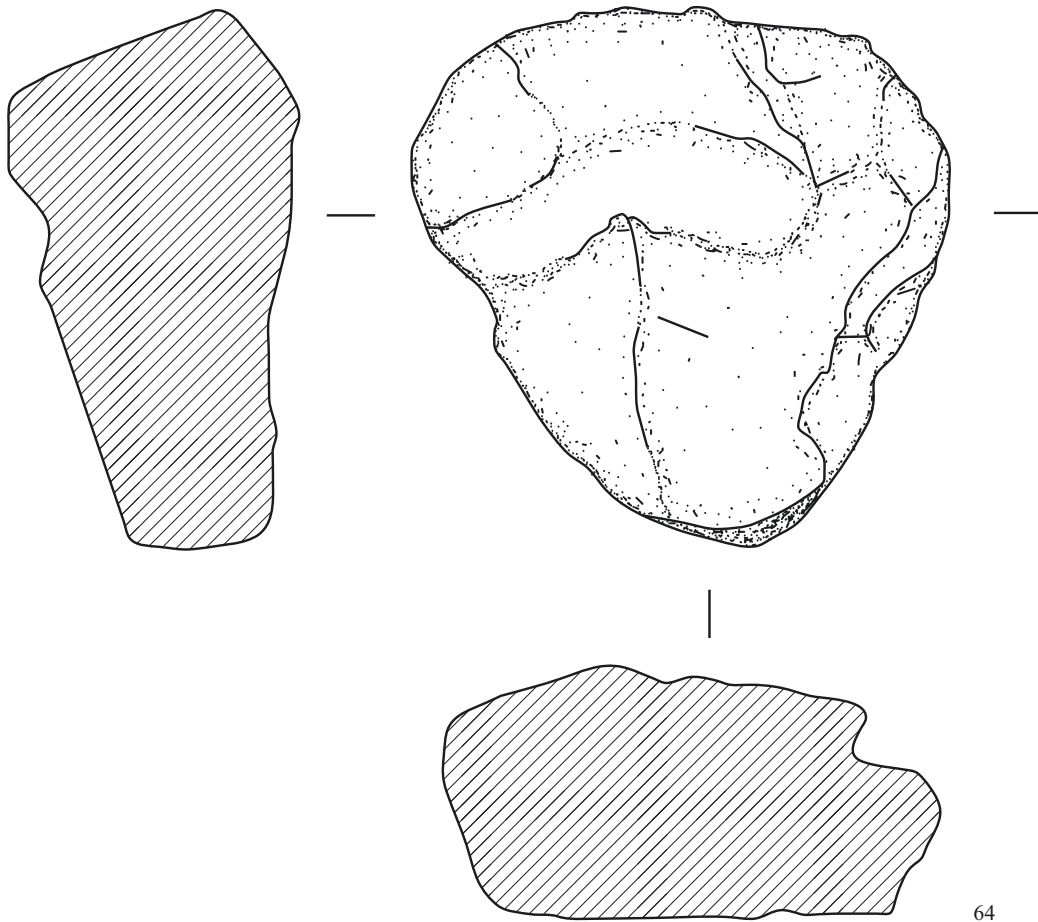
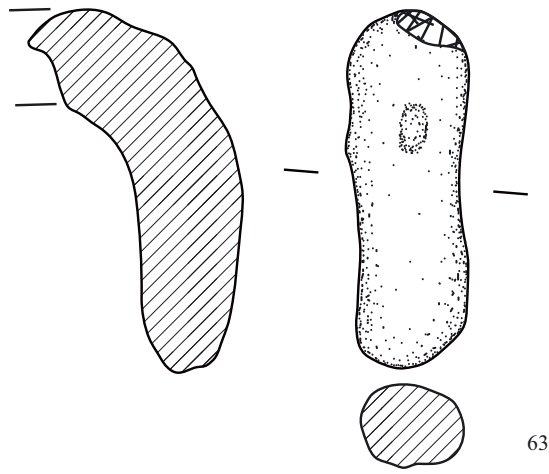

Planierung ÇuHö IV/Vb SE 5467 (63-64)
M 1:1

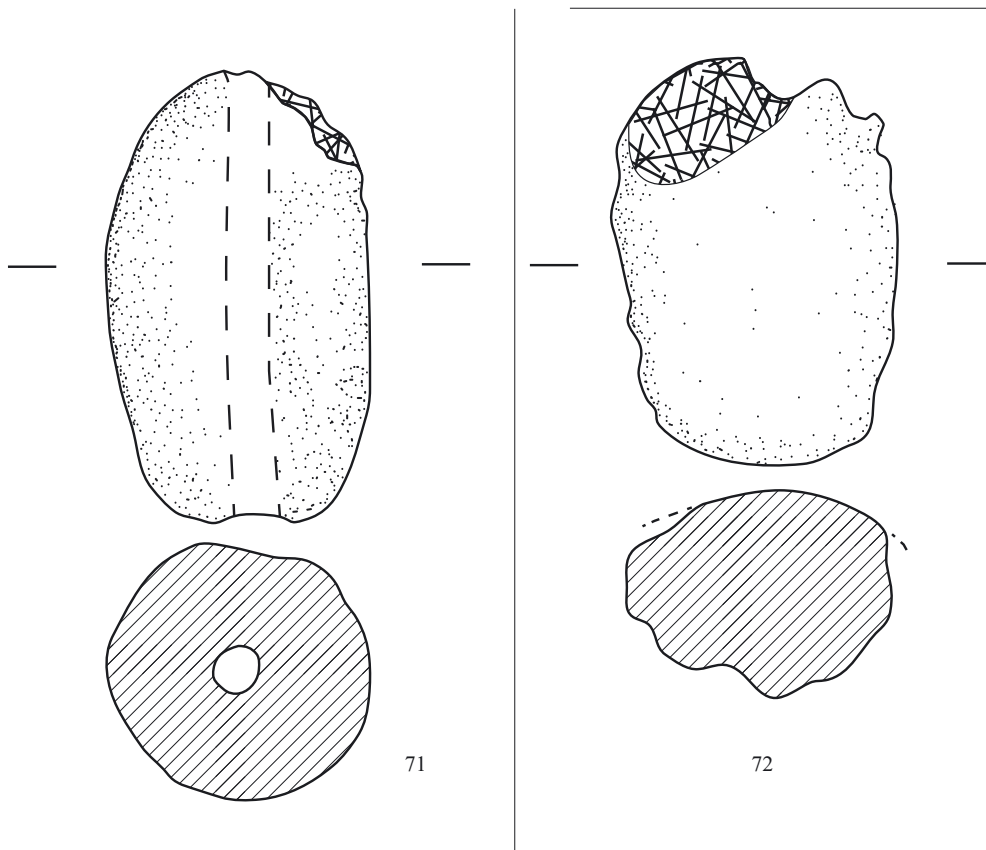
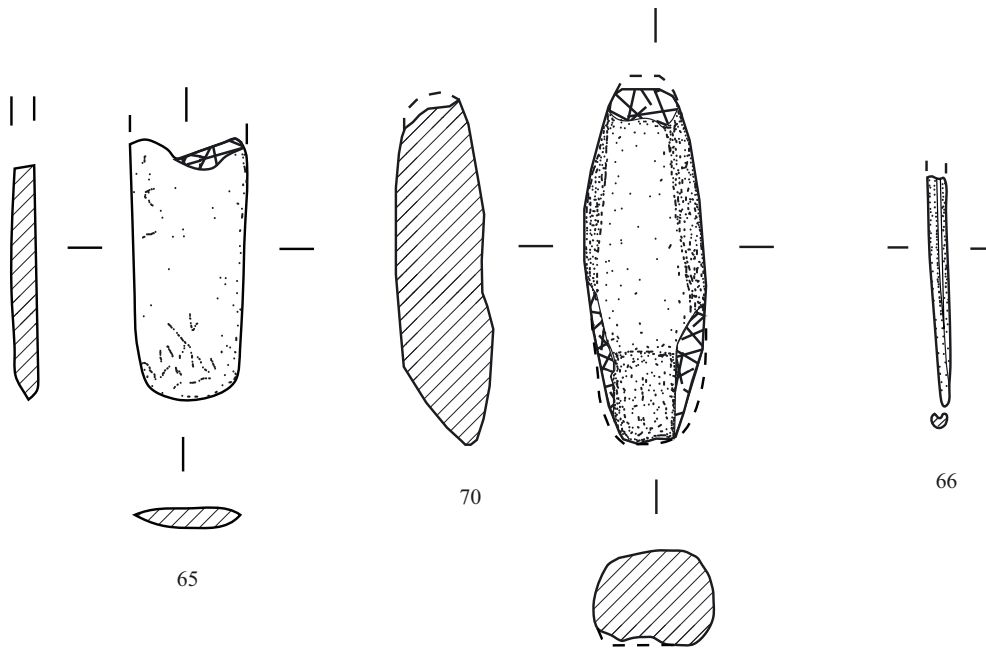

Planierung ÇuHö IV/Vb SE 5467 (65–66, 70–71)
ÇuHö Va SE 5434 (72)
M 1:1

Tafel 70

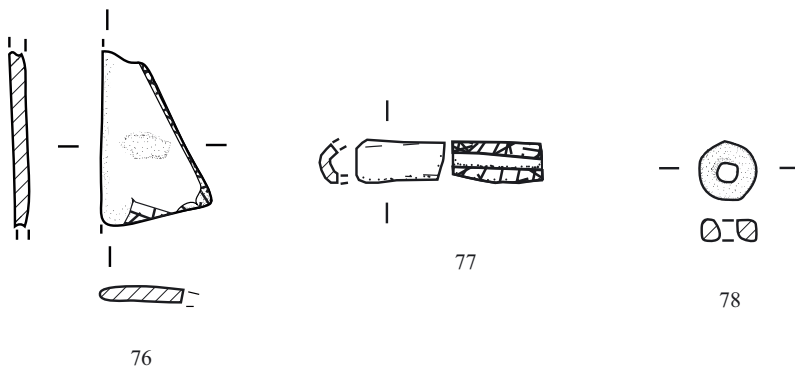
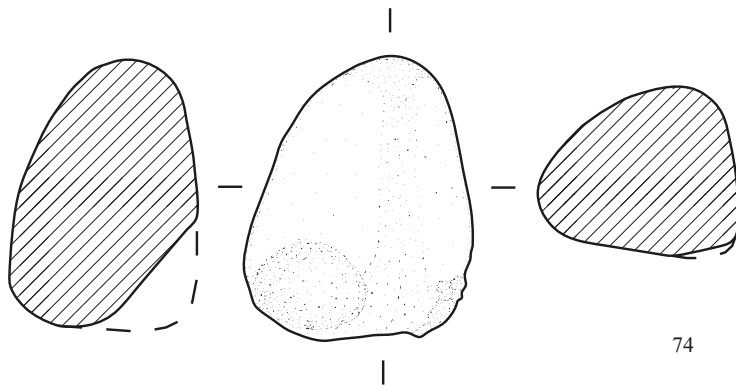
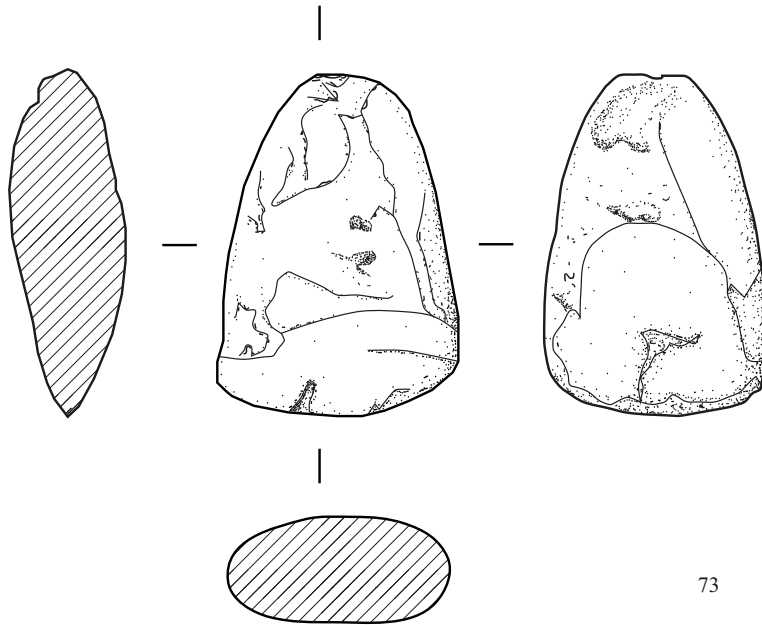

Planierung ÇuHö IV/Va SE 5409 (73–74, 76–78)
M 1:1 (74 = M 1:2)

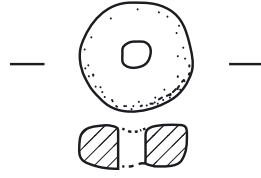

79

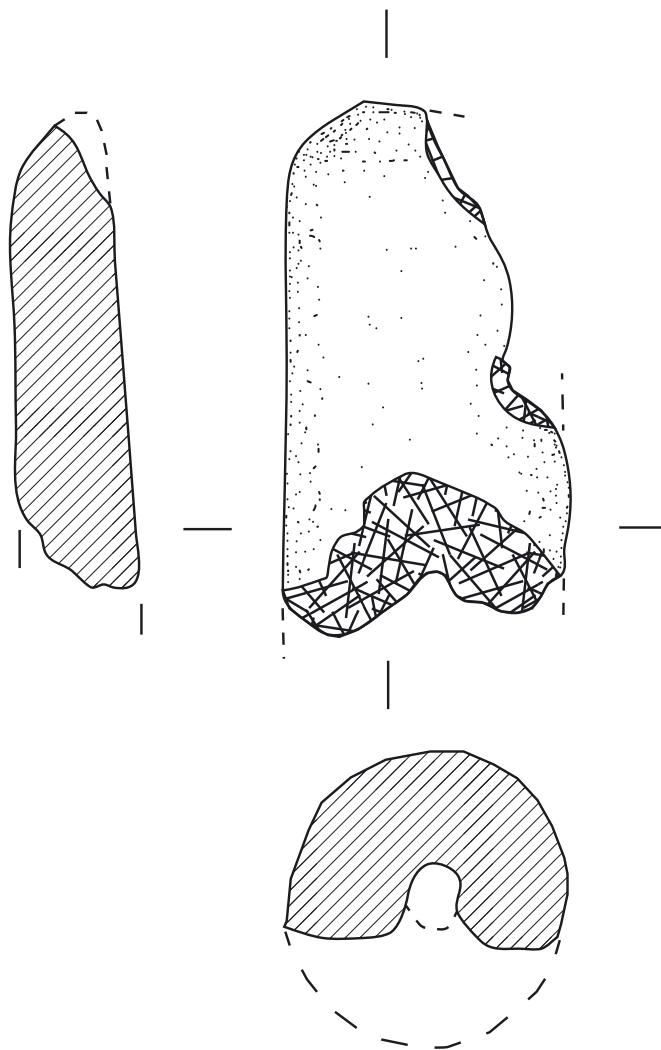

80

Tafel 72

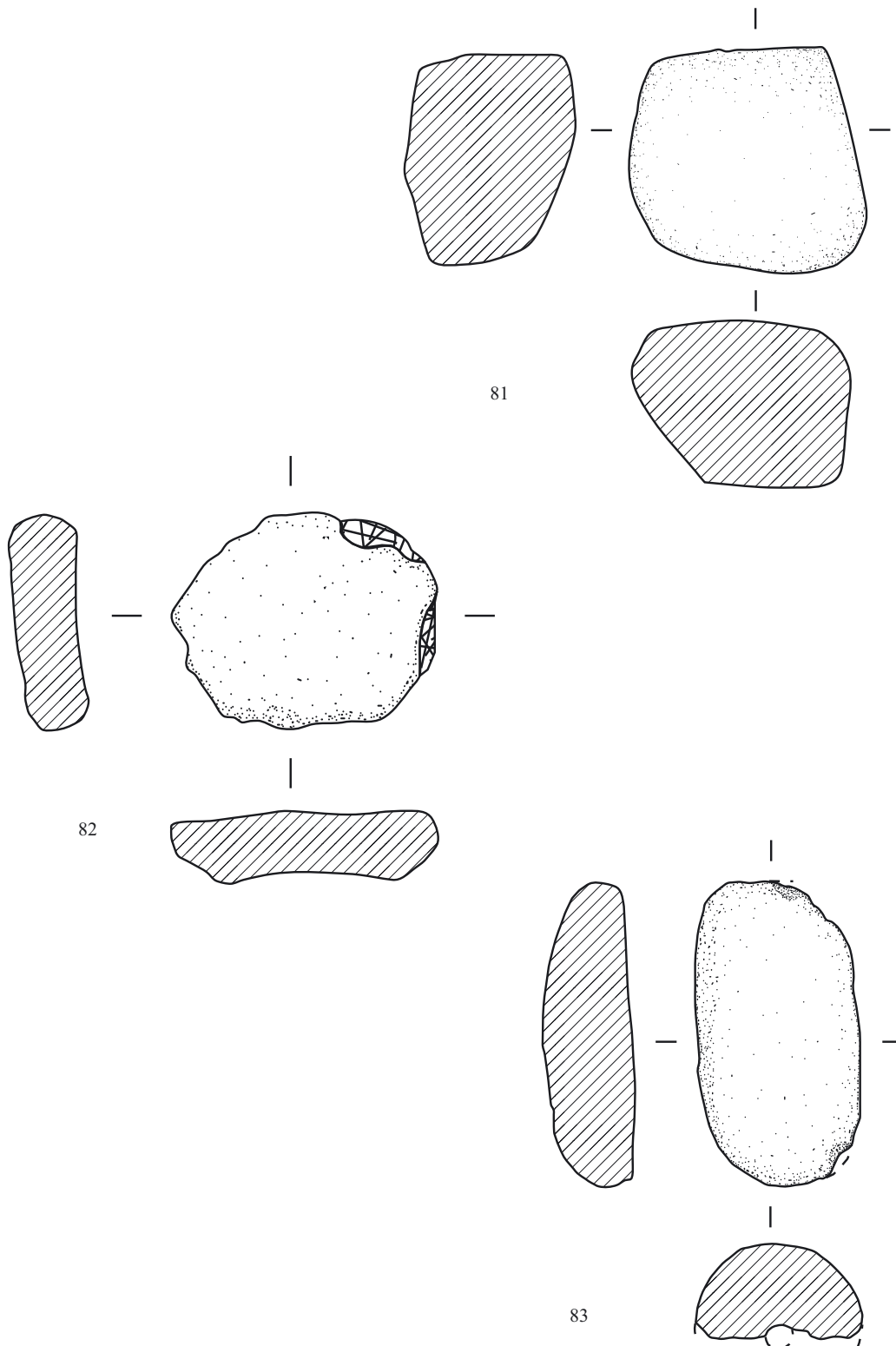

Planierung ÇuHö IV/Va SE 5506 (81-83)
M 1:1 (81; 83 = M 1:2)

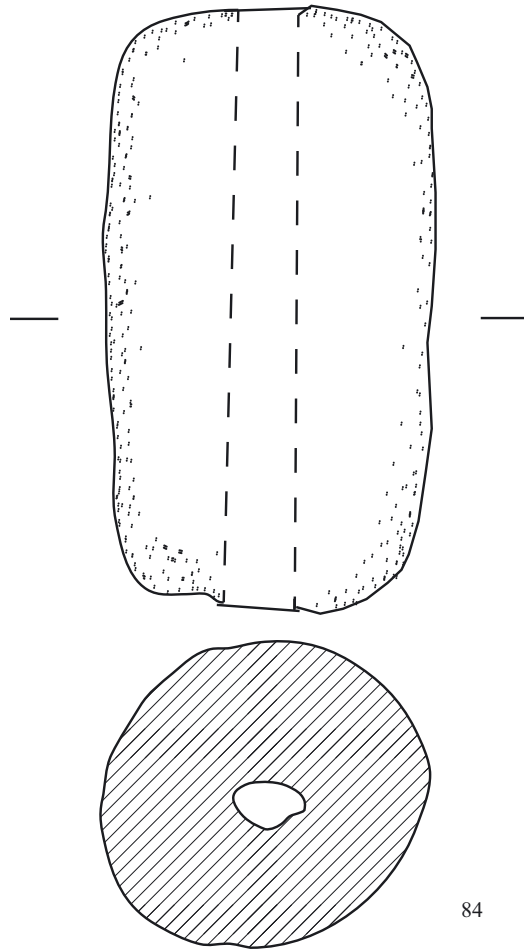

84

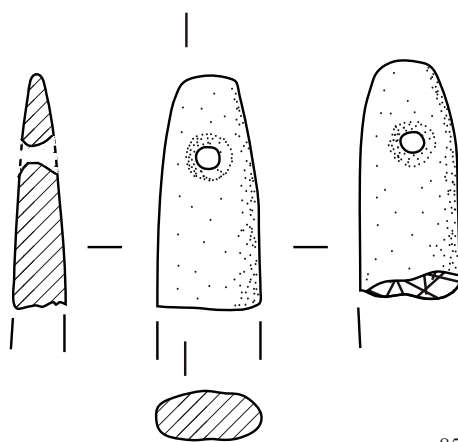

85

Planierung ÇuHö IV/Va SE 5506 (84); SE 5519 (85)
M 1:1

Tafel 74

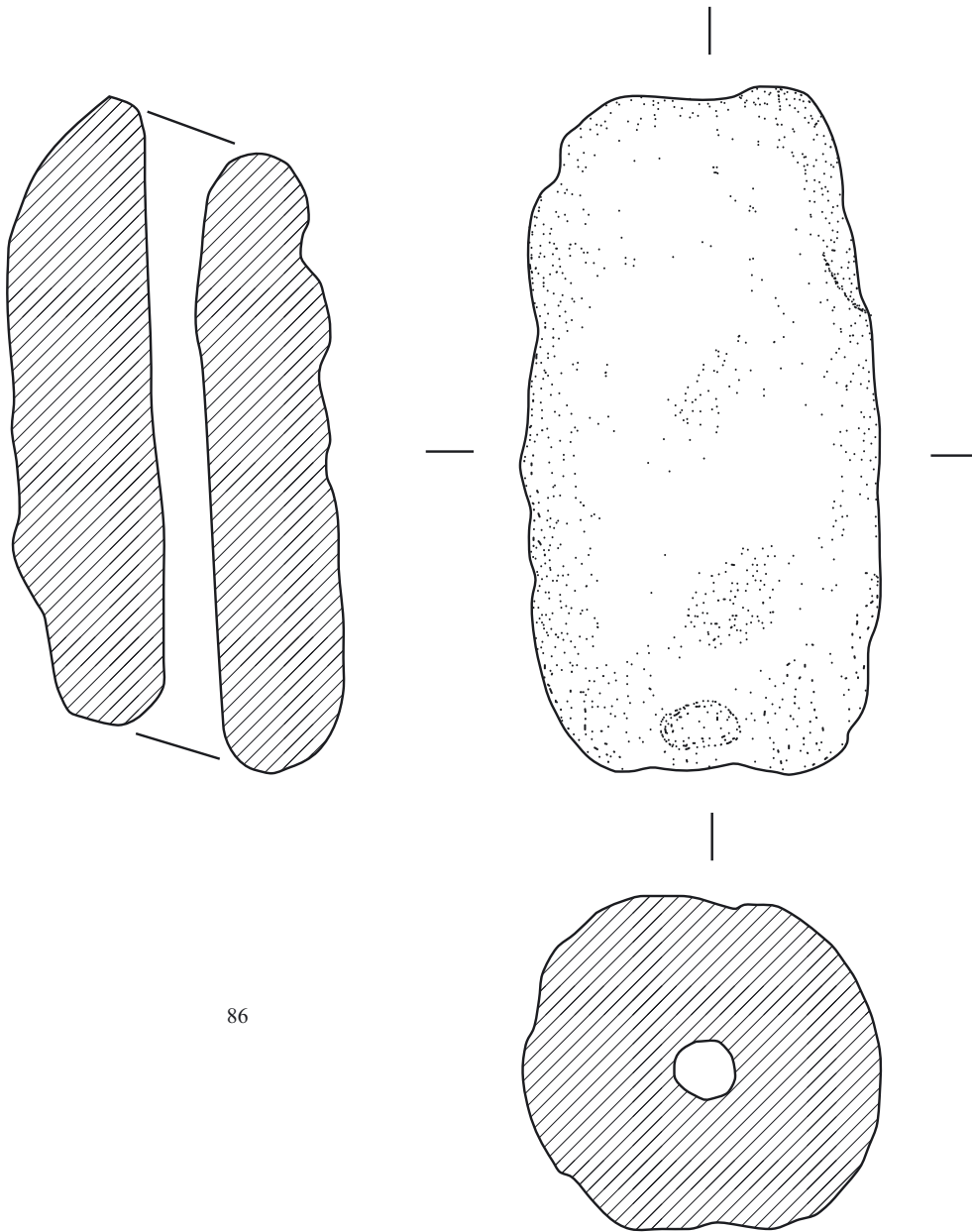

86

Planierung ÇuHö IV/Va SE 5523 (86)
M 1:1

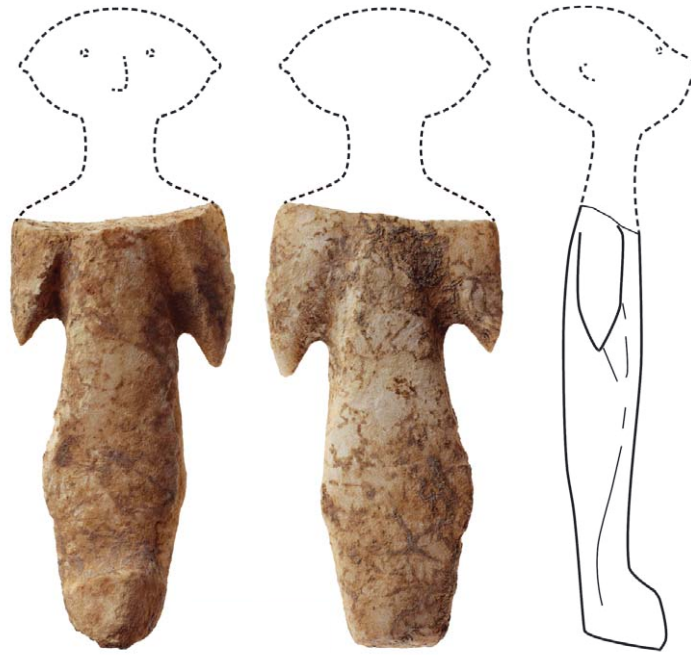

87

ÇuHö I SE 5001 (87)
M 1:1

Tafel 76



2



11



10

ÇuHö VII Grabenverfüllung A: SE 1735 (2)
Planierung ÇuHö VIb/VII Planierschicht: SE 1449 (11–10)



12



14



16



Planierung ÇuHö VIb/VII Planierschicht: SE 4511 (12, 14)
Planierung ÇuHö VIa/VIb SE 1446 (16)

Tafel 78



19



23

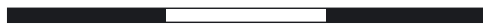

Planierung ÇuHö VIa/VIb SE 5591 (19); SE 5592 (23)



24



25



29

Planierung ÇuHö IV/VIb SE 5324 (24–25)
ÇuHö VIa SE 5590 (29)

Tafel 80



30



34

Planierung ÇuHö Vb/VIa SE 5465 (30, 34)



35



37

Tafel 82



42



43



47





49



53



55

ÇuHö Vb SE 5490 (49); SE 5496 (53)
Planierung ÇuHö Va/Vb SE 5432 (55)

Tafel 84



54



57



58

ÇuHö Vb SE 5502 (54)
Planierung ÇuHö Va/Vb SE 5477 (57-58)



59



65

Tafel 86



62



70

Planierung ÇuHö IV/Vb SE 5467 (62, 70)



71



77



73

Planierung ÇuHö IV/Vb SE 5467 (71)
Planierung ÇuHö IV/Va SE 5409 (73, 77)

Tafel 88



78



83



84

Planierung ÇuHö IV/Va SE 5409 (78); SE 5506 (83–84)



85

Tafel 90

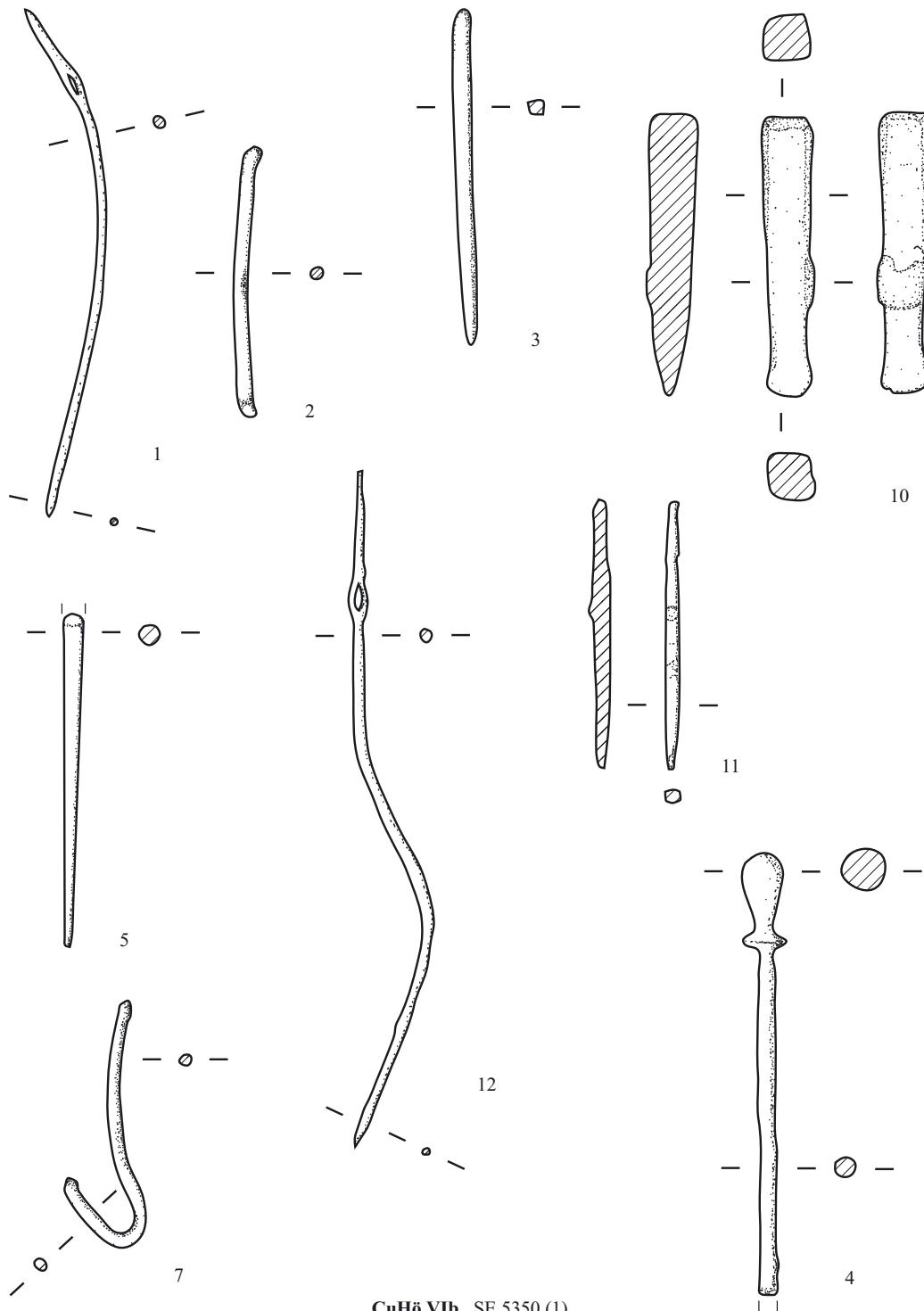

ÇuHö VIb SE 5350 (1)
Planierung ÇuHö VIa/VIb SE 5591 (2)
Planierung ÇuHö IV/VIb SE 5324 (3)
Planierung ÇuHö Vb/VIa SE 5465 (4-5); SE 5539 (7)
Planierung ÇuHö Va/Vb SE 5533 (10)
Planierung ÇuHö IV/Vb SE 5467 (11)
Planierung ÇuHö IV/Va SE 5409 (12)

M 1:1



1



9



12

Planierung ÇuHö VIb SE 5350 (1)
Planierung ÇuHö Vb SE 5326 (9)
Planierung ÇuHö IV/Va SE 5409 (12)

Tafel 92



Planierung ÇuHö Vb/VIa SE 5465 (4-5)



Planierung ÇuHö Va/Vb SE 5533 (10)
Auswahl Metallfunde ÇuHö VI-V

Tafel 94

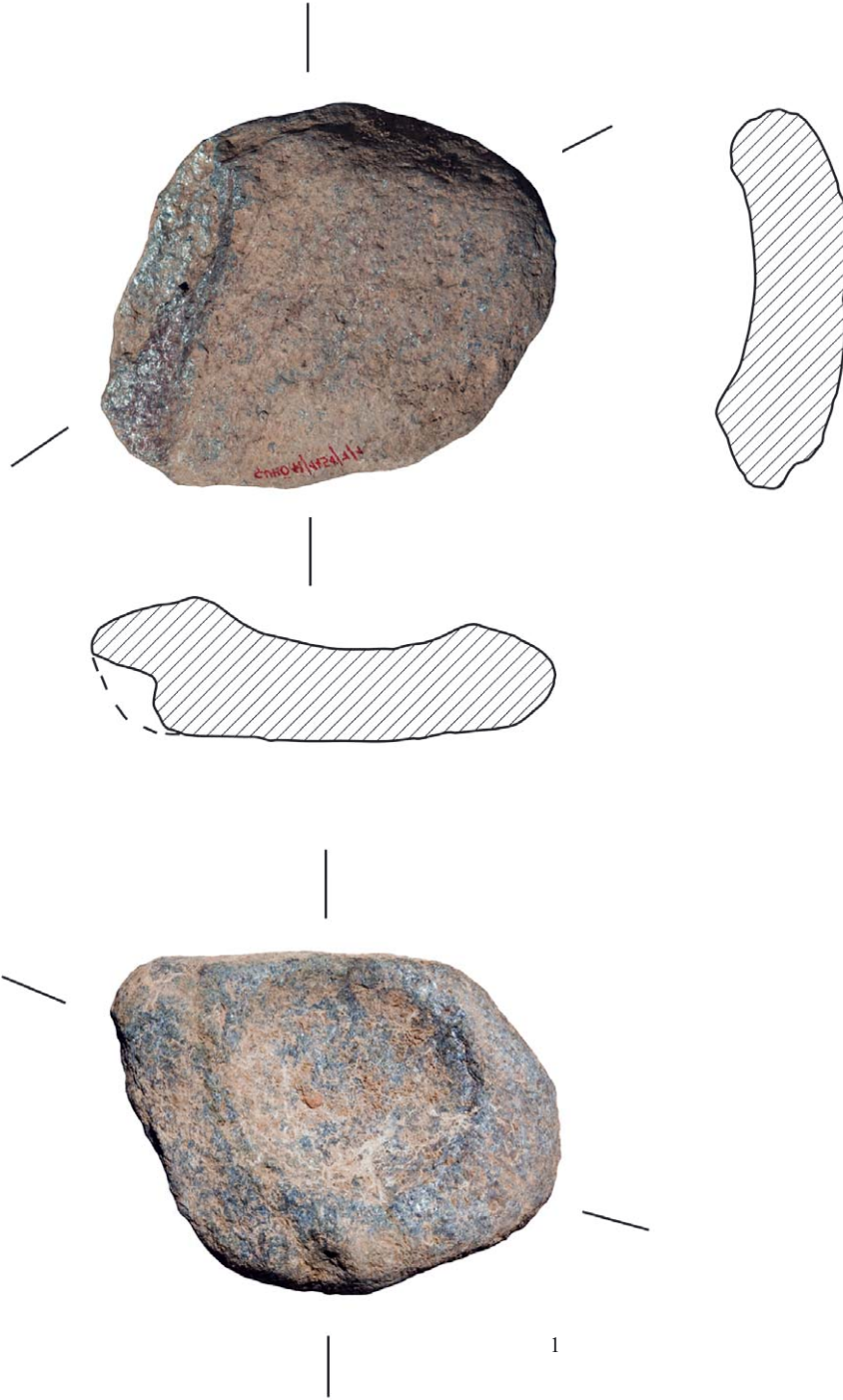

ÇuHö VIb SE 1451 (1)
M 1:4



ÇuHö Vb SE 5330 (2)
M 1:6

Tafel 96

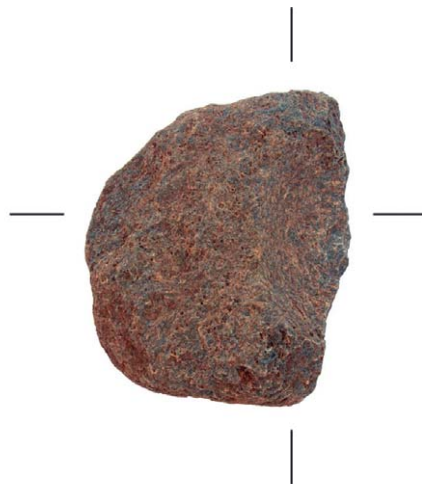
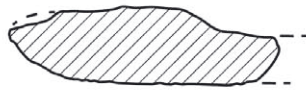
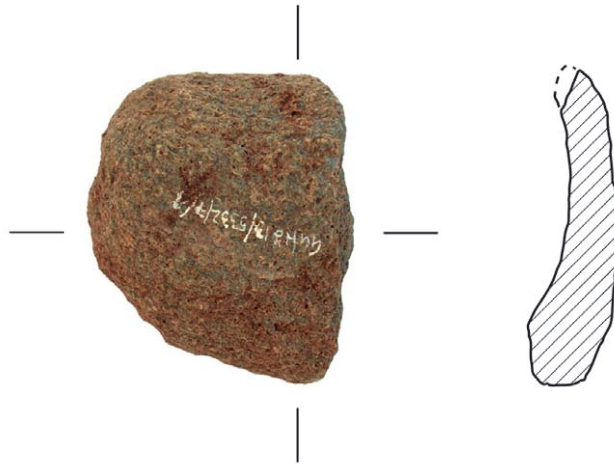

3

ÇuHö Vb SE 5332 (3)
M 1:4

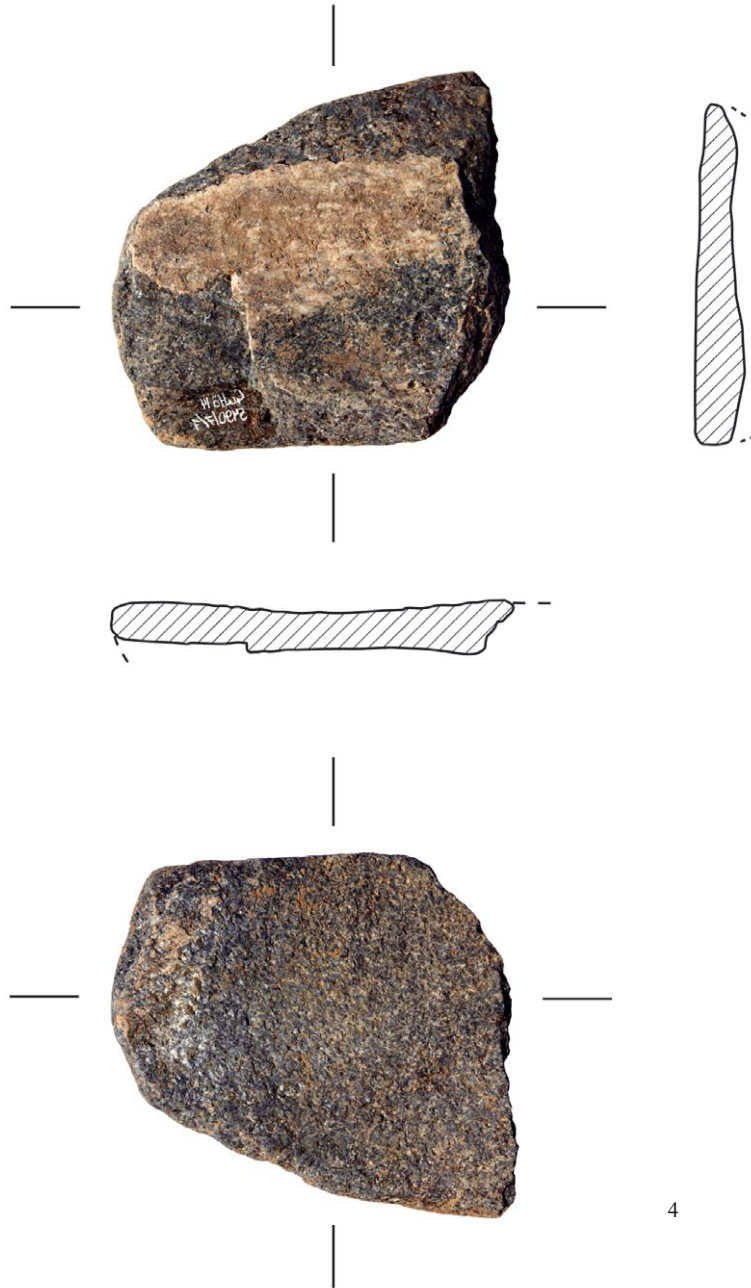

ÇuHö Vb SE 5490 (4)
M 1:4

Tafel 98

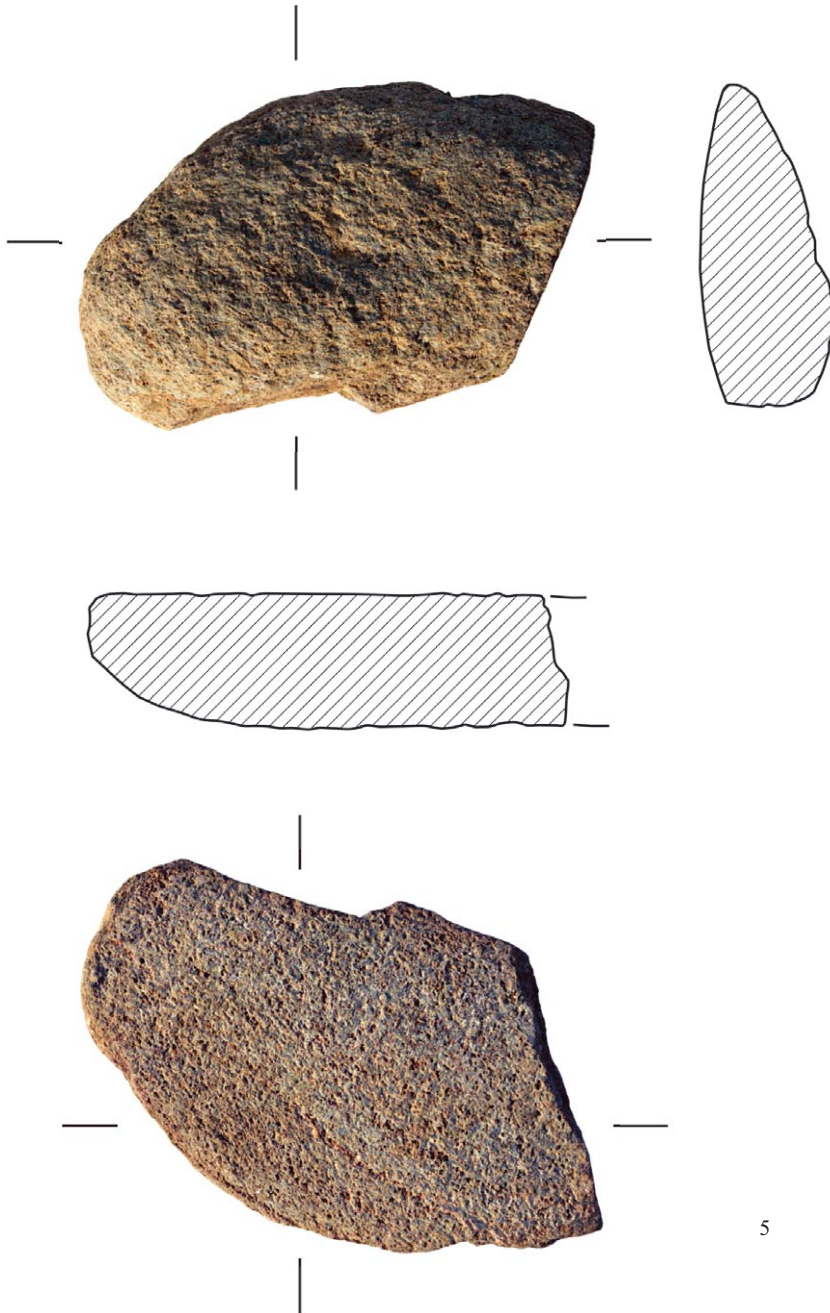

5

Planierung ÇuHö Va/Vb SE 5478 (5)
M 1:6

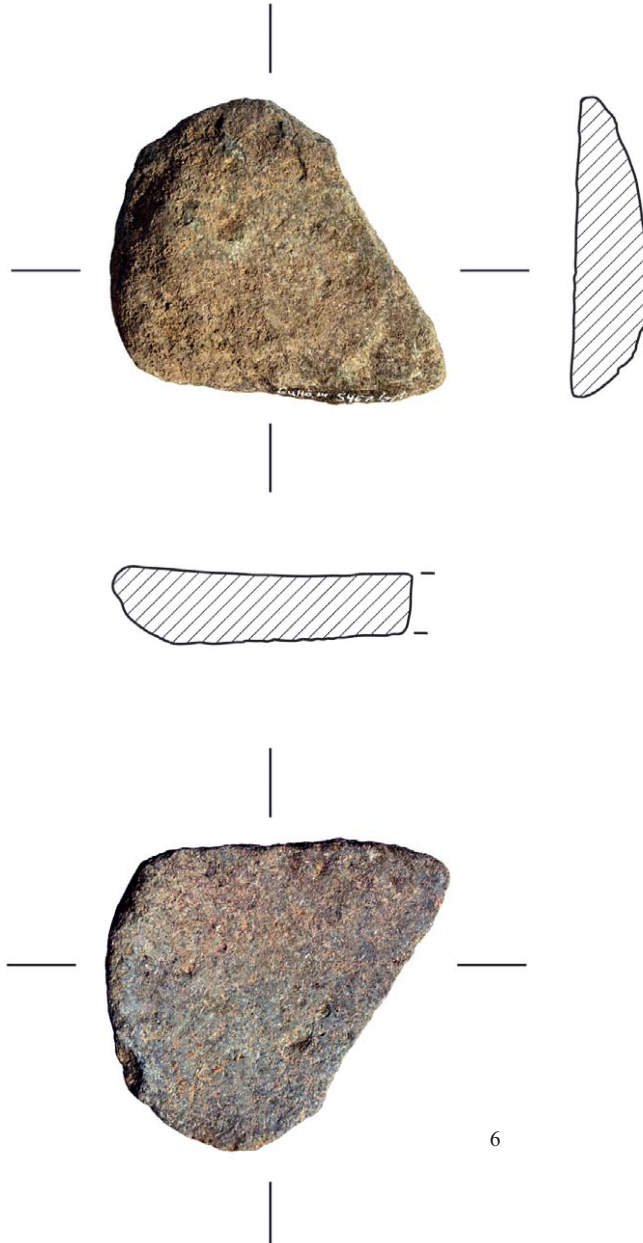

Planierung ÇuHö IV/Vb SE 5467 (6)
M 1:4

Tafel 100

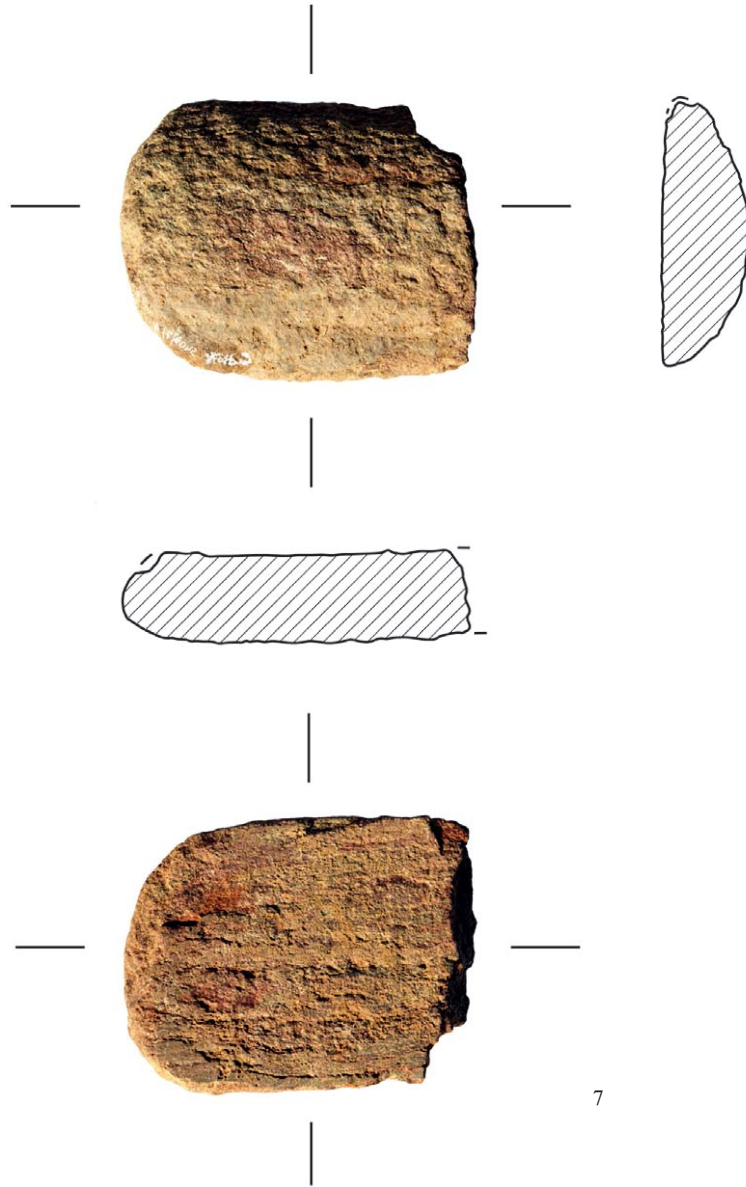

7

Planierung ÇuHö IV/Va SE 5409 (7)
M 1:4



8

Tafel 102

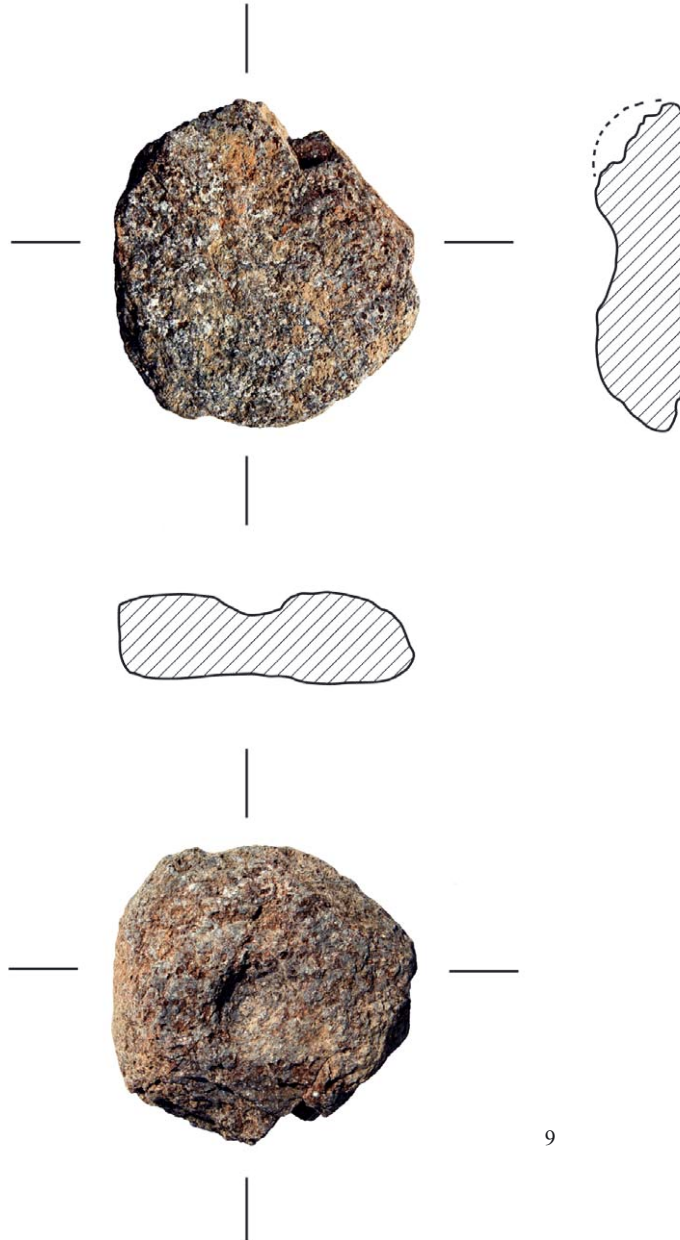

9

Planierung ÇuH6 IV/Va SE 5506 (9)
M 1:4

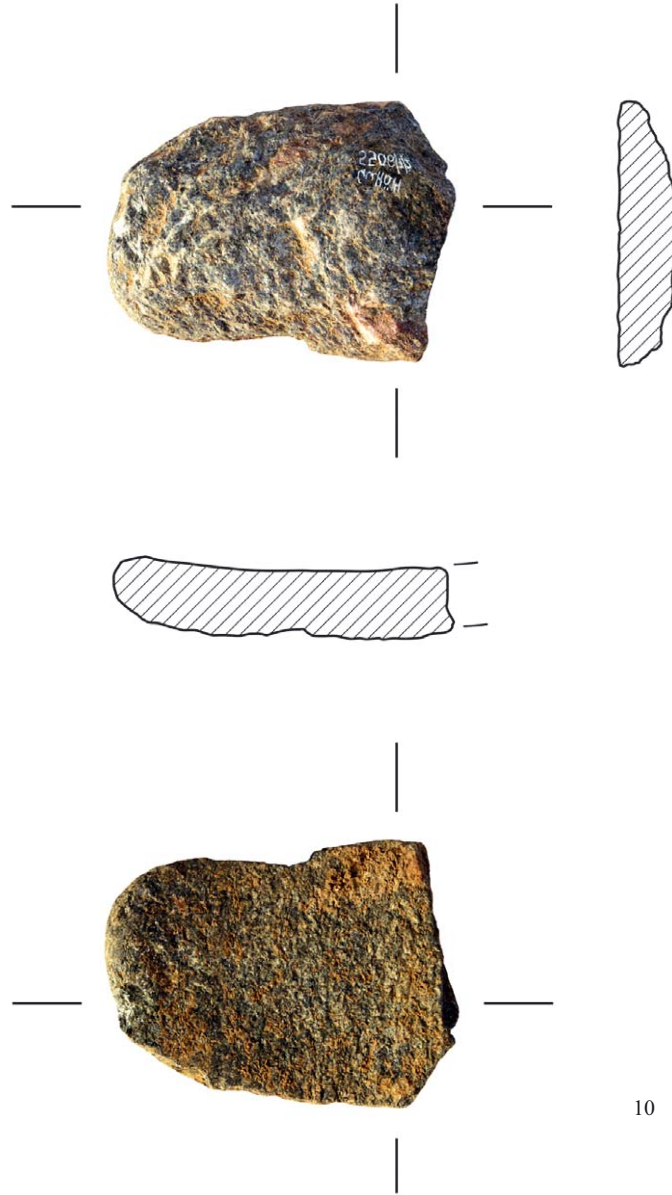

10

