

TAFEL 161

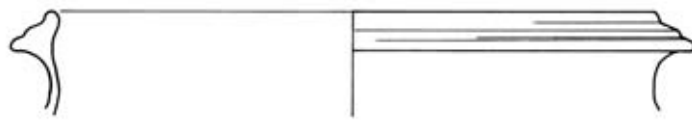

K 233

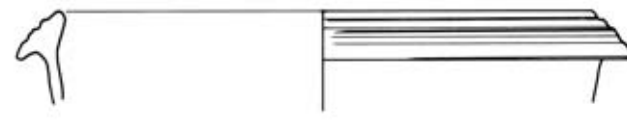

K 234



K 235

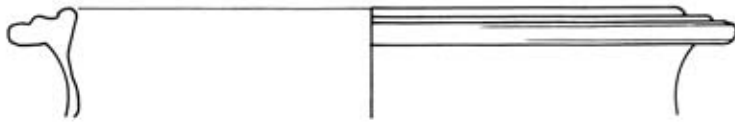

K 237

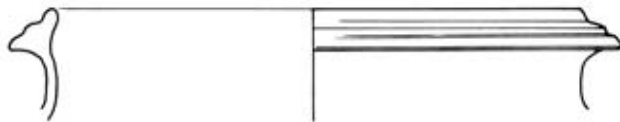

K 238



K 239

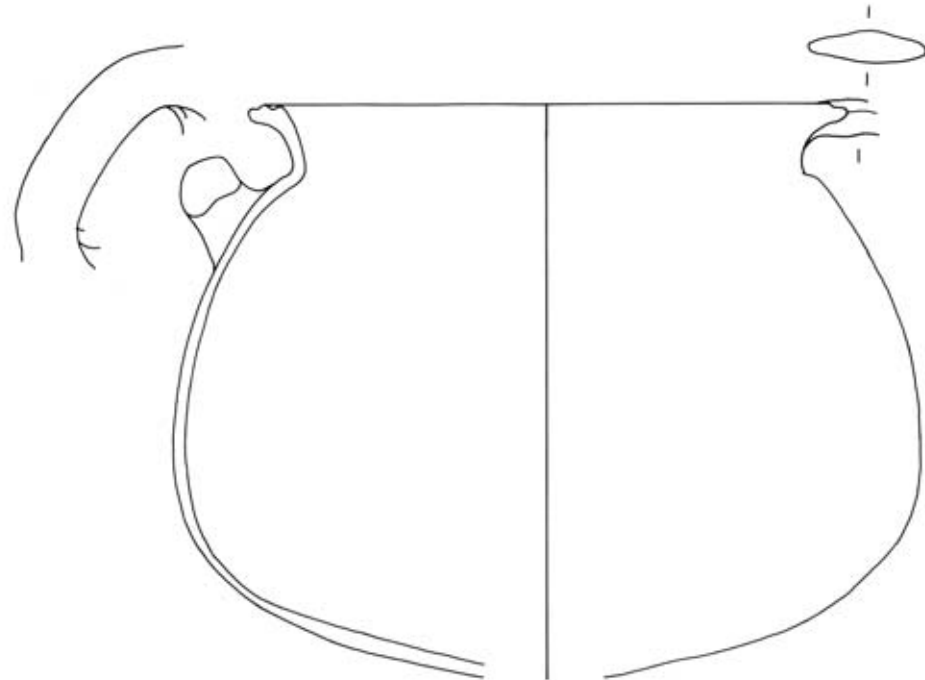

K 236



K 240

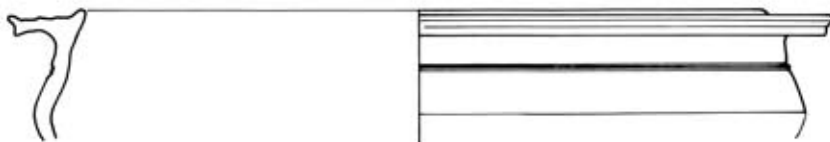

K 241

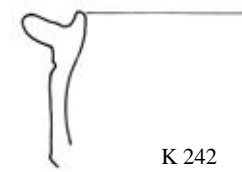

K 242

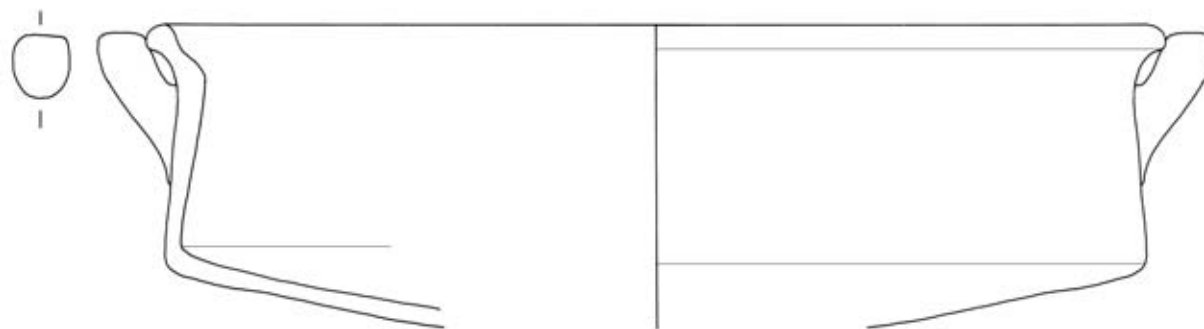

K 243

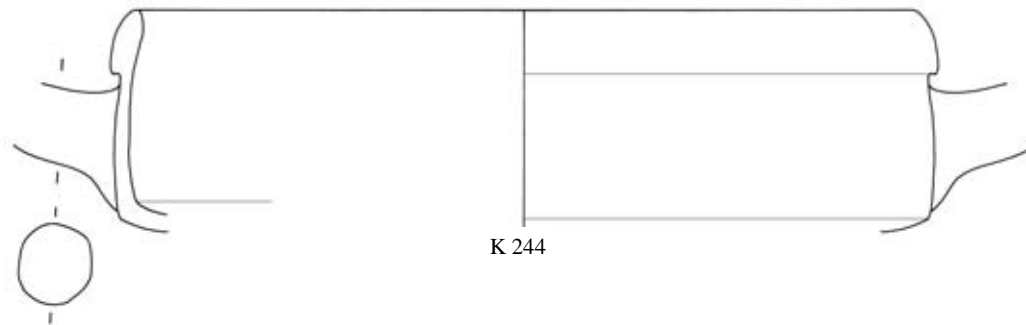

K 244

BI/1

TAFEL 162

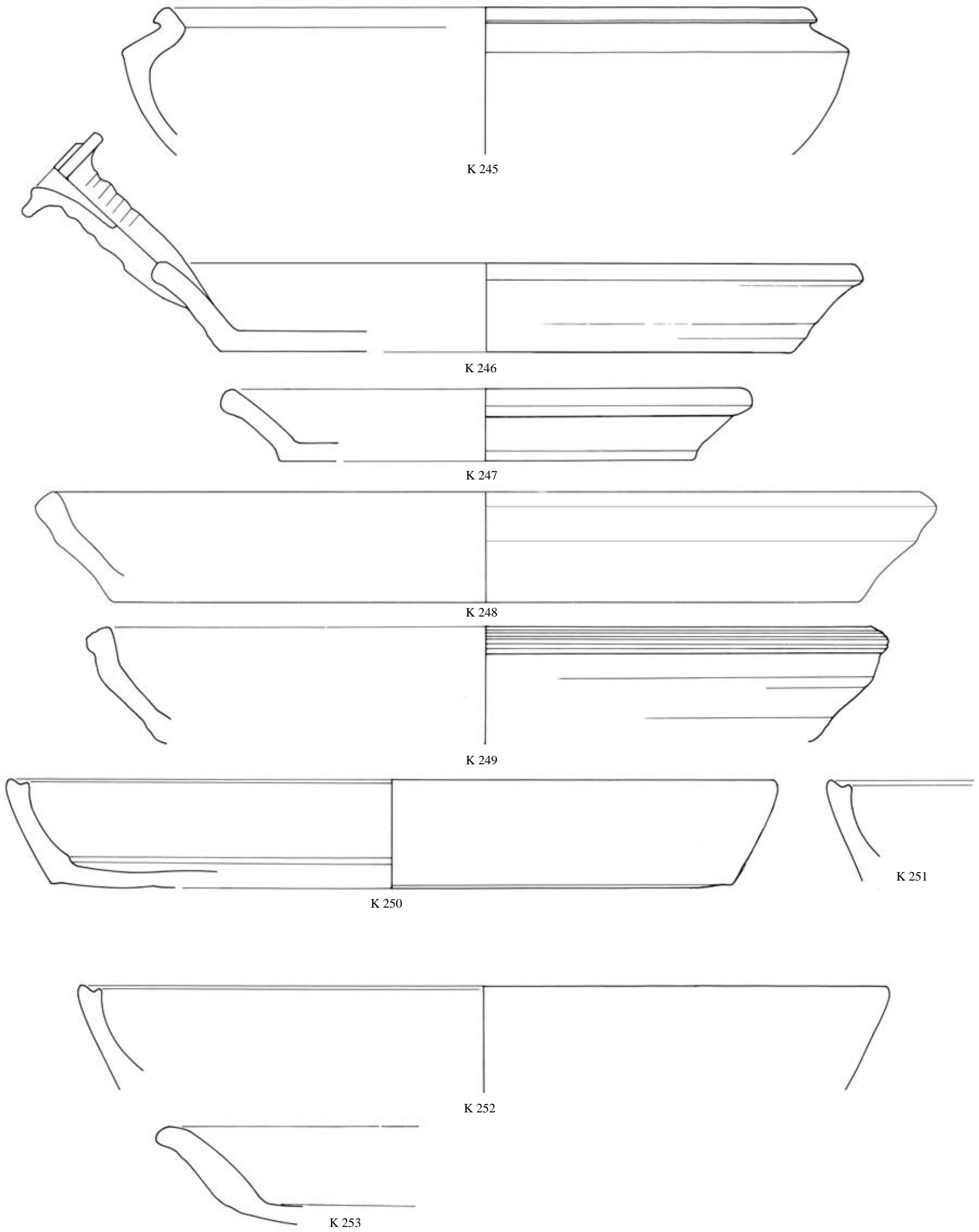

TAFEL 163

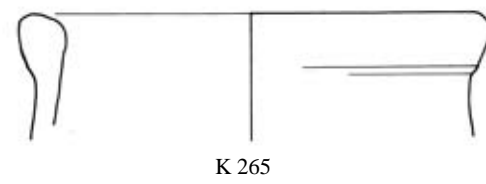
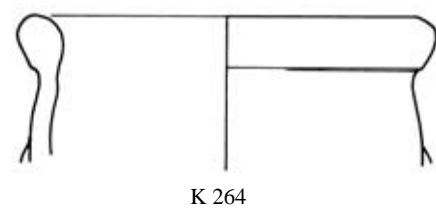
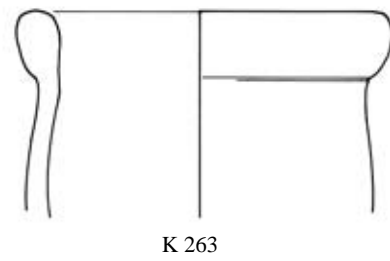
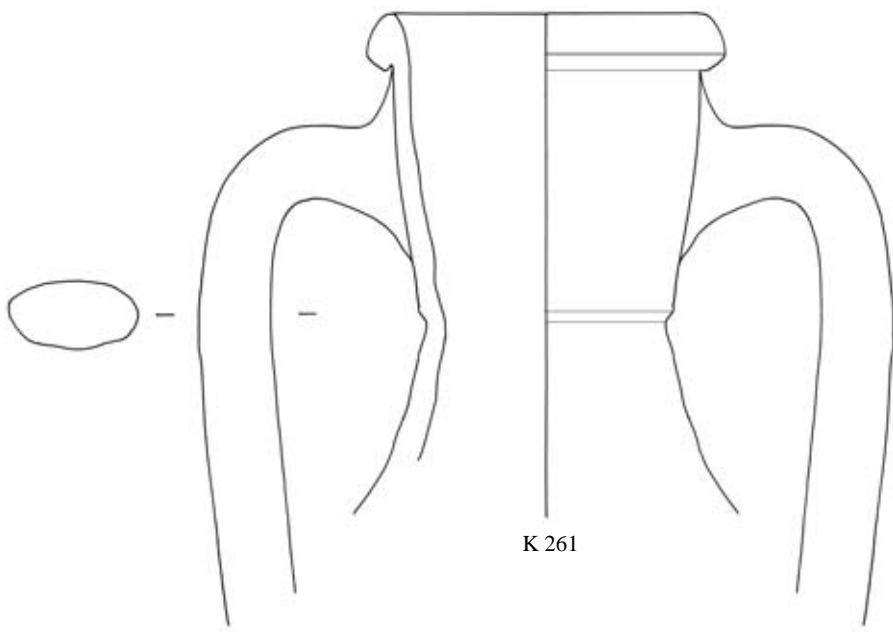
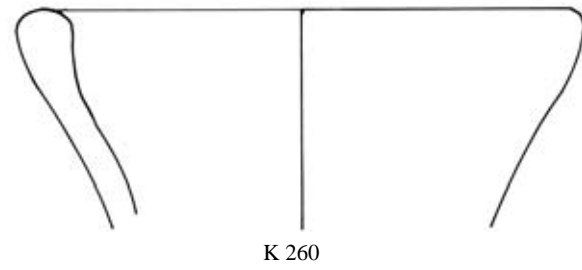
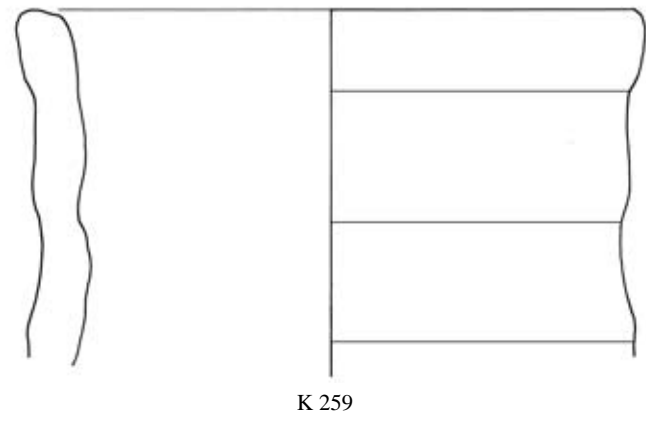
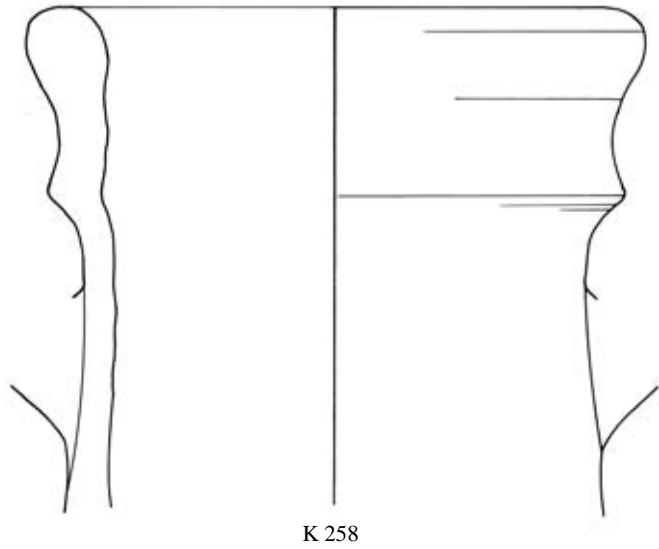
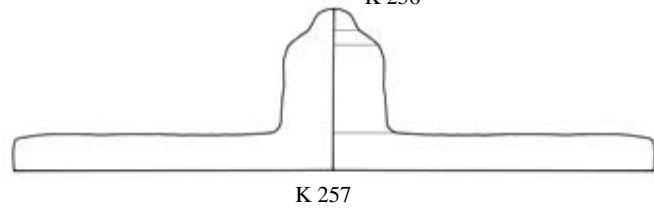
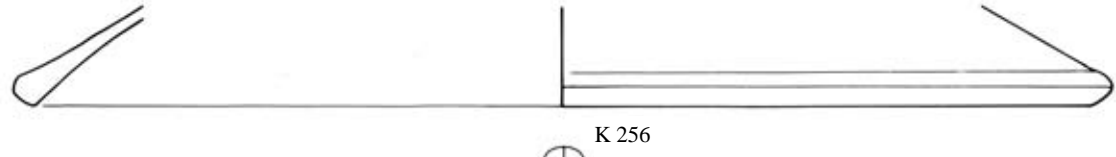
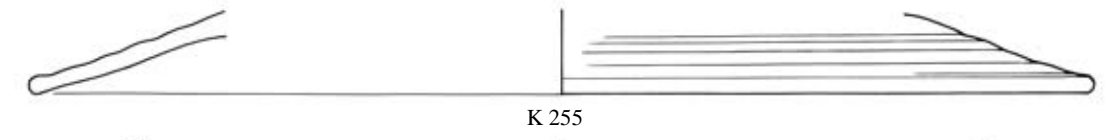
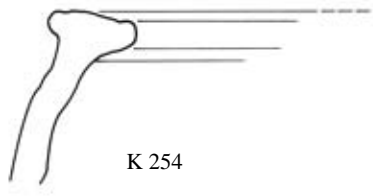

TAFEL 164

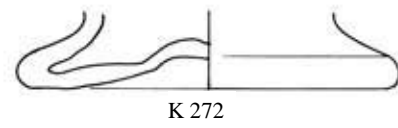
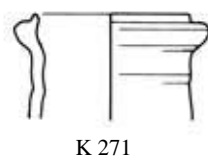
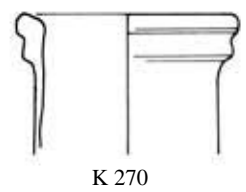
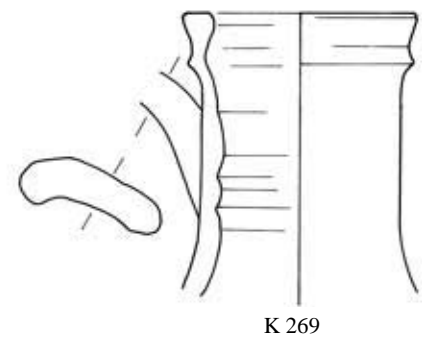
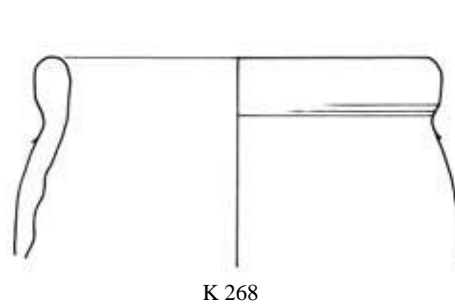
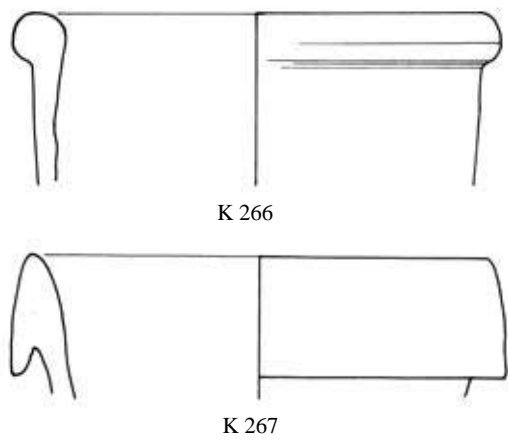
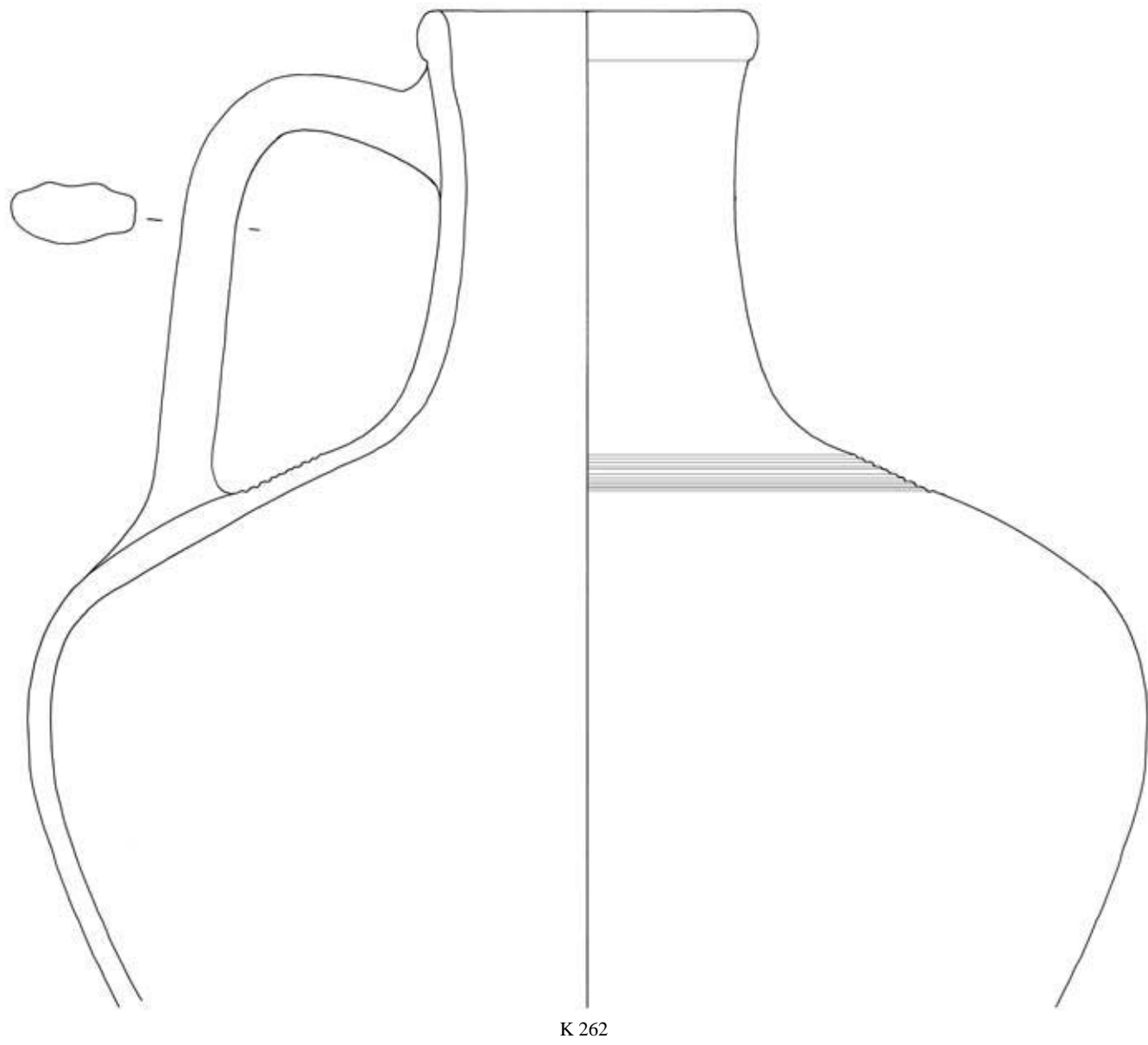

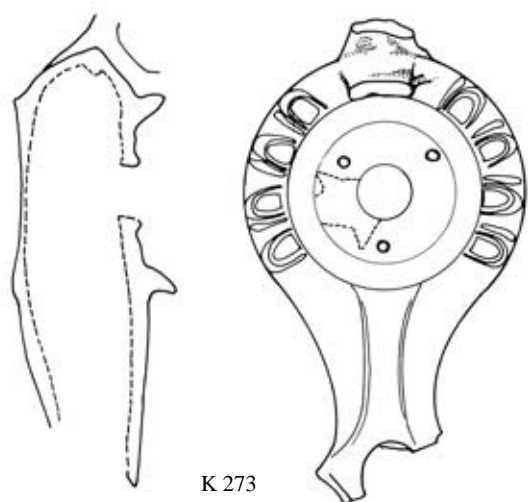

K 273

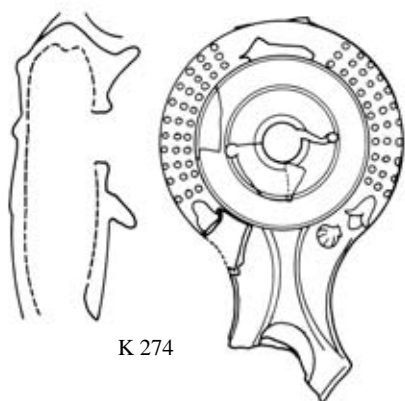

K 274

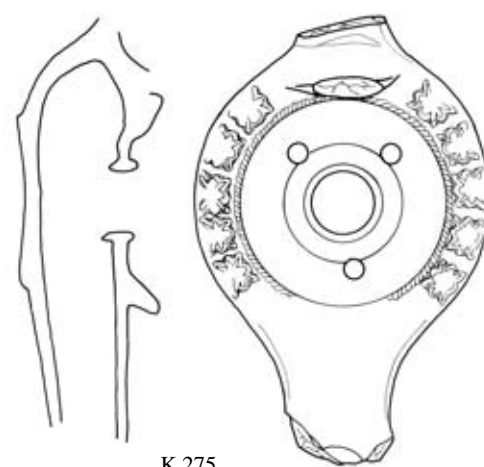

K 275



K 276



K 277

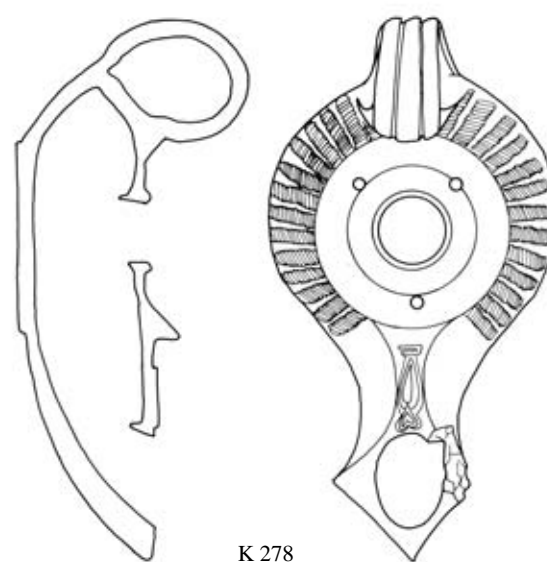

K 278

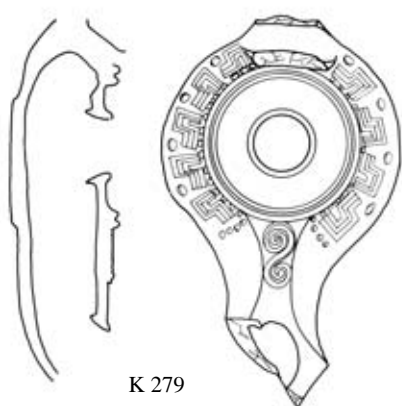

K 279

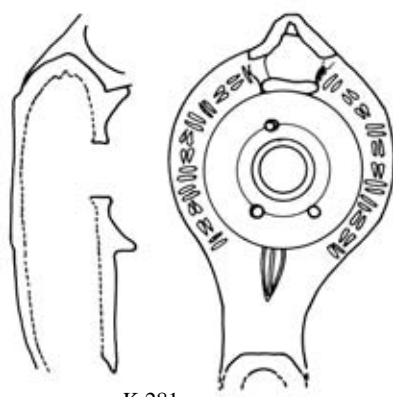

K 281

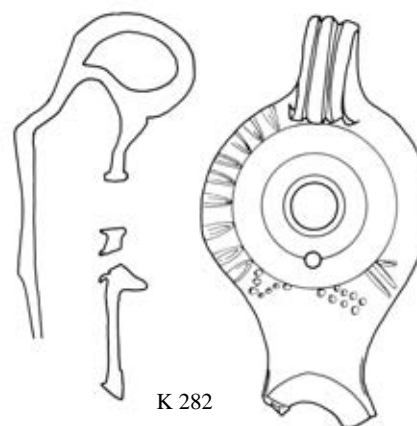

K 282

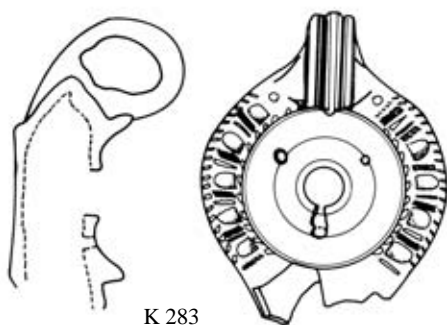

K 283

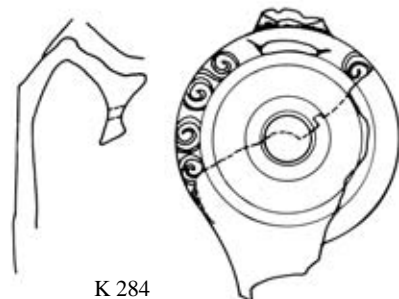

K 284

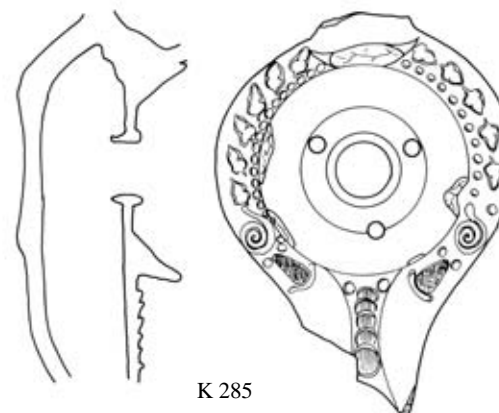

K 285

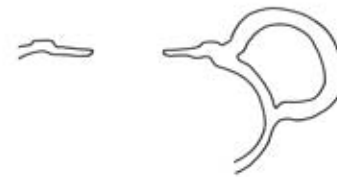
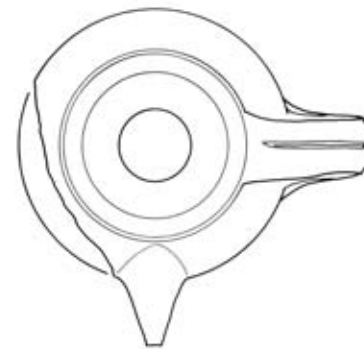
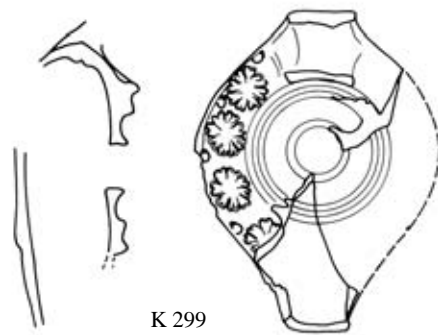
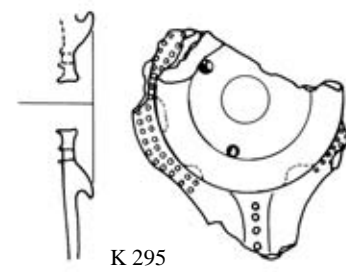
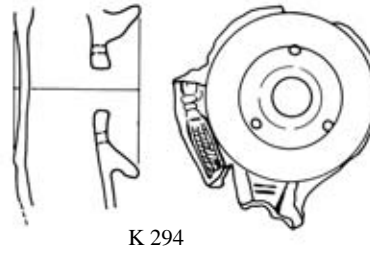
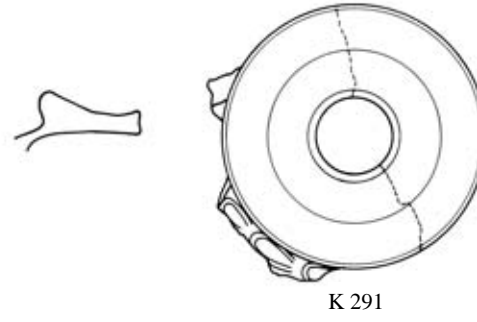
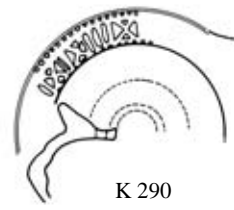
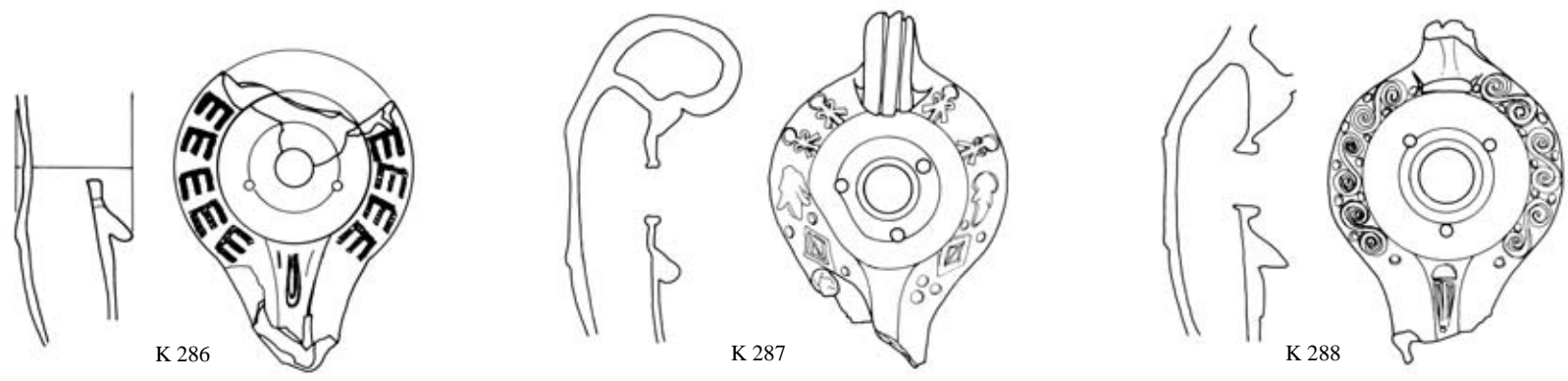

BI/1

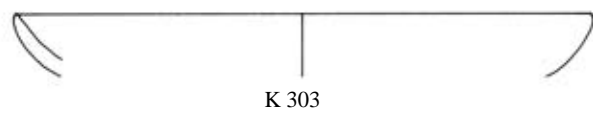

TAFEL 167

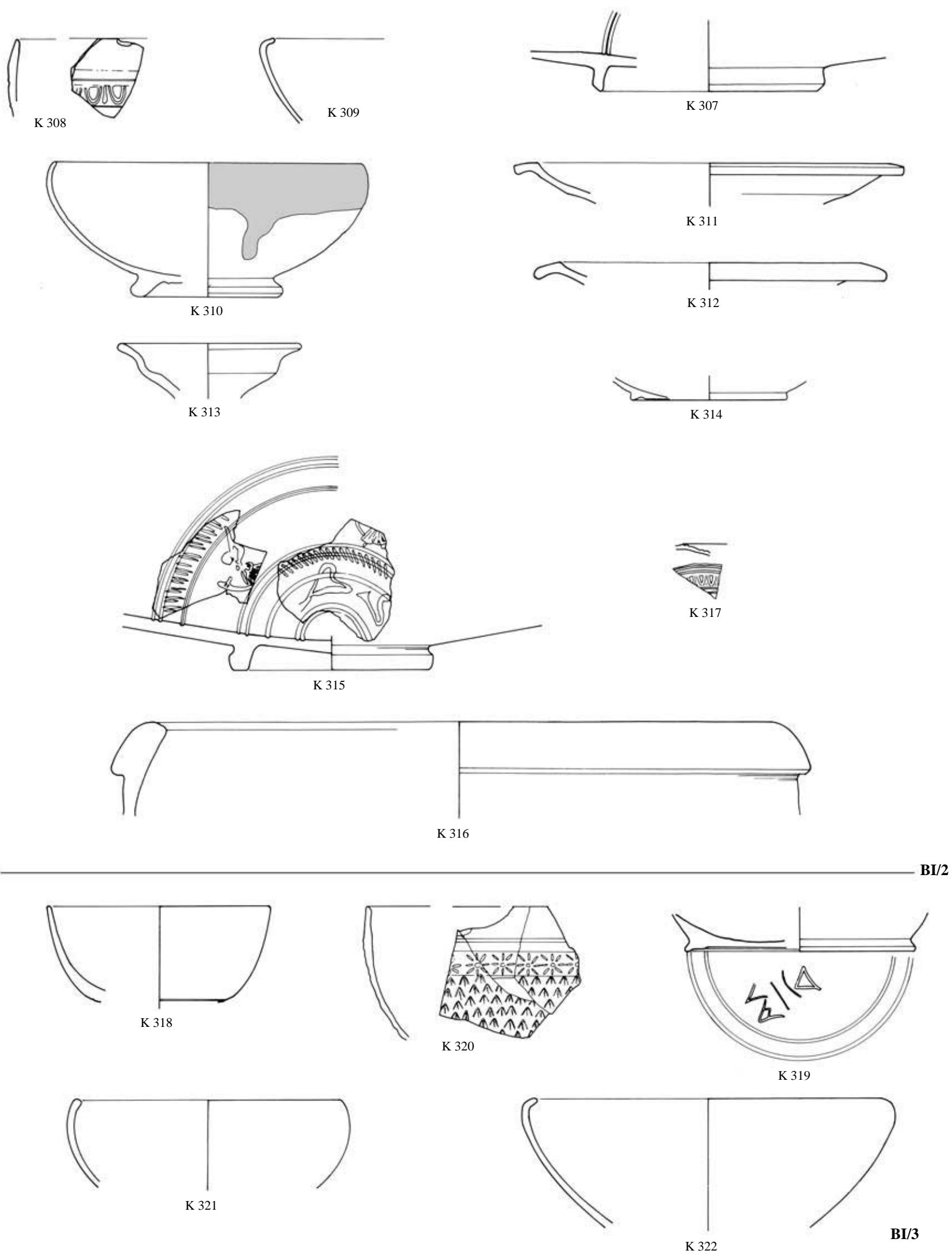

TAFEL 168

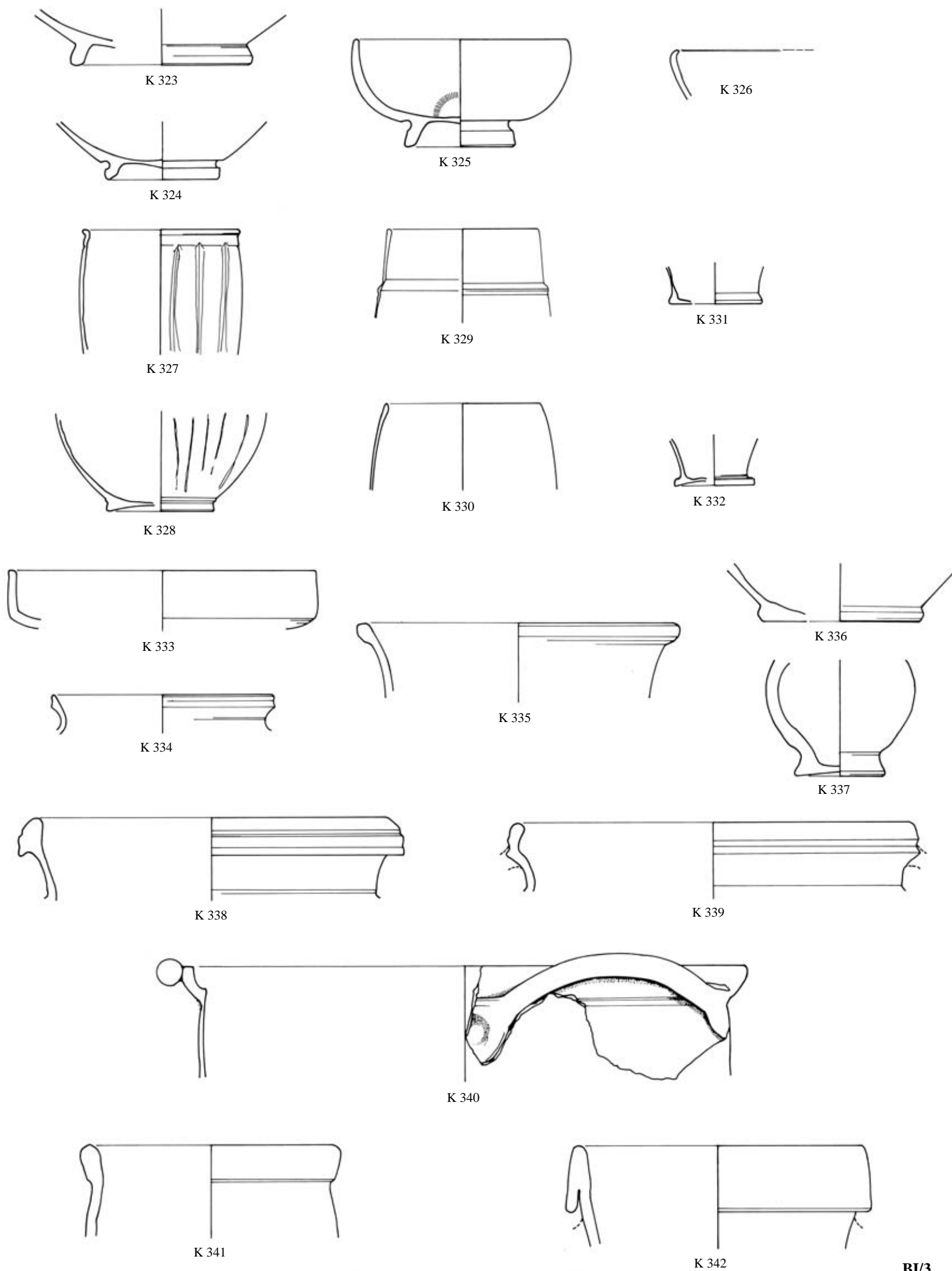



TAFEL 169

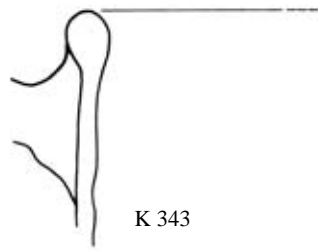

K 343

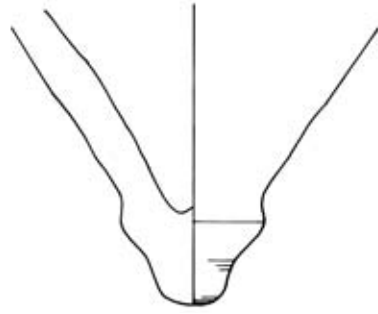

K 344

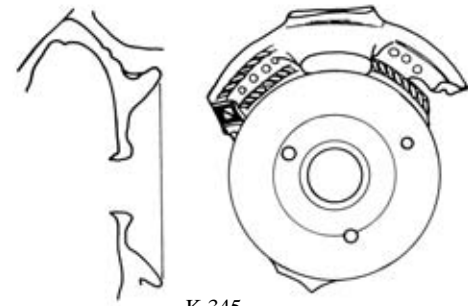

K 345

BI/3

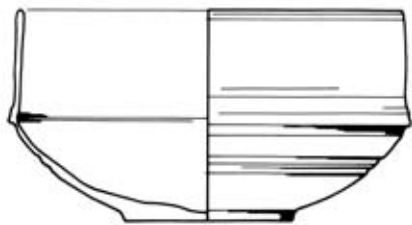

K 346

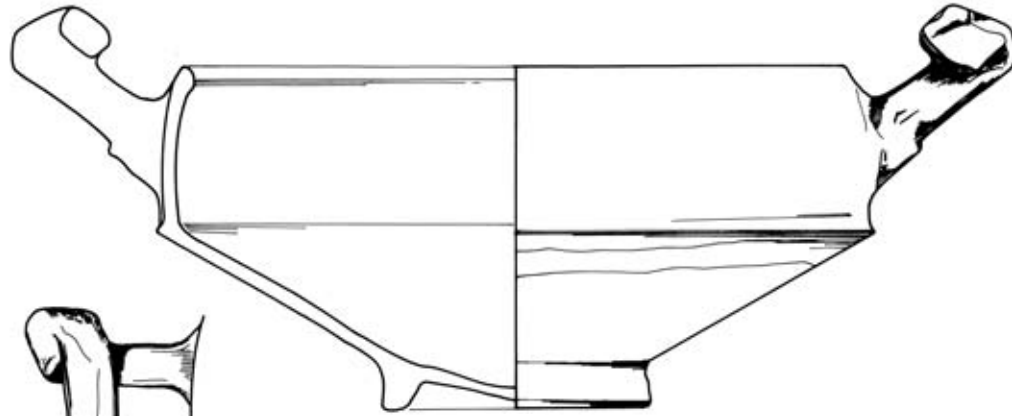

K 348



K 347

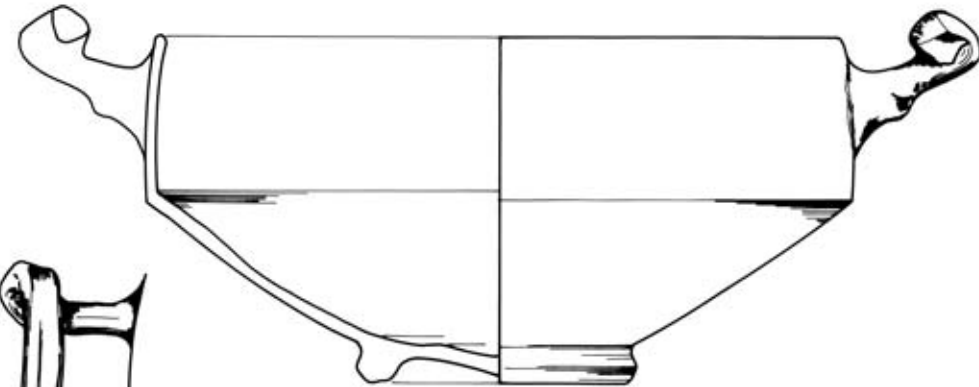

K 349

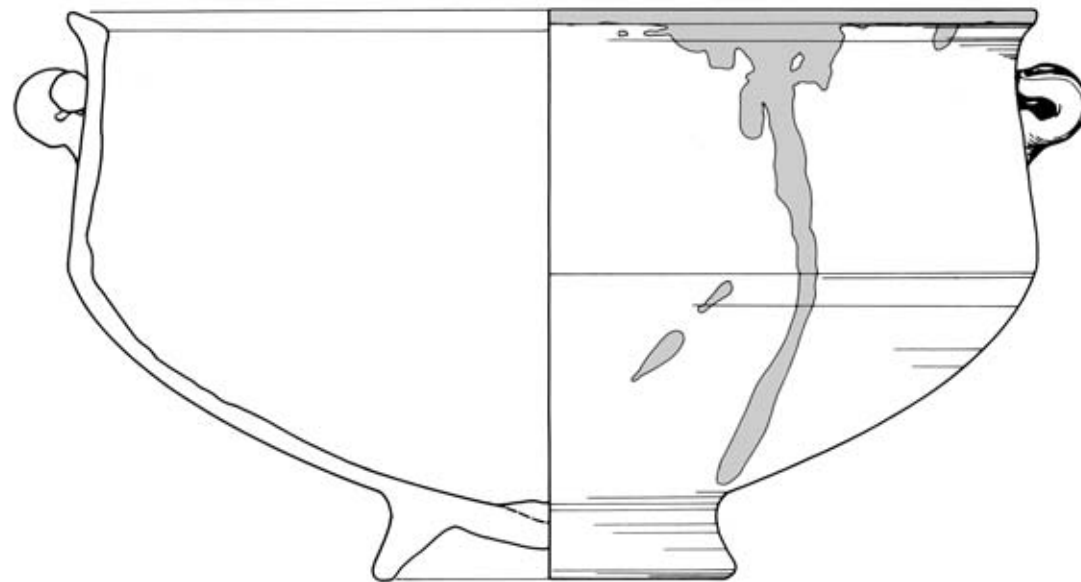

K 350



BI/1

0 10 cm

TAFEL 170

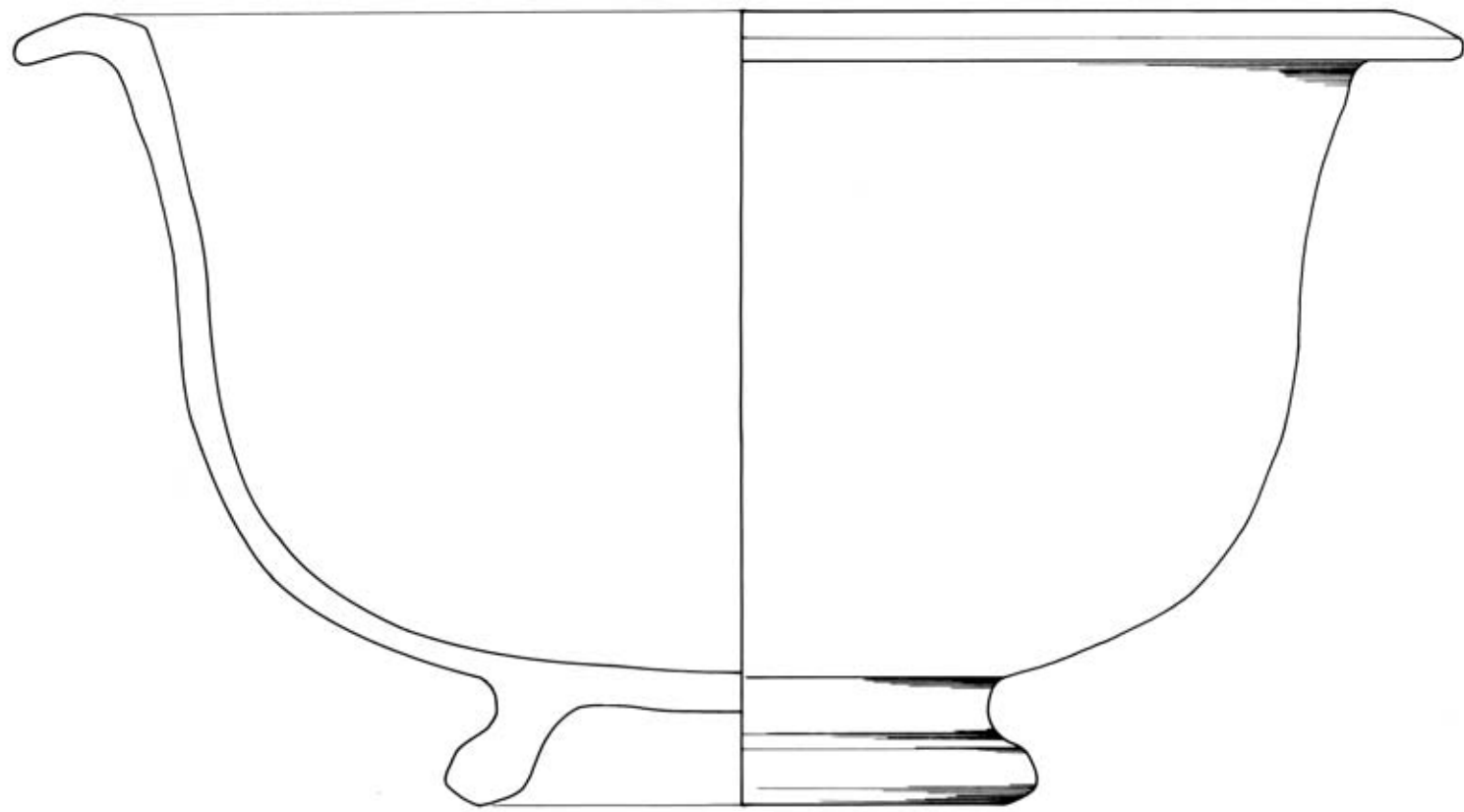

K 351

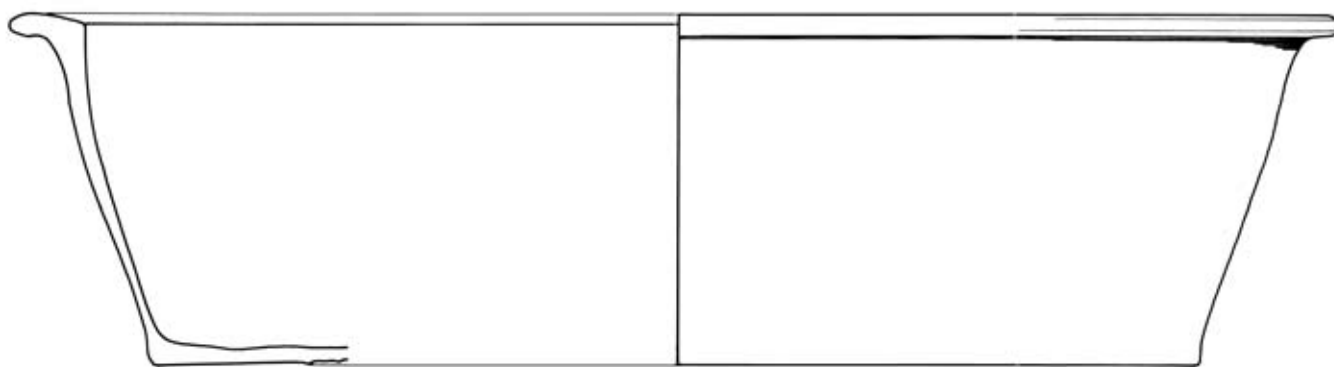

K 352

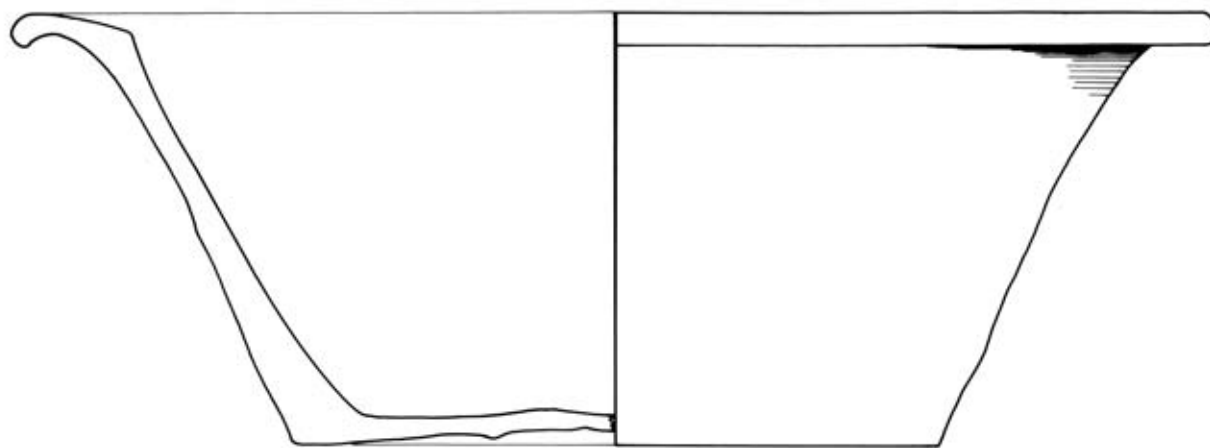

K 353

BI'/1



K 354

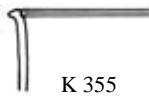

K 355

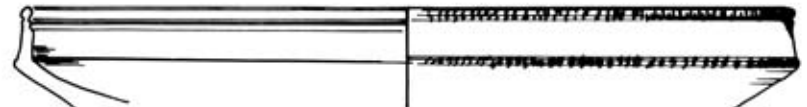

K 356



K 357

BI'/2

0 10 cm

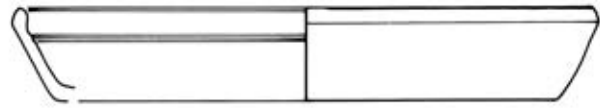

K 358

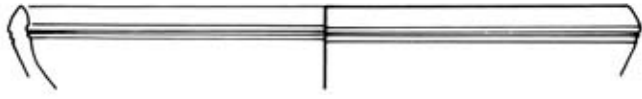

K 359

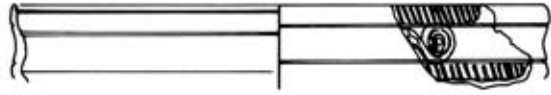

K 360



K 362



K 363

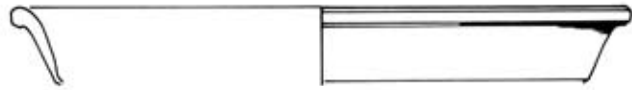

K 365

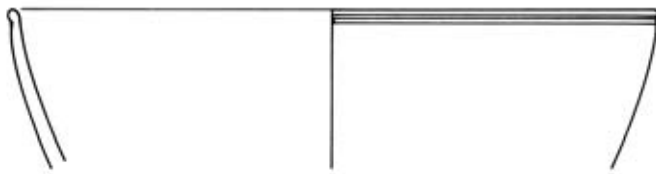

K 367

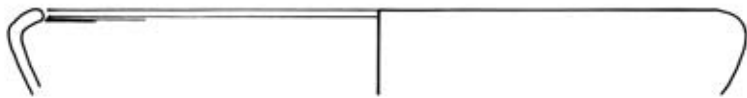

K 369

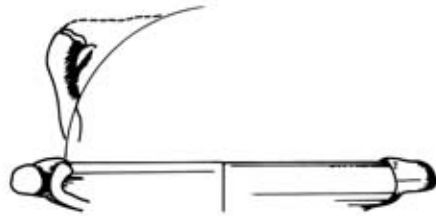

K 371

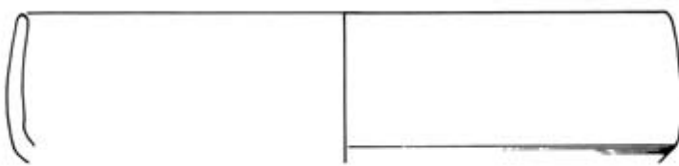

K 373



K 376

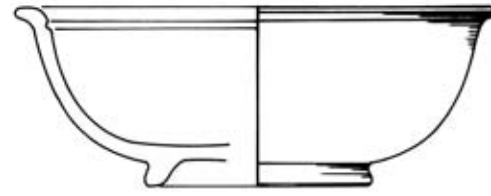

K 361

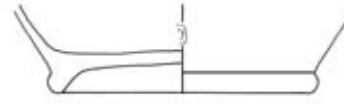

K 364

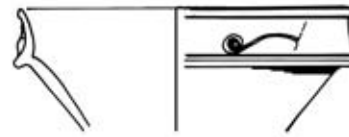

K 366

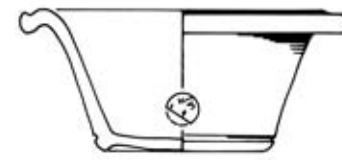

K 368



K 370



K 372

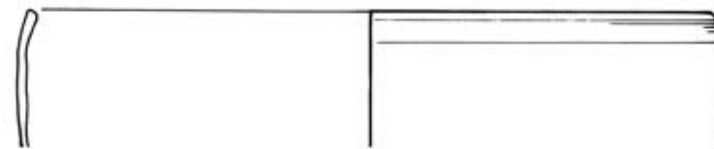

K 374

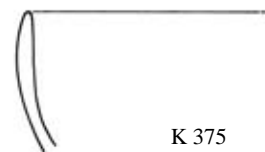

K 375

BI'/2