

TAFEL 182

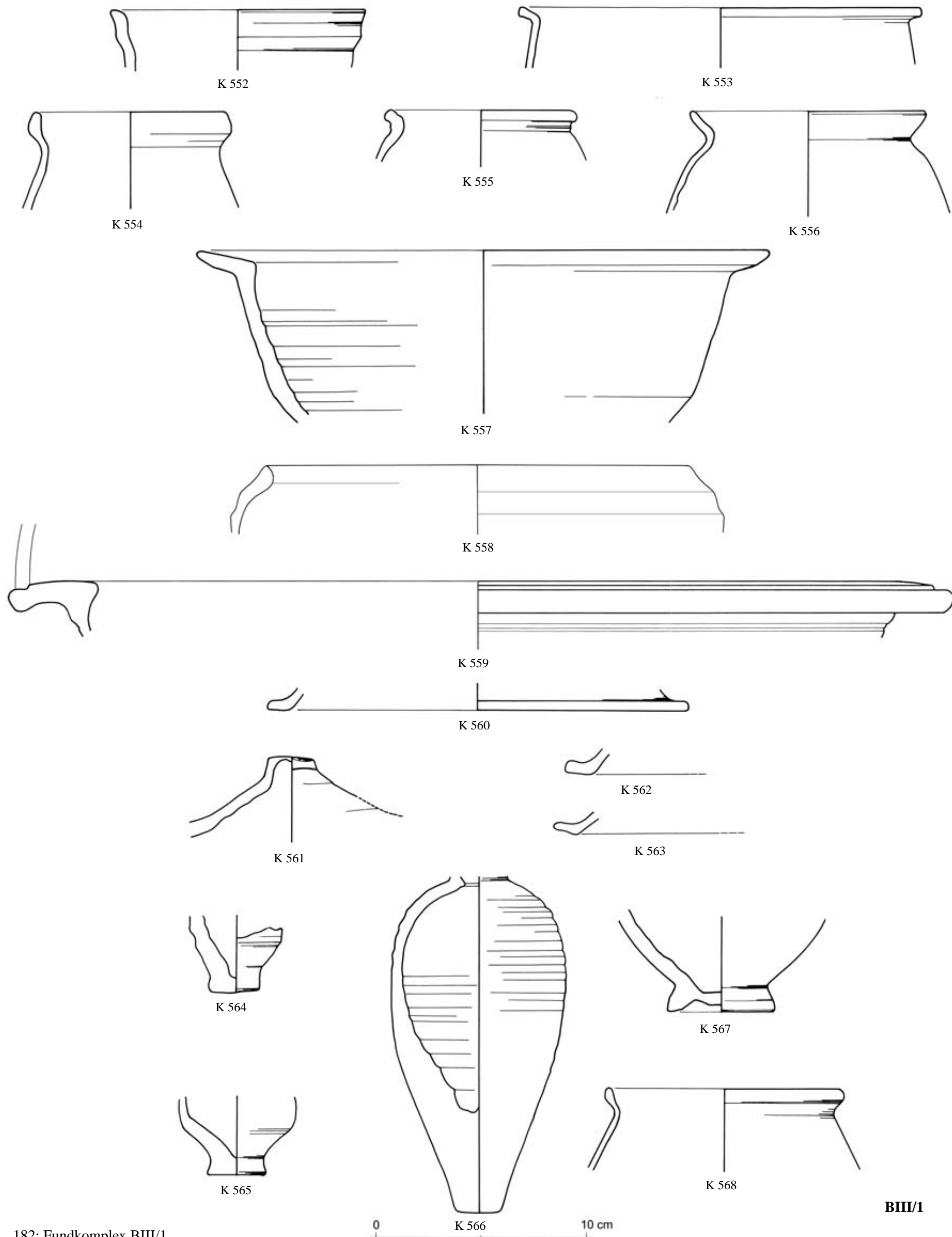

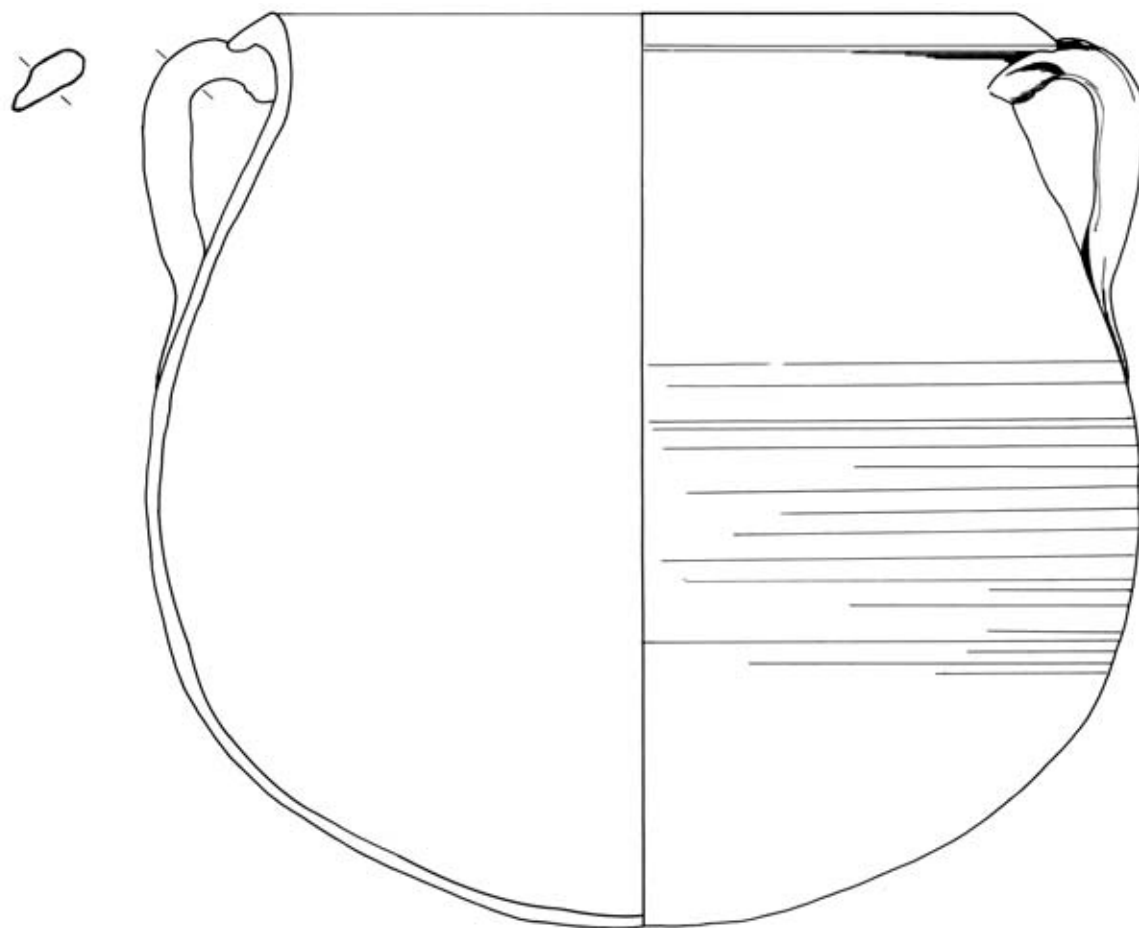

K 569

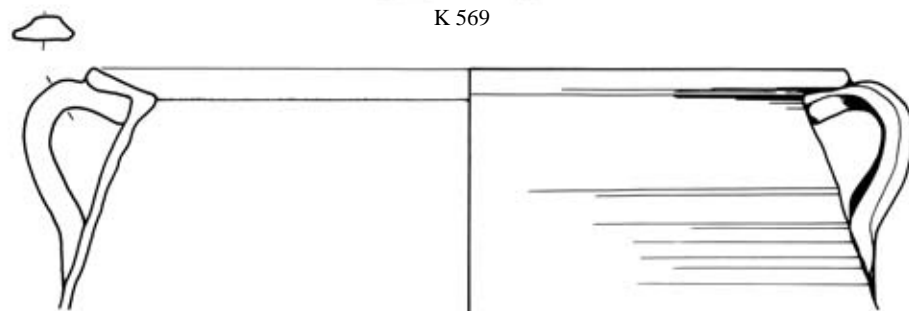

K 570

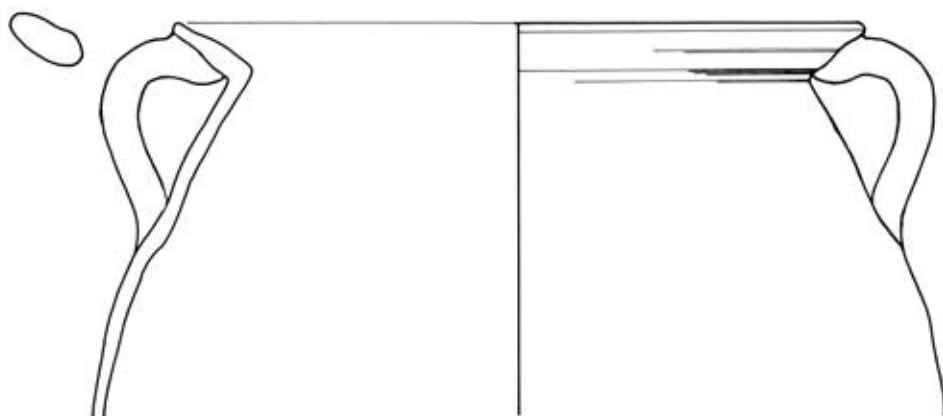

K 571

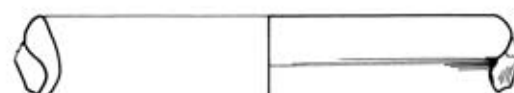

K 572

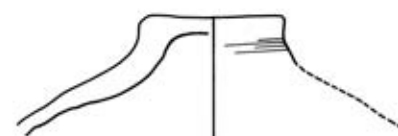

K 573



K 574

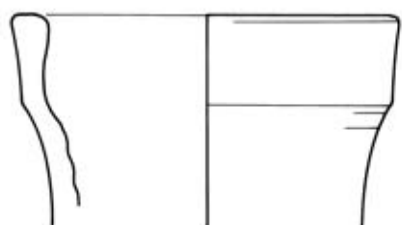

K 575

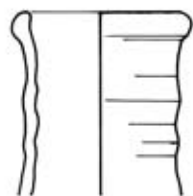

K 576



K 577



K 578



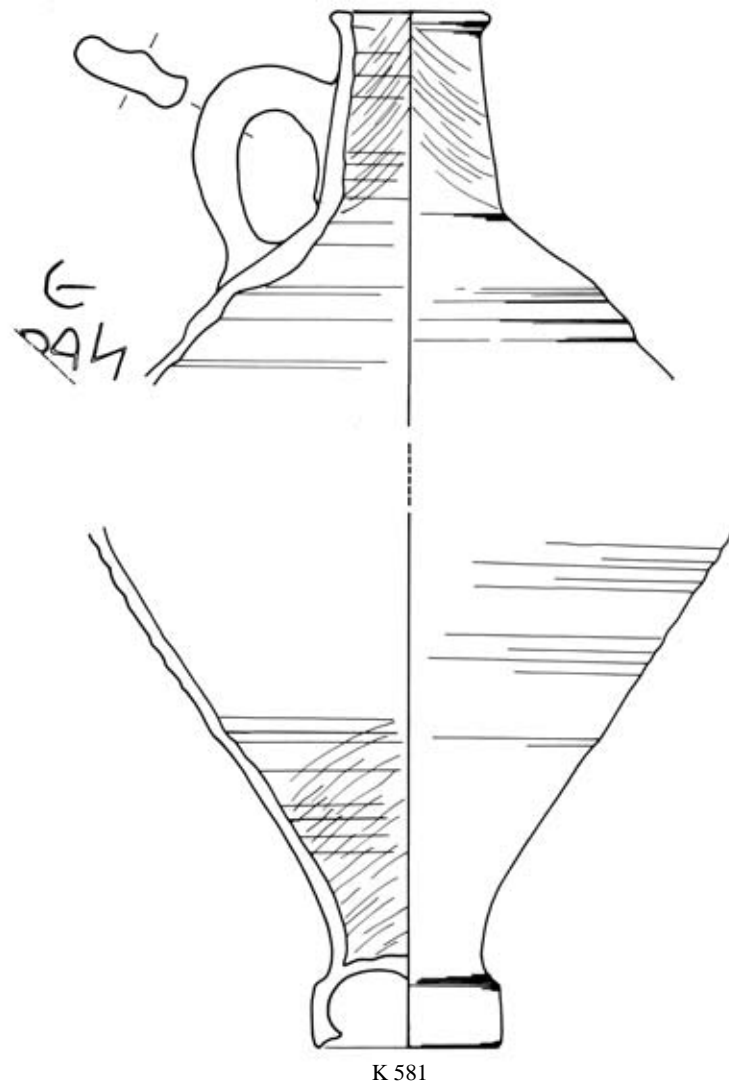
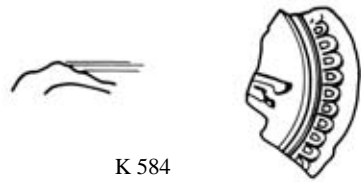
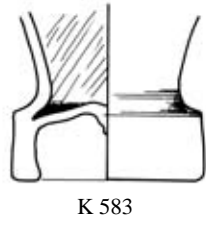
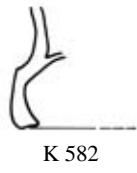
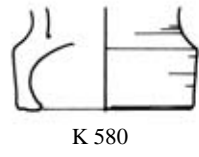
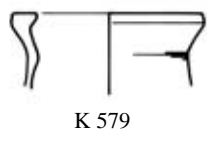

BIII/1

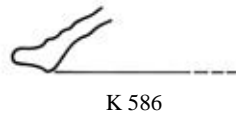
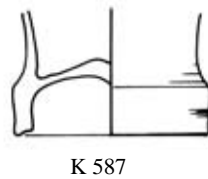
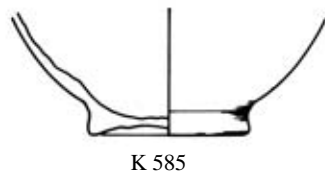

BIII/2

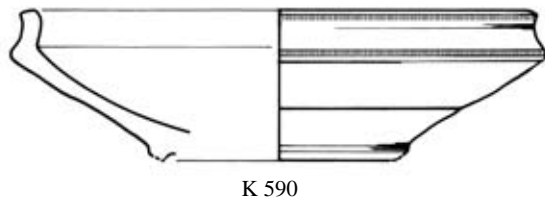
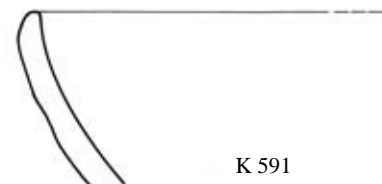

BIV/1

TAFEL 185

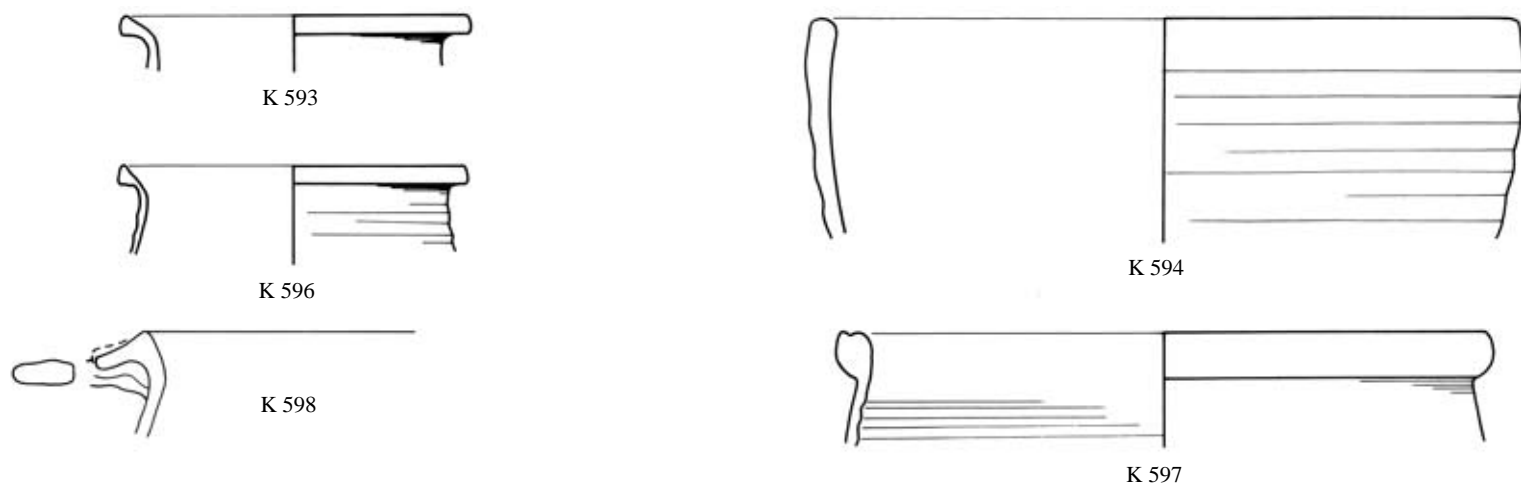

BIV/1

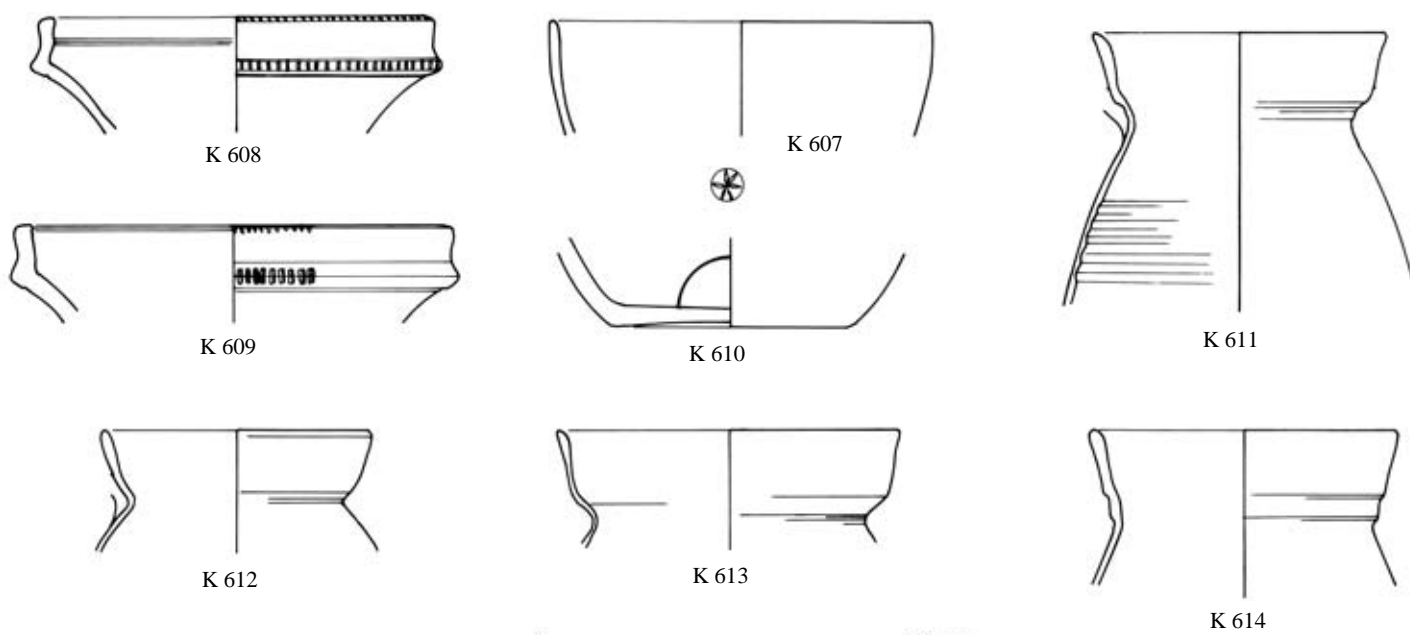
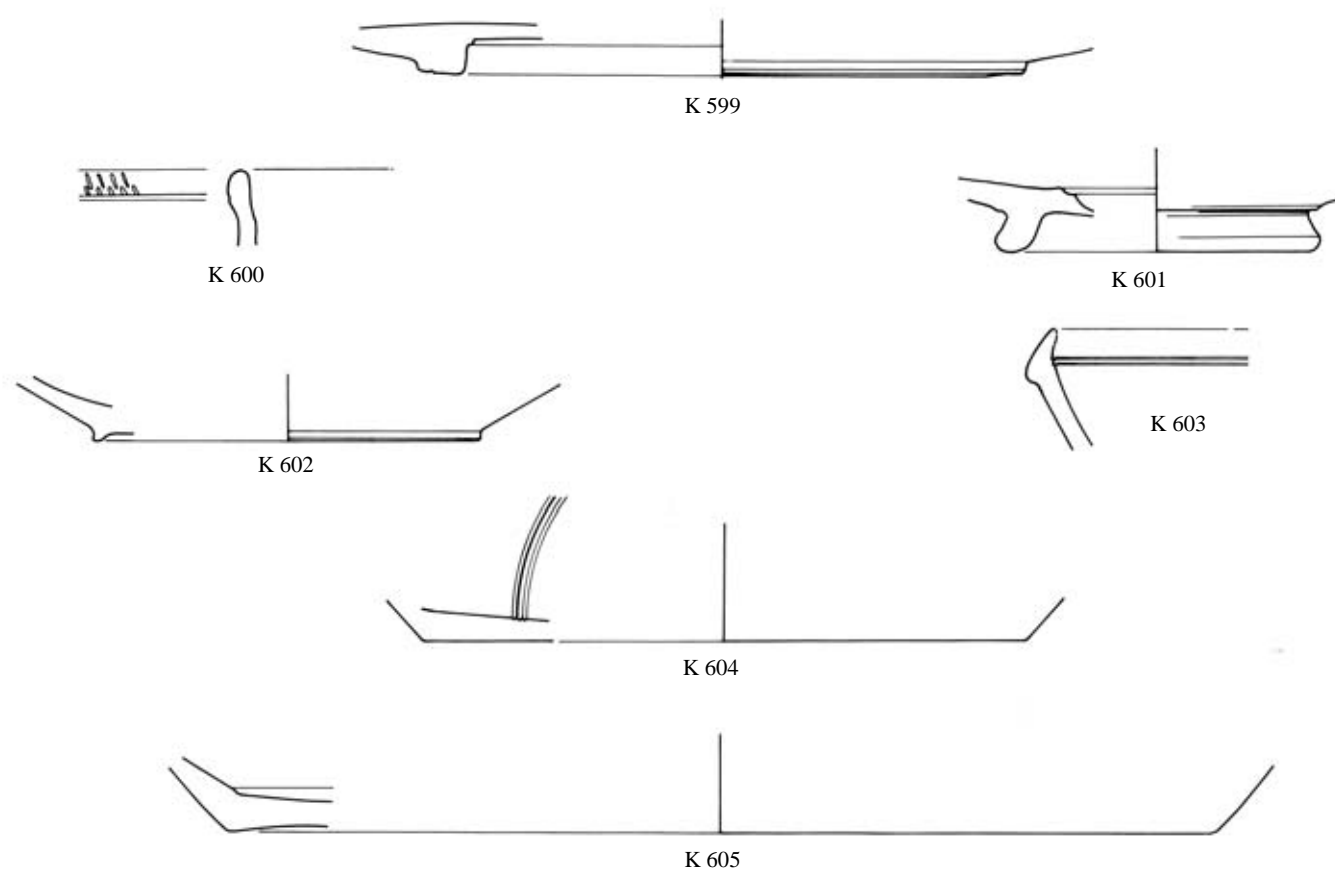

185: Fundkomplexe BIV/1–BIV/2



BIV/2

TAFEL 186

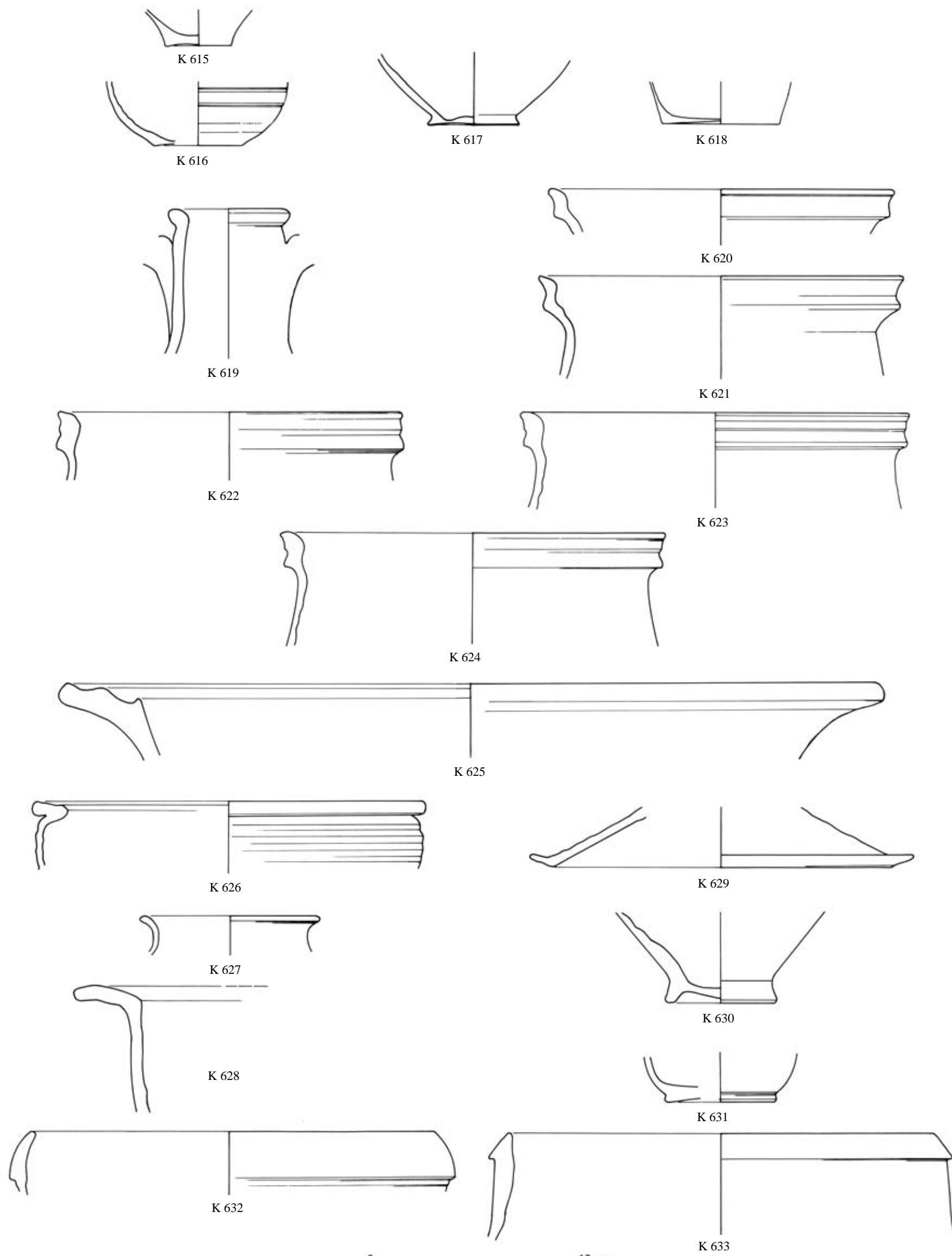

TAFEL 187

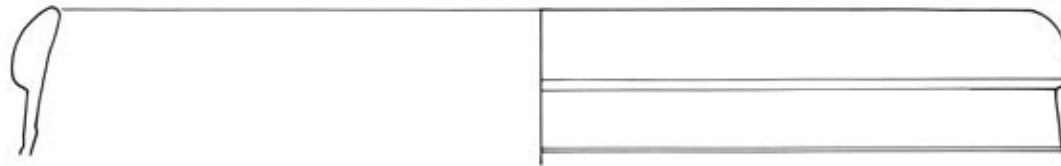

K 634

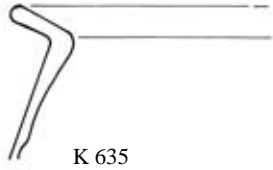

K 635

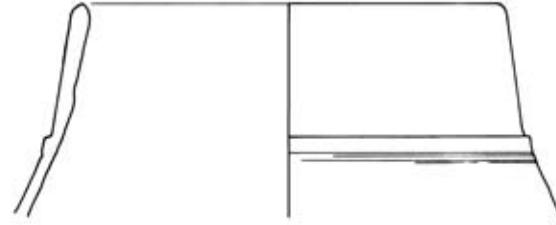

K 636

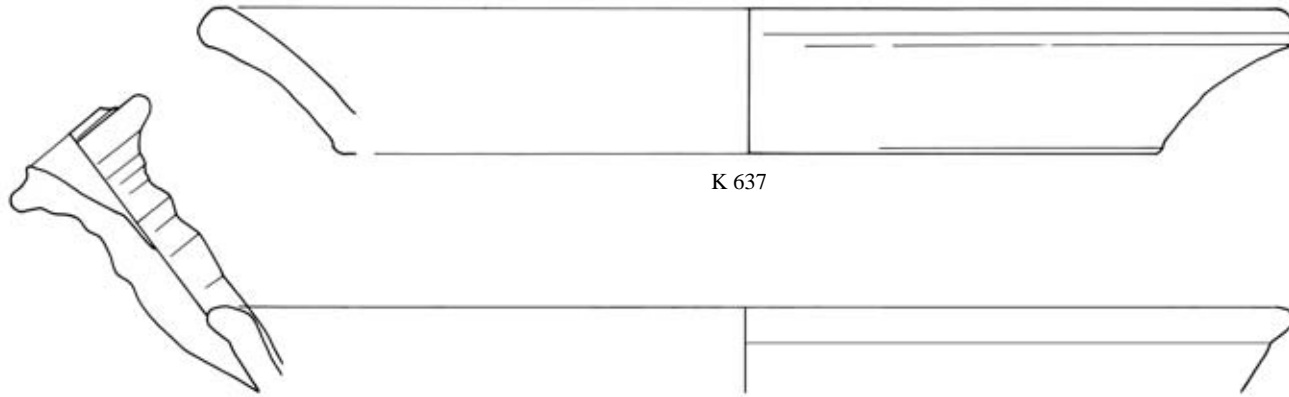

K 637



K 638

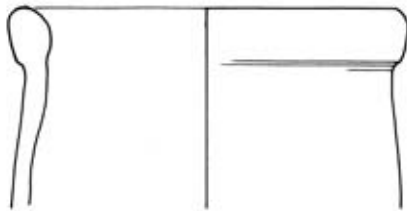

K 641



K 640

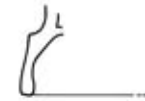

K 643



K 642



K 644

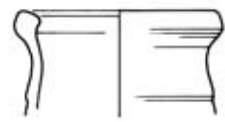

K 645

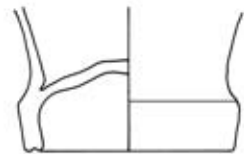

K 646

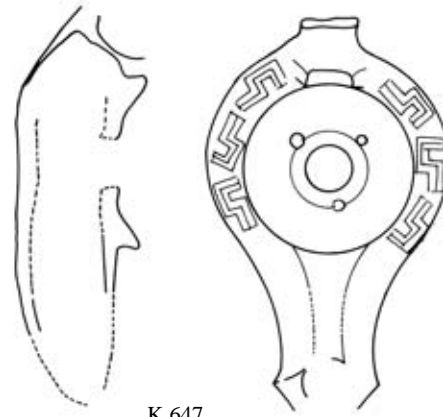

K 647

BIV/2

TAFEL 188

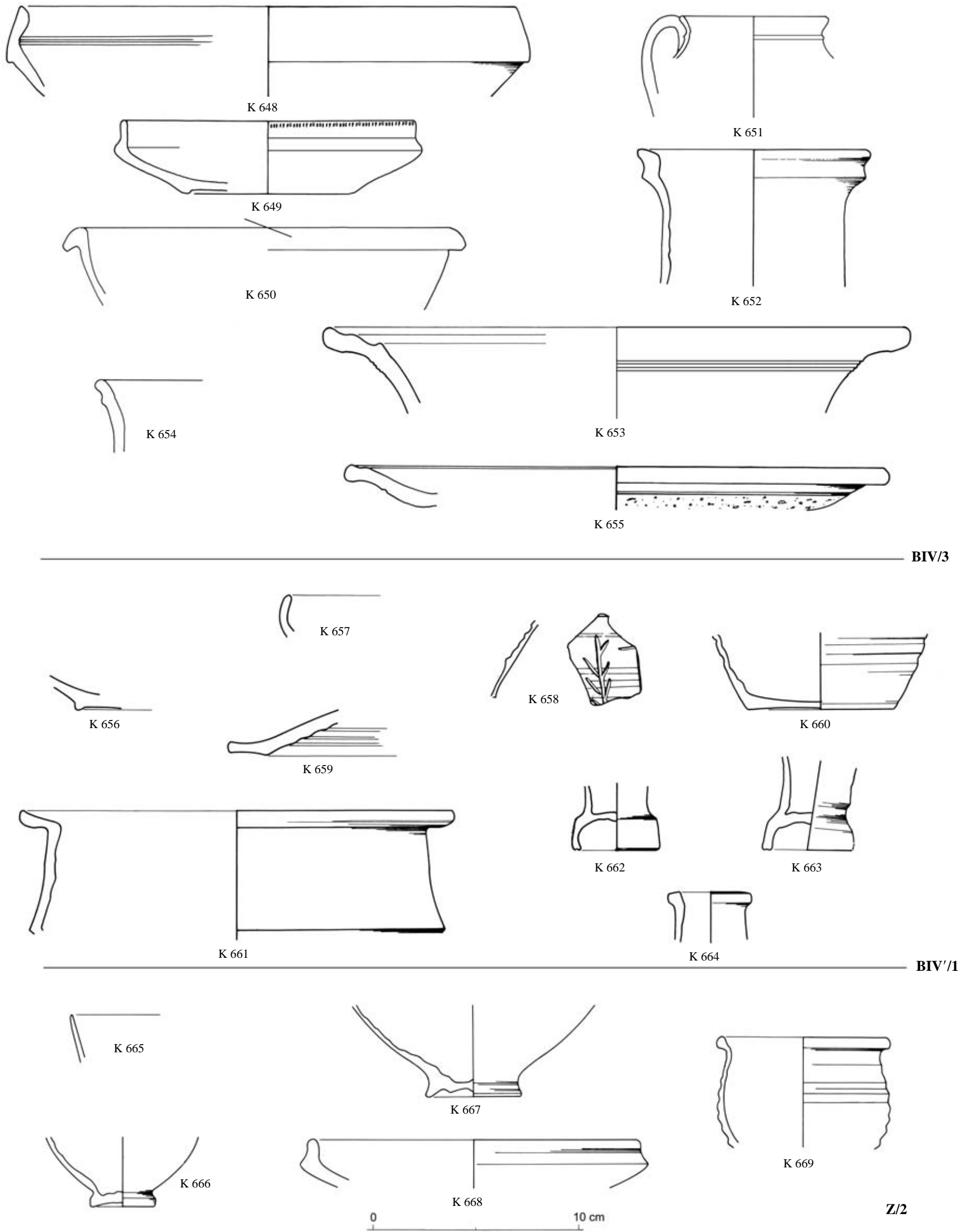

TAFEL 189

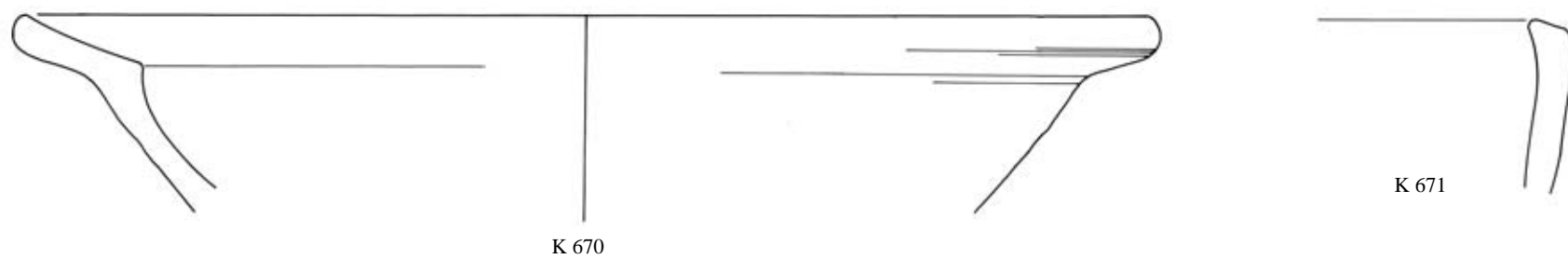

Z/2

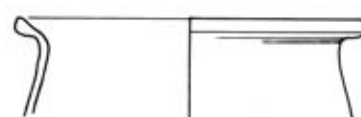
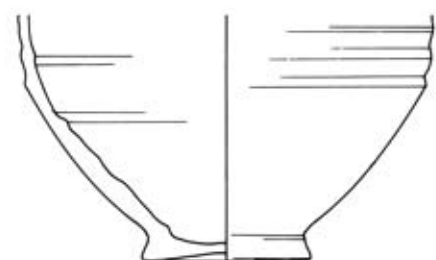
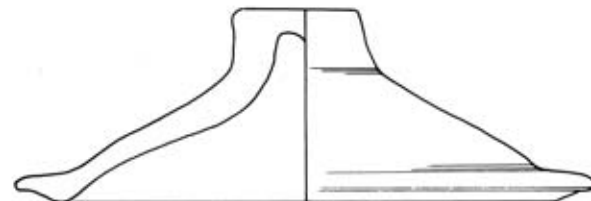
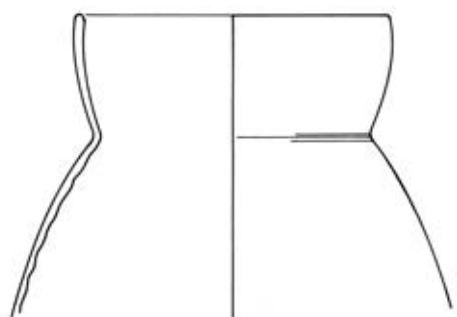

K 673

K 676

K 677

Z/3

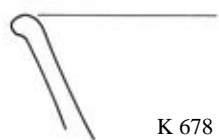

K 680

K 679

K 681

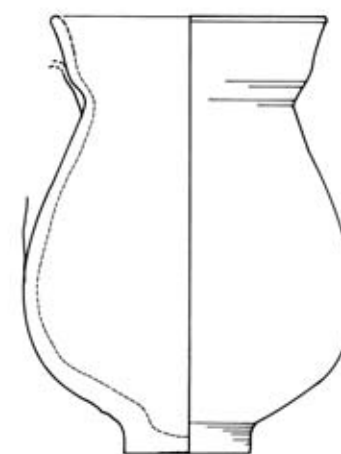
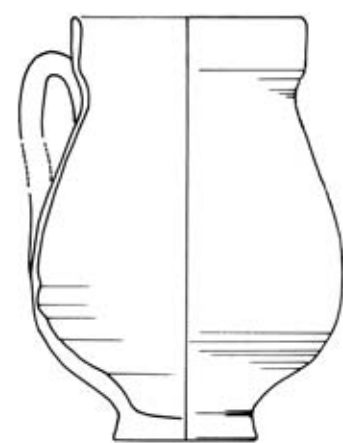
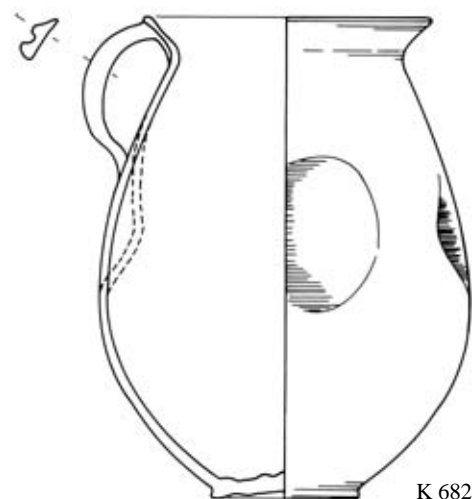

K 682

K 683

K 684

Z/4

0 10 cm

TAFEL 190

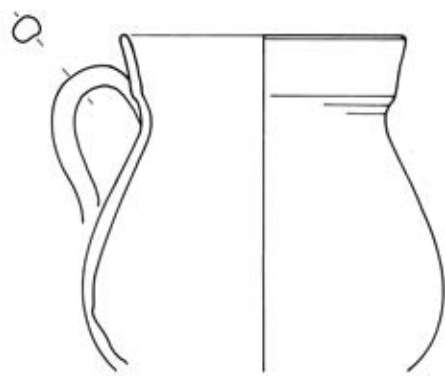

K 685

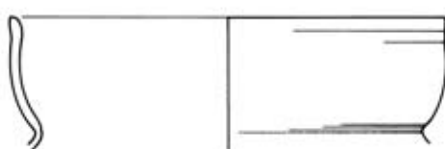

K 686

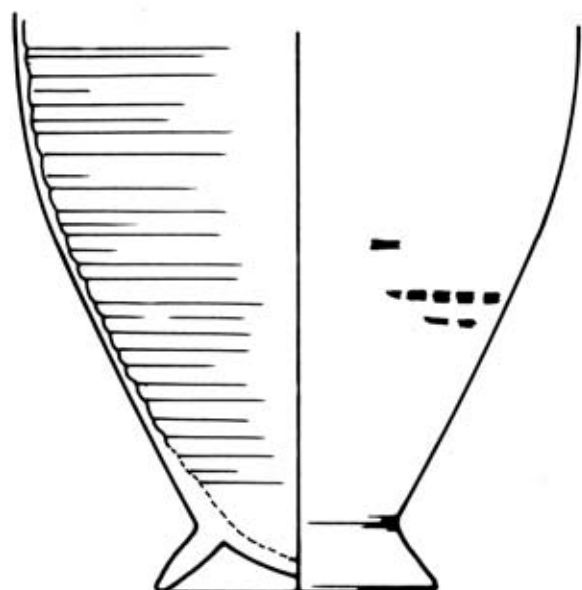

K 687

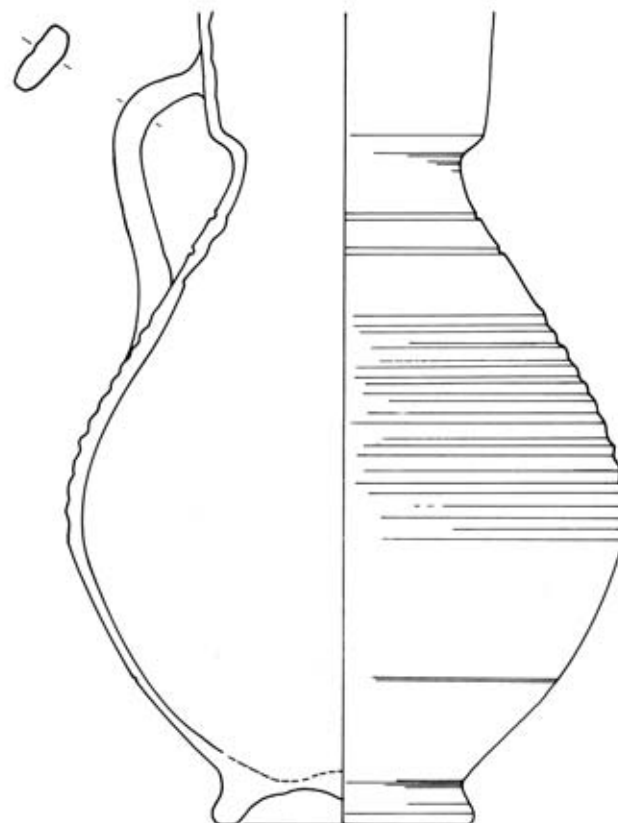

K 688

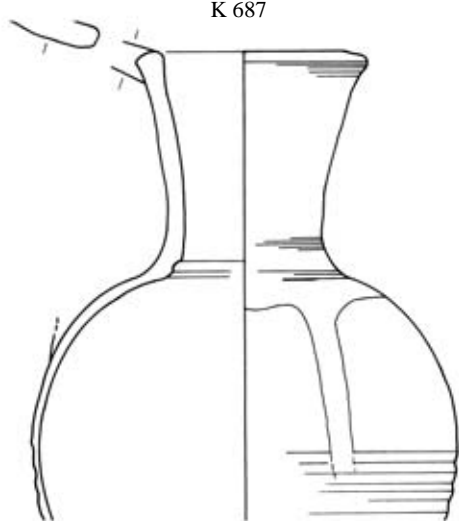

K 689

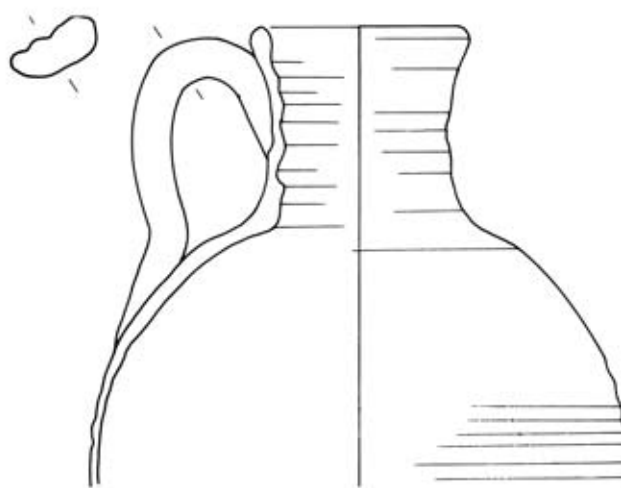

K 690

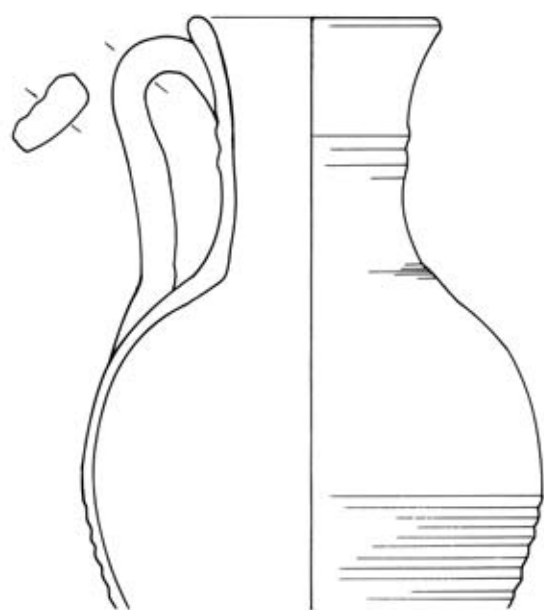

K 691

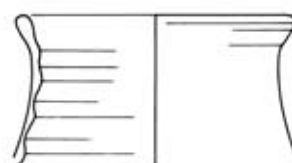

K 692

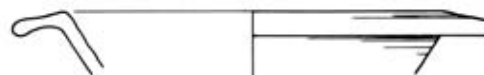

K 693



K 695



TAFEL 191

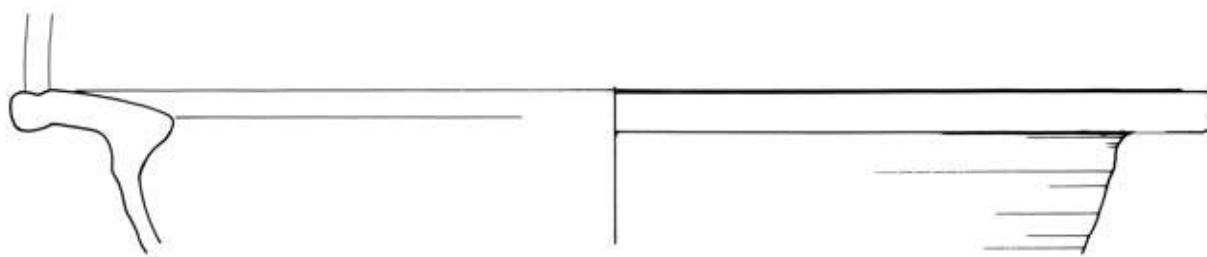

K 694



K 696

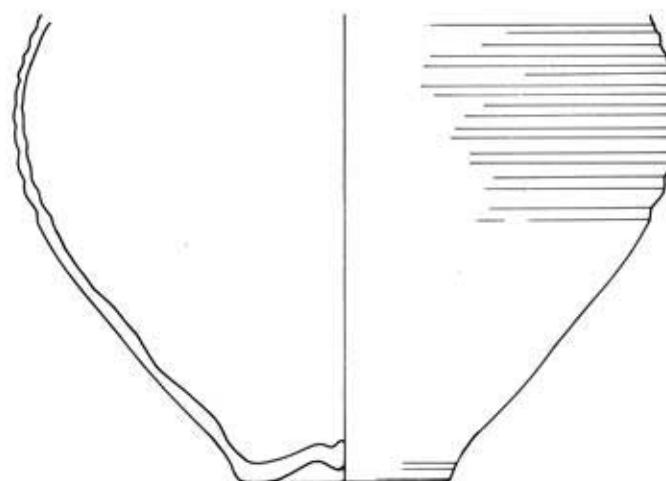

K 697

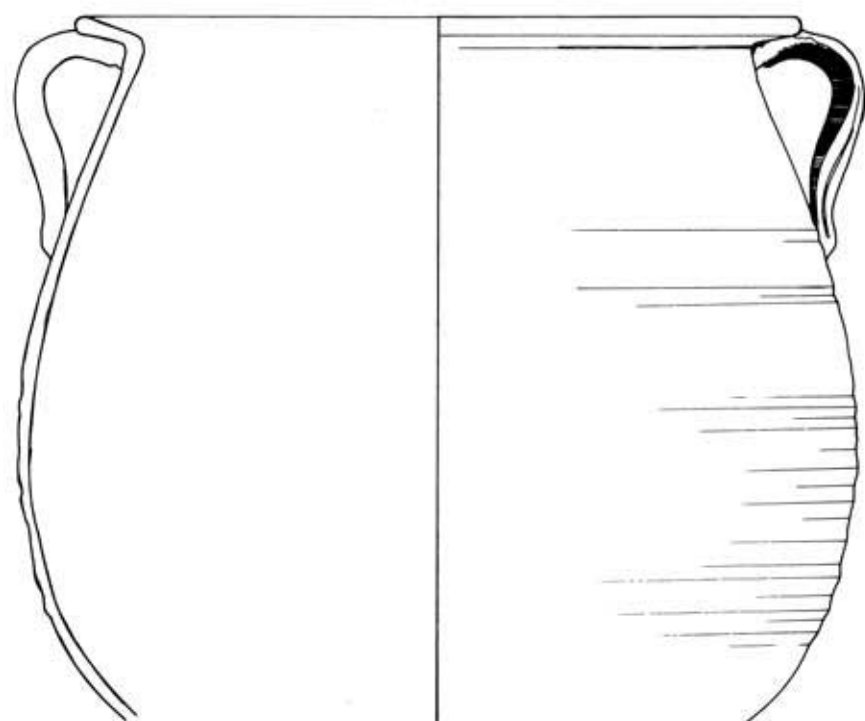

K 698

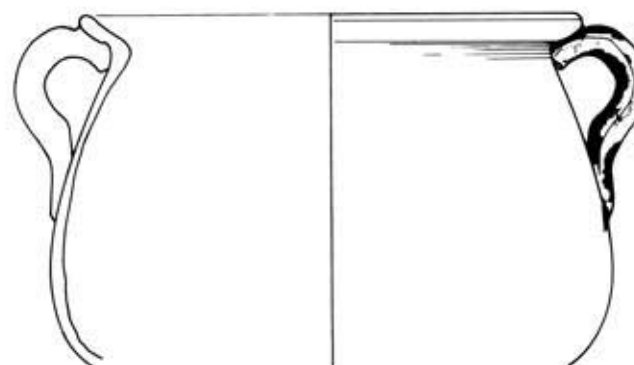

K 699

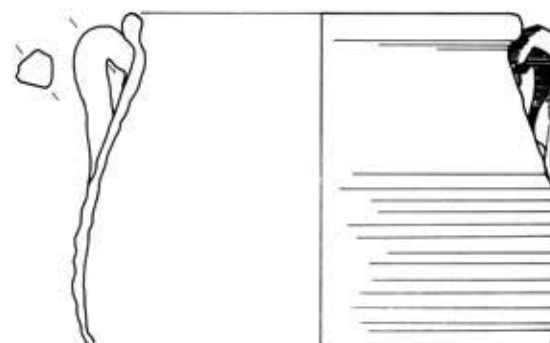

K 700

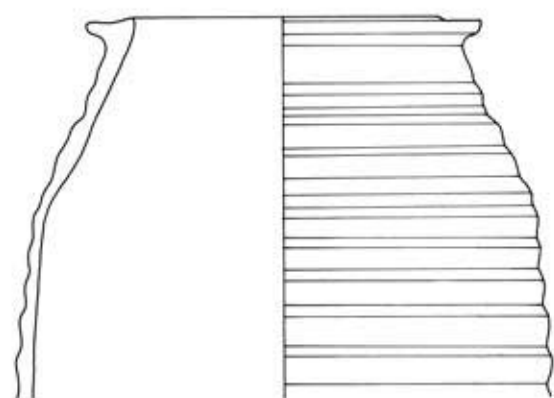

K 701

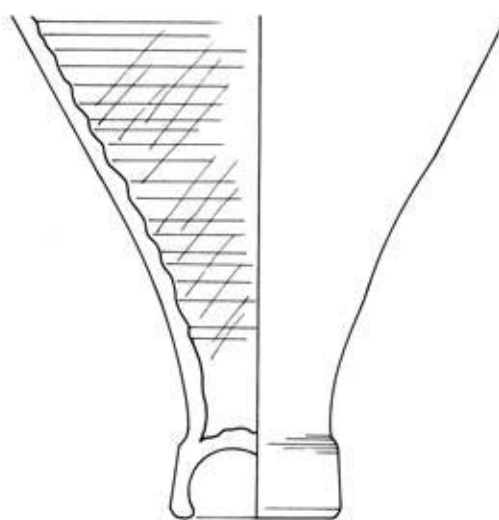

K 702

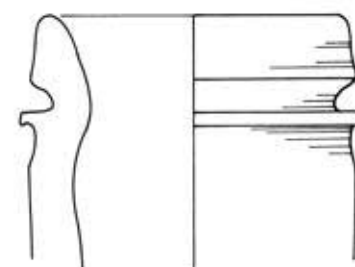

K 703

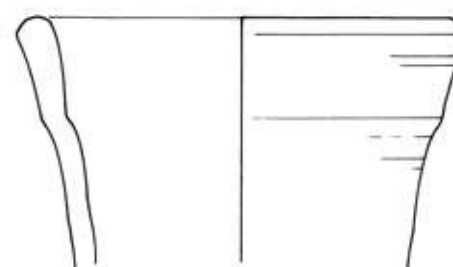

K 704

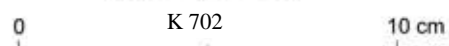

TAFEL 192

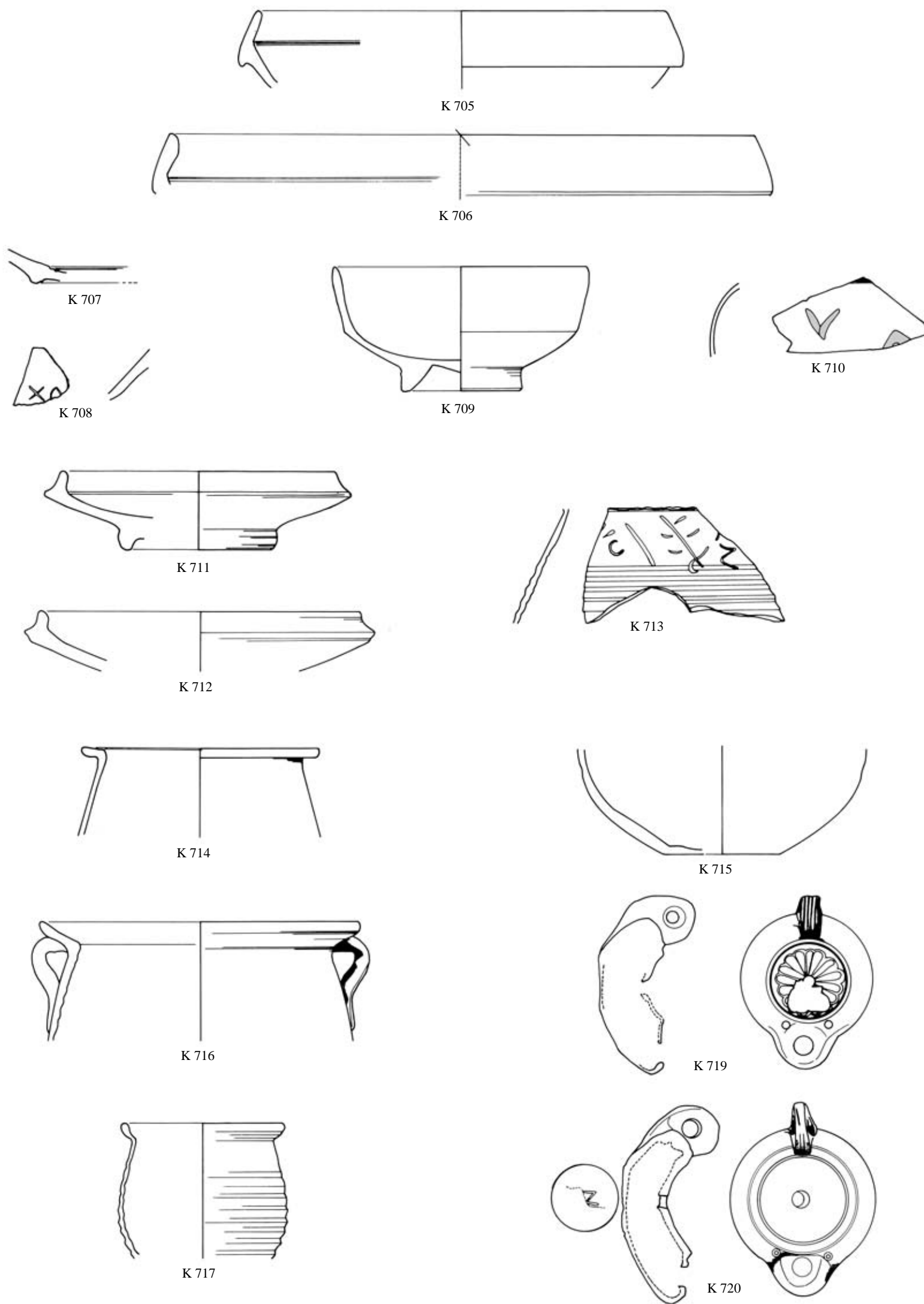

TAFEL 193

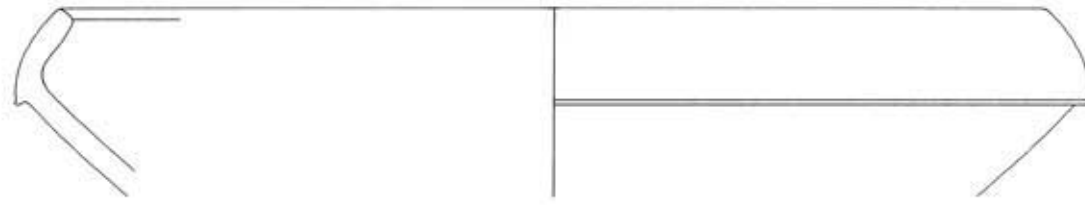

K 721

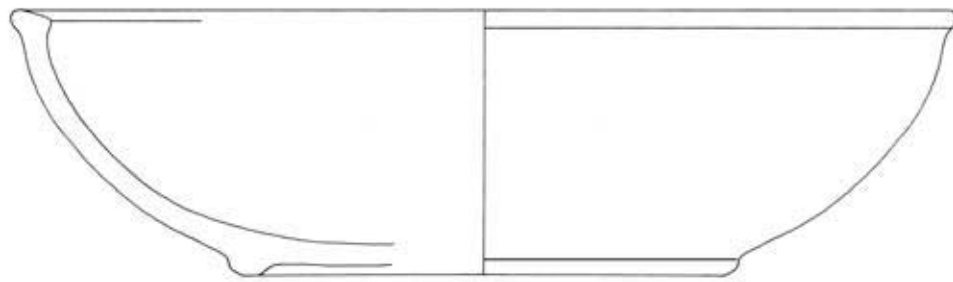

K 722

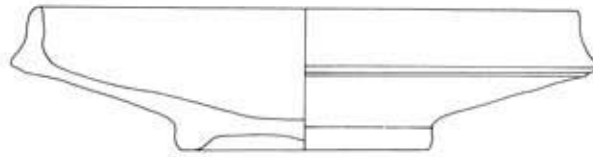

K 723



K 724

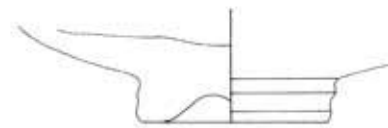

K 725



K 726

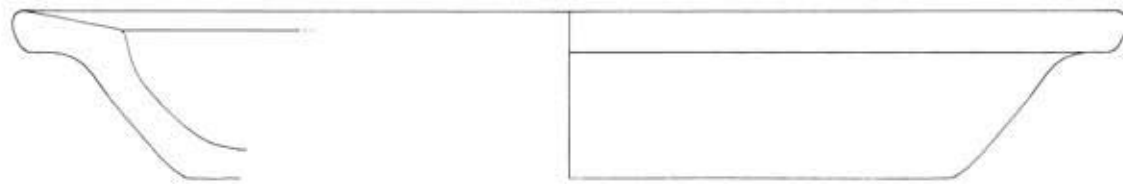

K 727

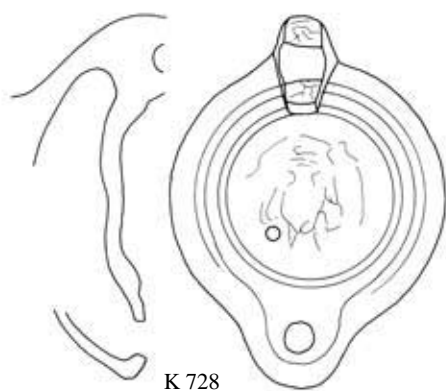

K 728

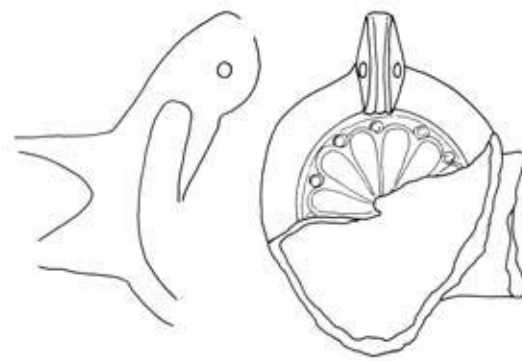

K 731



K 729

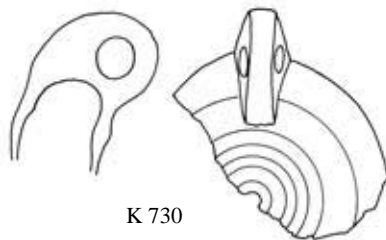

K 730



Z/6

TAFEL 194

