

Var.f Innen verdickter abgesetzter Mundsaum und Innenverzierung



Var.g Außen verdickter Mundsaum



Var.h Mit senkrecht stehendem Randlappen und Lochung

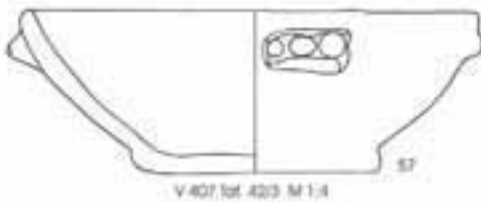

Var.i Grobe Form mit Griffrippen und waagrechter Fingerstichrauhung

Typ D Kalottenartige Form

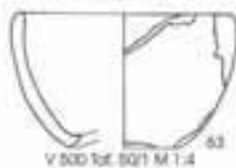

Var.a Rund oder spitz abgestrichener Mundsaum

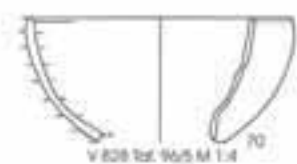

Var.b Schräg nach innen abgestrichener Mundsaum

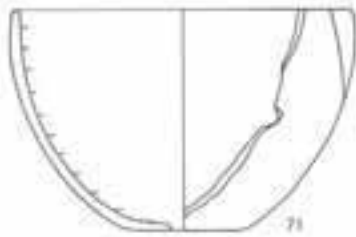

V 841 Tot. 105/3 M 1:4

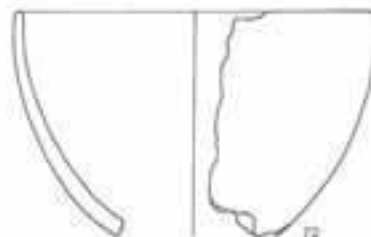

V 38 Tot. 11/6 M 1:4

Var.c Hohe Form, rund oder spitz abgestrichener Mundsaum



V 102 Tot. 16/12 M 1:4

Var.d Außen verdickter Mundsaum



V 841 Tot. 107/4 M 1:4

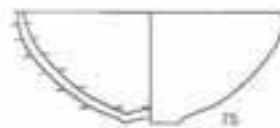

V 591 Tot. 82/13 M 1:4

Var.e Kleine abgesetzte innen gedellte Standfläche

Typ E Konisch bis steilkonische Form mit einziehendem Rand (Hohe Einzugsrandschale)



V 164 Tot. 33/2 M 1:4



V 573 Tot. 58/3 M 1:4



V 591 Tot. 64/7 M 1:4



V 831 Tot. 98/1 M 1:4



V 128 Tot. 25/9 M 1:4

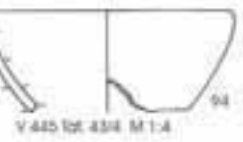
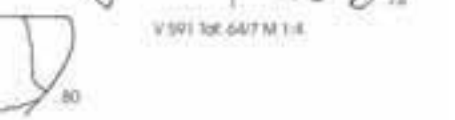

V 445 Tot. 43/4 M 1:4



V 729 Tot. 80/3 M 1:4



V 31 Tot. 9/9 M 1:4



V 164 Tot. 33/1 M 1:4



V 591 Tot. 64/9 M 1:4



V 803 Tot. 93/1 M 1:4



V 133 Tot. 30/6 M 1:4

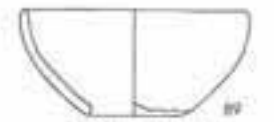

V 690 Tot. 74/3 M 1:4



V 106 Tot. 17/5 M 1:4



V 621 Tot. 68/5 M 1:4



V 183 Tot. 36/2 M 1:4



V 828 Tot. 96/8 M 1:4



V 841/1 Tot. 104/2 M 1:4



V 119 Tot. 13/9 M 1:4

Var.a Schwach einziehender Rand, mehr oder minder gewölbte Wandung

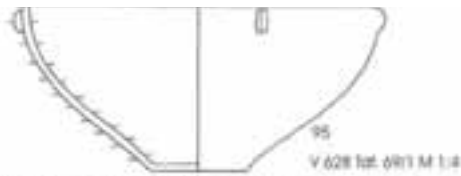

Var.b Schwach einziehender Rand, geschwungene Wandung und plastische Krübbe

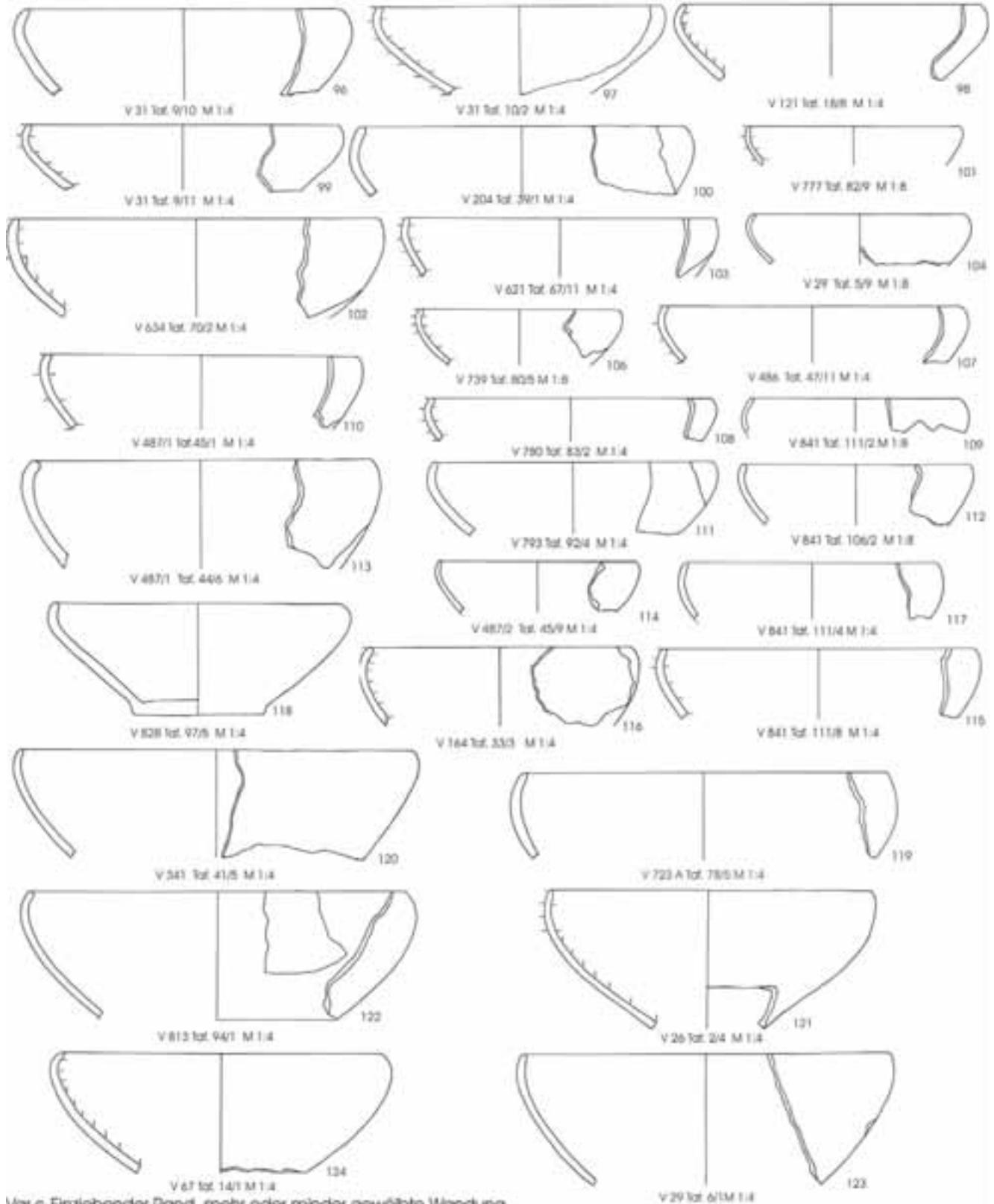

Var.c Einziehender Rand, mehr oder minder gewölbte Wandung



125
V 4872 lat. 45/2 M 1:4

Var.d Einziehender verzierter Rand, annähernd gerade Wandung



V 871 lat. 114/7 M 1:4



V 704 lat. 75/7 M 1:4



V 723 A lat. 77/7 M 1:4

126



V 67 lat. 15/2 M 1:4



V 690 lat. 74/5 M 1:4



V 801 lat. 66/4 M 1:4

131



V 29 lat. 5/12 M 1:4



V 767 lat. 90/5 M 1:4

133

Var.e Kurzer hakenförmig einziehender Rand, steilkonische annähernd gerade Wandung



V 500 lat. 50/2 M 1:4

135



V 723 A lat. 79/1 M 1:4

136

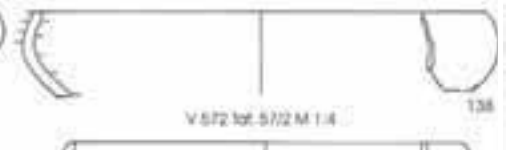

V 572 lat. 57/2 M 1:4

138



V 572 lat. 57/3 M 1:4

137



V 572 lat. 57/1M 1:4

139

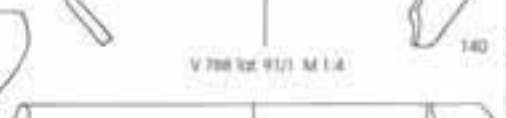

V 788 lat. 91/1 M 1:4

140



V 2-784 lat. 84/4 M 1:4

142



V 767 lat. 90/1M 1:4

143

V 591 lat. 55/1 M 1:4

141

V 500 lat. 50/5 M 1:4

134

Var.f Konisch einziehender Rand, konische annähernd gerade Wandung



V 2-784 lat. 84/2 M 1:4

145



V 36 lat. 11/7 M 1:4

149



V 715 lat. 77/2 M 1:4

146

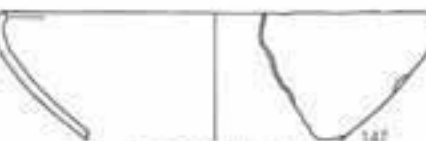

V 128 lat. 26/1 M 1:4

147



V 841 lat. 110/7 M 1:4

148



V 133 lat. 29/3 M 1:4

144



V 723 A lat. 75/5 M 1:4

150

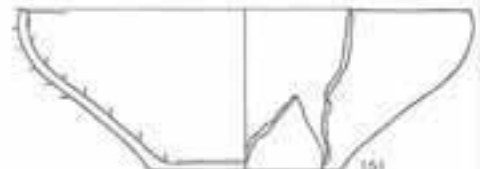

V 519 lat. 54/1 M 1:4

151

Var.g Formen mit nach innen schräg abgestrichenem Mundsaum

Typ F Form mit einziehendem Rand (Niedere Einzugsrandschale)

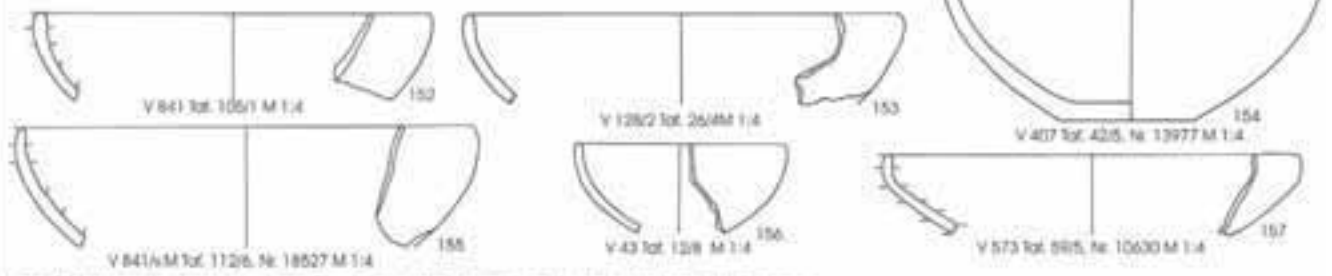

Var.a Schwach einziehender Rand; mehr oder weniger gewölbte Wandung

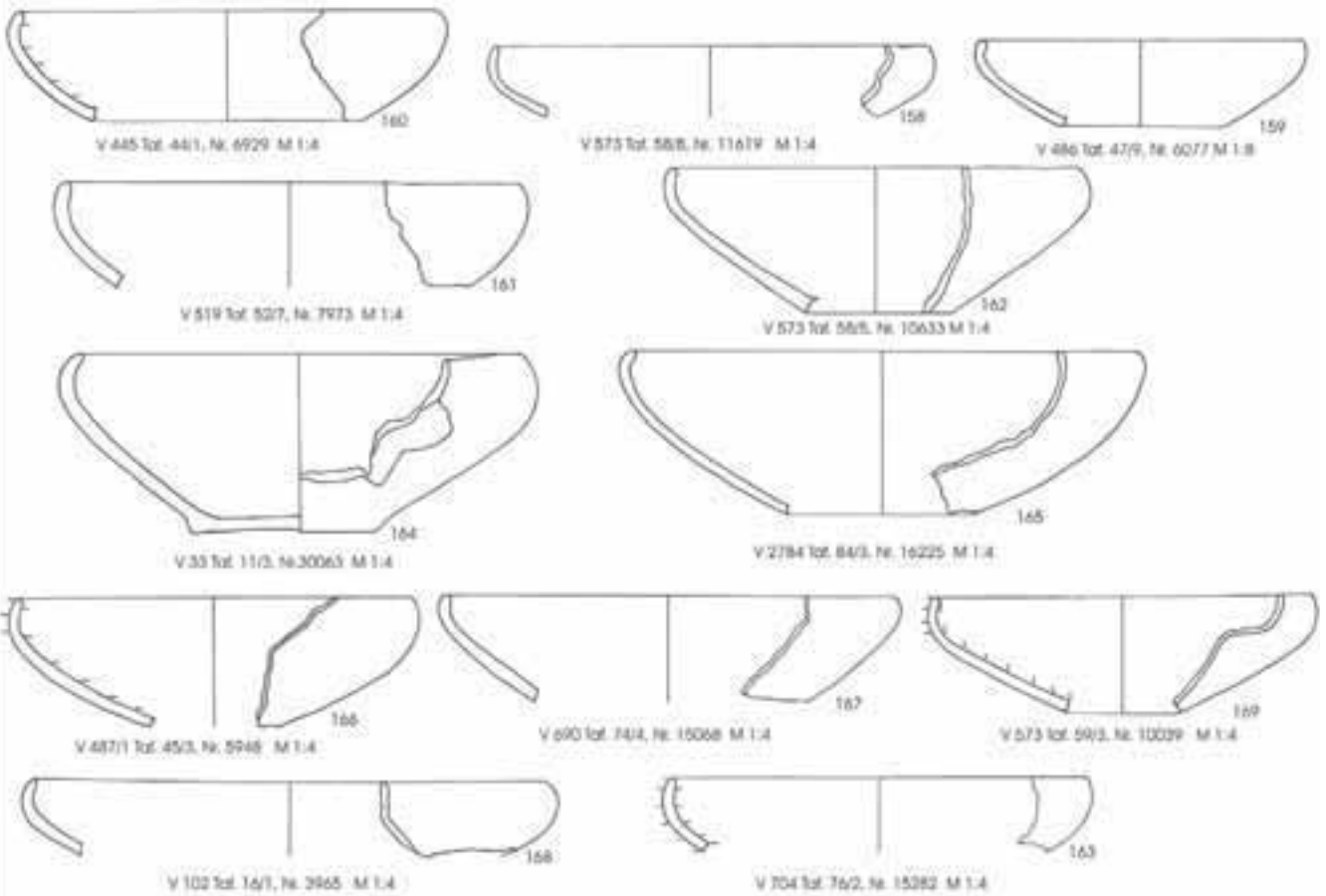

Var.b Einziehender Rand; mehr oder weniger gewölbte Wandung

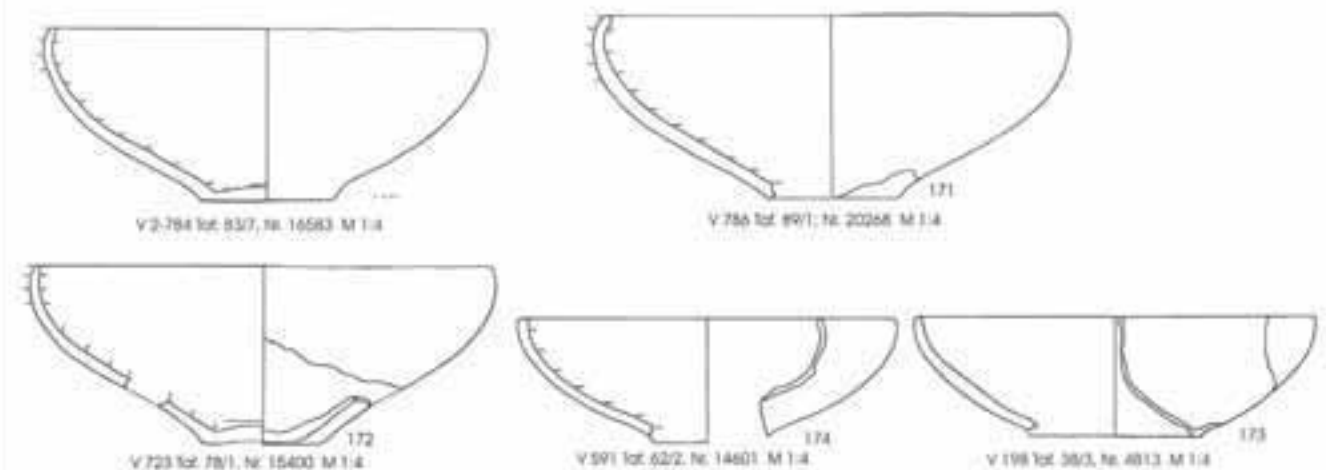



V 2-794 Tot. 83/5, Nr. 16222 M 1:4



V 2-794 Tot. 84/1, Nr. 16089 M 1:4



V 841/1 Tot. 109/5, Nr. 19630 M 1:4

Var.c Einziehender Rand; geschwungene Wandung



V 573 Tot. 59/7, Nr. 10870 M 1:4

Var.d Einziehender Rand; gedrückt geschwungene Wandung



V 486 Tot. 48/3, Nr. 30211 M 1:4

Var.e Einziehender verzierter Rand, annähernd gerade Wandung



V 121 Tot. 18/10, Nr. 868 M 1:4



V 102 Tot. 16/3, Nr. 3922 M 1:4



V 486 Tot. 48/1, Nr. 6021 M 1:4

Var.f Konisch einziehender Rand, annähernd gerade Wandung.



V 121 Tot. Tot. 24/2, Nr. 3402 M 1:4

Var.g Abgesetzt konisch einziehender Rand, annähernd gerade Wandung

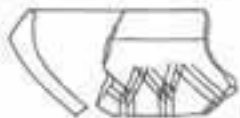

V 43 Tot. 12/7, Nr. 14848 M 1:4

Var.h Außen abgesetzt konisch einziehender Rand, gewölbte verzierte Wandung

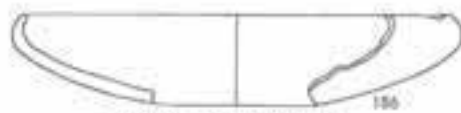

V 573 Tot. 58/9, Nr. 11627 M 1:4



V 487/2 Tot. 47/3, Nr. 6326 M 1:4

Var.i Tellerartige Form



V 813 Tot. 99/2, Nr. 20167 M 1:4

Var.j Schwach einziehender senkrechter Stellrand



V 869 Tot. 114/1, Nr. 21468 M 1:4



V 15 Tot. 1/5, Nr. 24405 M 1:4



V 898 Tot. 118/1, Nr. 22830 M 1:4

Var.k Einziehender Rand; kalottenartig gewölbte Wandung

Typ G Form mit facettiertem einziehendem Rand



192
V 106 Taf. 17/4, Nr. 3862 M 1:4

Var.a Zweifach umlaufend facettiert

Typ H Form mit schräg kannelliertem Rand und welliger Mundsaumgestaltung
(Echter Turbanrand)

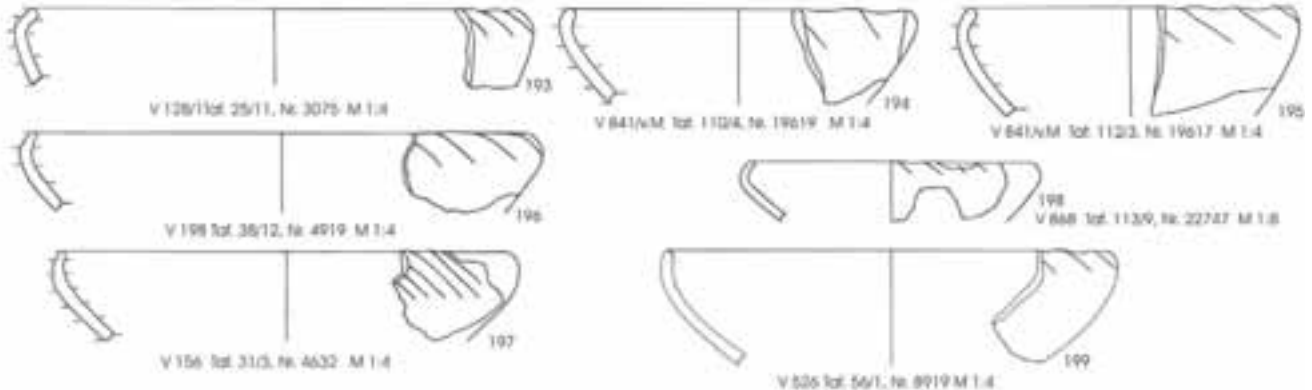

V 128/1 Taf. 25/11, Nr. 3075 M 1:4

V 641/vM Taf. 112/6, Nr. 19619 M 1:4

V 641/vM Taf. 112/3, Nr. 19617 M 1:4

V 198 Taf. 35/12, Nr. 4919 M 1:4

V 668 Taf. 113/9, Nr. 22747 M 1:8

V 156 Taf. 31/3, Nr. 4632 M 1:4

V 535 Taf. 56/1, Nr. 8919 M 1:4

Var.a Hohe Form, mehr oder minder gewölbte Wandung



V 198 Taf. 36/6, Nr. 4811 M 1:8

201
V 526 Taf. 56/2, Nr. 8920 M 1:4

Var.b Hohe Form, kurzer Turbanrand



V 156 Taf. 31/1, Nr. 4545 M 1:4

V 171 Taf. 33/6, Nr. 4765 M 1:4

Var.c Hohe Form, kalottenartig gewölbte Wandung



204
V 834 Taf. 99/7, Nr. 21021 M 1:4

Var.d Hohe Form mit gegenständigem Ösenhenkel (Hängegefäß)



205
V 610 Taf. 50/5, Nr. 7498 M 1:4

Var.e Niedere Form, kragenartiger Stellrand



206
V 628 Taf. 69/5, Nr. 12008 M 1:4

Var.f Niedere Form, dickwandig mit Warzenzier



207
V 503 Taf. 52/7, Nr. 13947 M 1:4

Var.g Niedere Form, dickwandig mit Handhaben



208
V 121/2 Taf. 24/1, Nr. 3434 M 1:4



209
V 704 Taf. 76/9, Nr. 15198 M 1:8



210
V 121 Taf. 21/1, Nr. 4158 M 1:8

Var.h Tellerartige Form

Typ I Form mit schräg kanneliertem Rand und gerader Mundsaumgestaltung (Falscher Turbanrand)

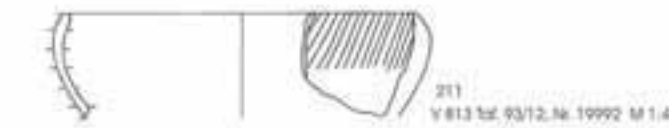

211
V 813 Taf. 93/12, Nr. 19992 M 1:4



212
V 31 Taf. 10/1, Nr. 24409 M 1:4



213
V 38 + V 33 Taf. 12/4, Nr. 30068 M 1:4

Var.a Hohe Form, mehr oder minder gewölbte Wandung



214
V 128/2 Taf. 28/7, Nr. 2091 M 1:4

Var.b Niedere Form, annähernd gerade Wandung



215
V 121 Taf. 22/5, Nr. 3688 M 1:4

Var.c Niedere Form, schräg nach innen abgestrichener Mundsaum

Typ J Schalen mit Graphit(mal)muster

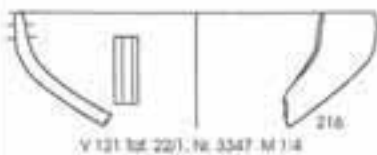

216
V 121 Taf. 22/1, Nr. 3547 M 1:4



217
V 121 Taf. 21/2, Nr. 3571 M 1:4



218
V 841/1 Taf. 104/3, Nr. 18154 M 1:4



219
V 487/2 Taf. 47/1, Nr. 6313 M 1:4



220
V 487/2 Taf. 46/6, Nr. 6320 M 1:4

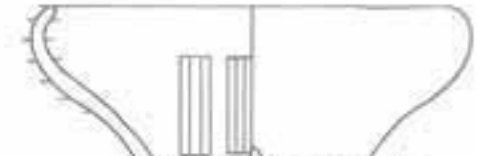

221
V 487/1 Taf. 44/4, Nr. 13945 M 1:4



222
V 573 Taf. 56/6, Nr. 11487 M 1:8



223
V 573 Taf. 59/1, Nr. 11409 M 1:8

Var.a Senkrechte Anordnung



224
V 121 Taf. 24/3, Nr. 3424 M 1:4



225
V 486 Taf. 48/2, Nr. 8000 M 1:4

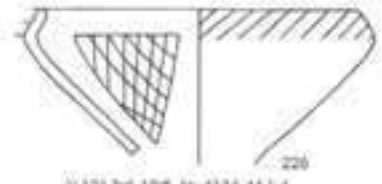

226
V 121 Taf. 19/5, Nr. 4134 M 1:4

Var.b Dreieckige Anordnung

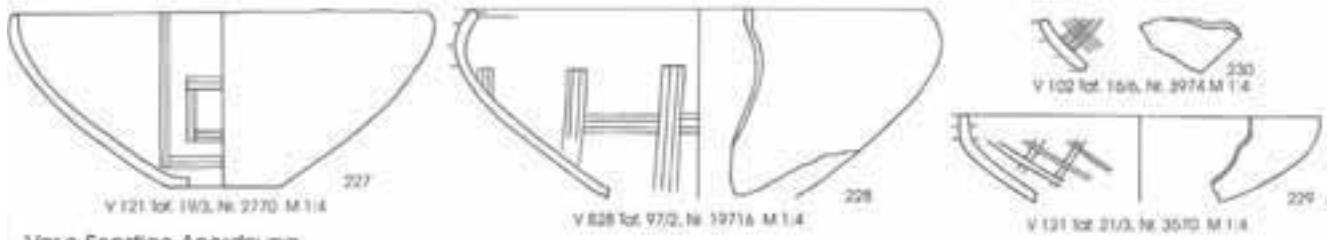

Var.c Sonstige Anordnung

HENKELSCHALEN

Typ A Steilkonische Form

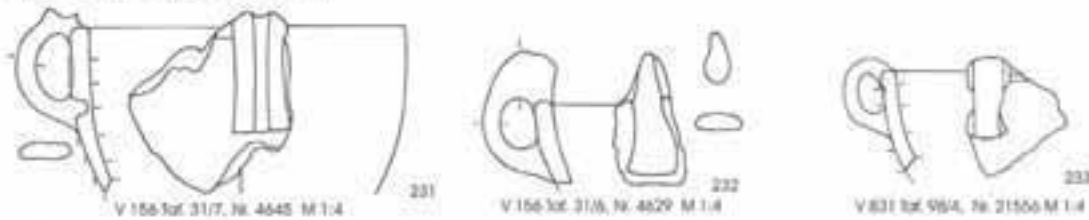

Var.a Überrandständiger Henkel



Var.b Unterrandständiger Henkel

Typ B Konische Form



Var.a Überrandständiger Henkel, Rand schwach einziehend

Typ C Flachkonische Form

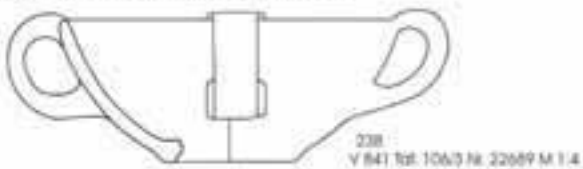

Var.a Gegenständlicher Überrandständiger Henkel

Typ D Form mit zum Rand hin gewölbt einziehender Wandung

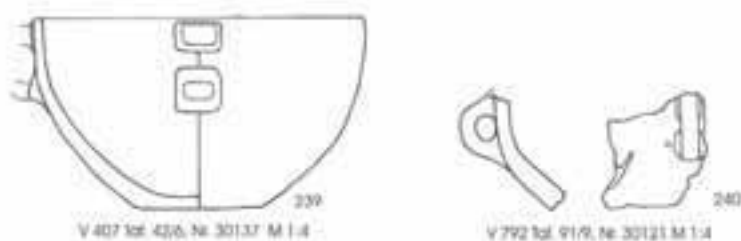

Var.a Weitmündige Form, unterrändständiger Henkel

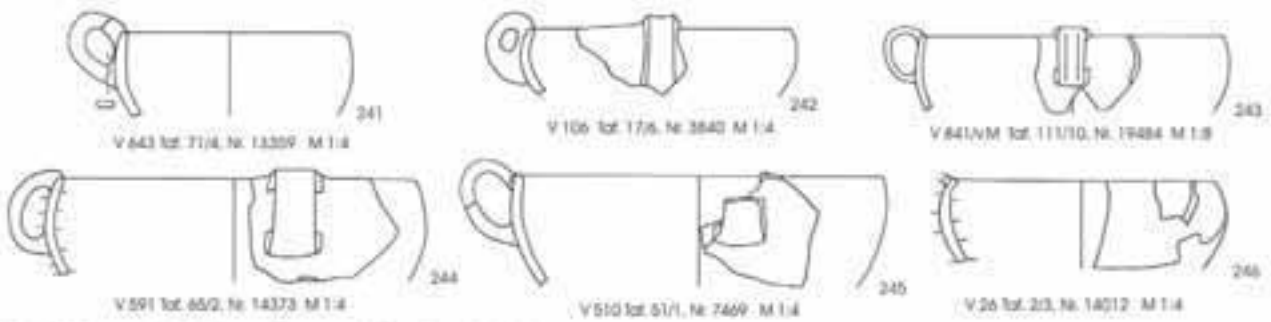

Var. b Weitmundige Form, überrandständiger Henkel

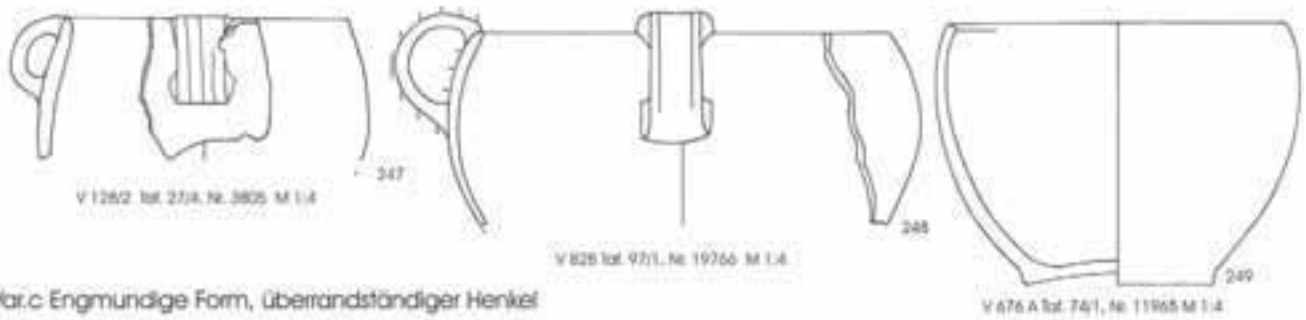

Var. c Engmundige Form, überrandständiger Henkel

Typ E Form mit zum Rand hin konisch einziehender Wandung



Var. a überrandständiger Henkel

SCHÜSSEL

Typ A Form mit innen abgesetzter trichterförmig ausladender Randbildung



Var. a Innen verdickt



Var. b Polychrome Innenverzierung

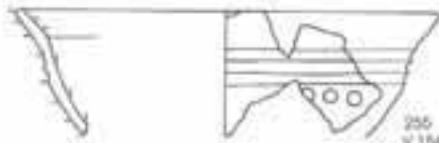

255
V 156 lat. 31/5, Nr. 462B M 1:4

Var.c Hohe Form



256
V 841/vM lat. 1127, Nr. 1962B M 1:4

Var.d Verzierter Rand

Typ B Form mit Rand- und Schulterbildung

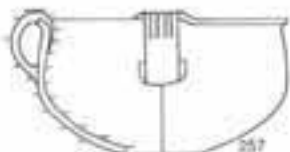

257
V 648 lat. 72/2, Nr. 13760 M 1:4



258
V 341 lat. 41/6 Nr. 13941 M 1:4

Var.a Gerundet ausladender Rand



259
V 841/1 lat. 1092, Nr. 1964F M 1:4



V 841/a M lat. 111/3, Nr. 1965b M 1:4



V 750 lat. 81/4, Nr. 15660 M 1:4

Var.b Innen abgesetzter trichterförmig ausladender Rand



262
V 27 lat. 6/2, Nr. 14020 M 1:4

Var.c Innen abgesetzter kurz ausbiegender Rand, geschwungenes Unterteil



V 102 lat. 16/5, Nr. 3990 M 1:4

Var.d Innen abgesetzter kurz ausbiegender Rand und Verzierung



V 121 lat. 19/1, Nr. 34353 M 1:4



V 573 lat. 5W9, Nr. 11568 M 1:8

Var.e Innen abgesetzter kurz ausbiegender Rand, gedrückte Form

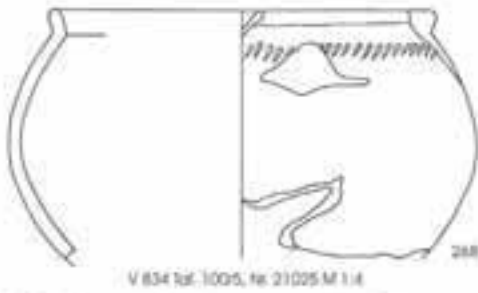

V 834 Taf. 1005, Nr. 21025 M 1:4

Var.f Trichterrand, hohe engmundige Form



V 841/M Taf. 1111/1, Nr. 19480 M 1:4

V 891 Taf. 63/1, Nr. 14512 M 1:4



V 29 Taf. 85, Nr. 30041 M 1:4

Var.g Trichterrand, niedere weitmündige Form

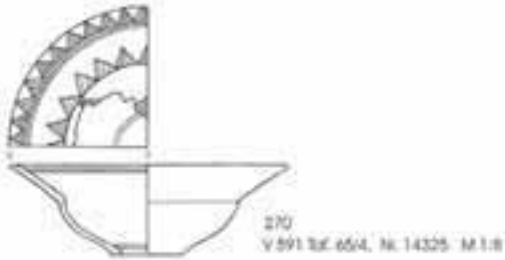

V 891 Taf. 65/4, Nr. 14325 M 1:8

Var.h Weit ausladender Trichterrand und Innerverzierung



V 573 Taf. 96/11, Nr. 10038 M 1:4



V 573 Taf. 62/1, Nr. 11542 M 1:4



V 573 Taf. 96/12, Nr. 10284 M 1:4

Var.i Hoher Trichterrand, gedrückte Form



V 891 Taf. 63/3, Nr. 14523 M 1:4



V 31 Taf. 108, Nr. 24418 M 1:4



V 186 Taf. 32/2, Nr. 4025 M 1:4

Var.j Krugenartiger Stellrand, flachbauchige engmundige Form

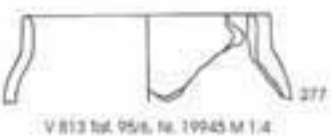

V 813 Taf. 95/6, Nr. 19945 M 1:4



V 777 Taf. 82/5, Nr. 16460 M 1:4



V 777 Taf. 82/5, Nr. 16497 M 1:4



V 788 A Taf. 91/4, Nr. 20920 M 1:4

Var.k Krugenartiger Stellrand, bauchige engmundige Form



V 841/M Taf. 111/7, Nr. 19819 M 1:4

Var.l Krugenartiger Stellrand, weitmündige Form

Typ C Form mit abgesetzter gekehlter Schulter und trichterförmiger Randbildung

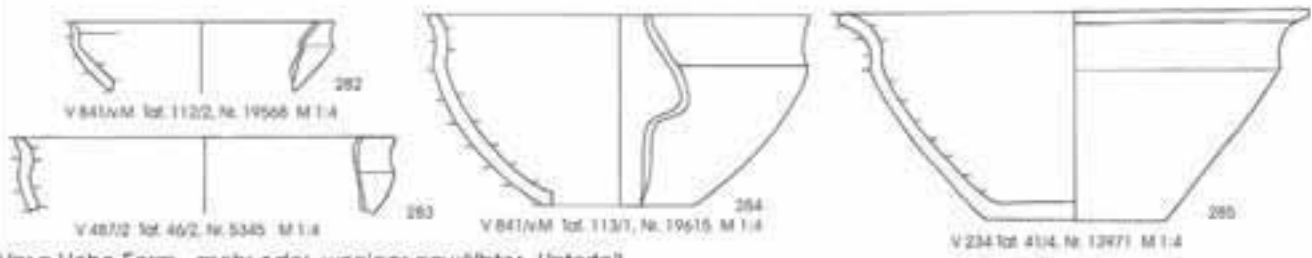

Var.a Hohe Form, mehr oder weniger gewölbtes Unterteil



Var.b Form mit Lappenbildung



Var.c Niedere verzierte Form, gewölbtes Unterteil



Var.d Niedere Form, annähernd gerades Unterteil und Henkelbildung



Var.e Tassenartige Form

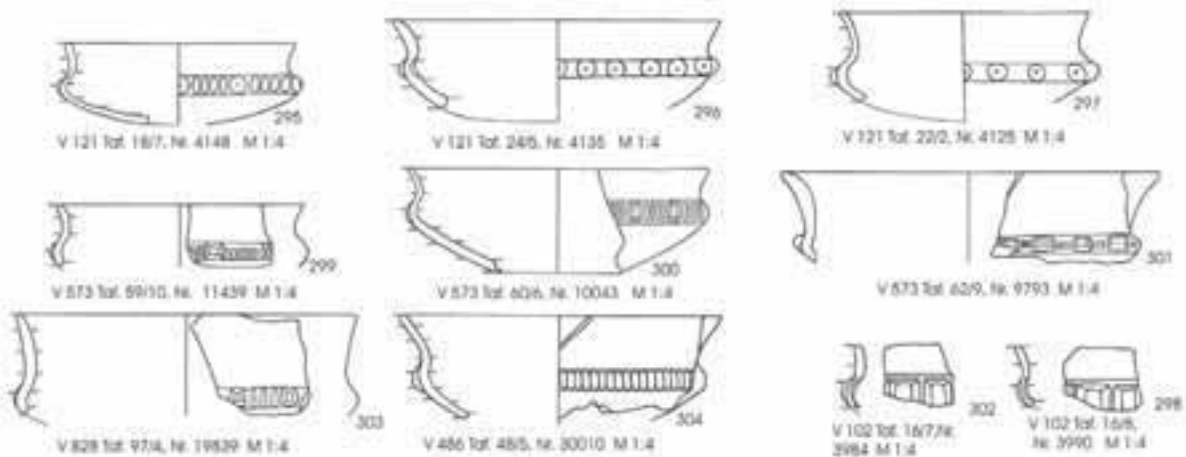

Var.f Niedere Form, betonter verzierter Bauchbereich



Var.g Niedere Form, betontes verziertes Unterteil

Typ D Form mit durchschwingender Halsbildung (s-förmige Profilierung)



V 126/1 Taf. 25/1, Nr. 3090 M 1:4 V 128/1 Taf. 25/3, Nr. 1711 M 1:4 V 787 Taf. 89/5, Nr. 20566 M 1:4 V 787 Taf. 89/7, Nr. 20569 M 1:4

Var.a Weitmundige flachbauchige kleine Form



V 787 Taf. 90/15, Nr. 20543 M 1:8

Var.b Weitmundige flachbauchige große Form, gegenständige Henkel

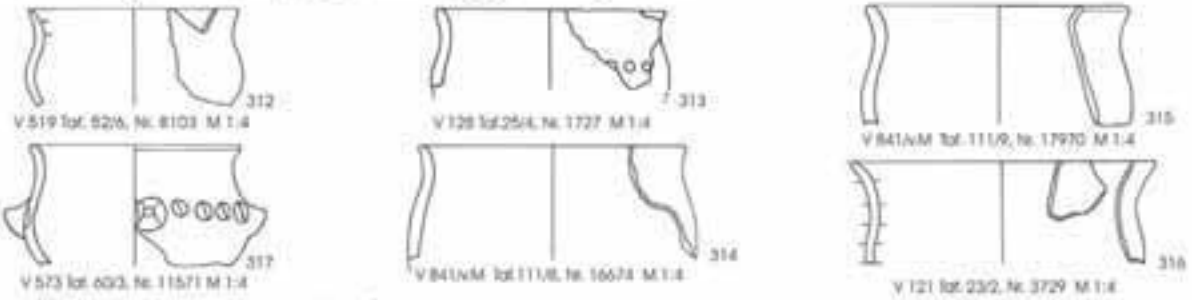

V 519 Taf. 62/6, Nr. 8103 M 1:4 V 128 Taf. 25/4, Nr. 1727 M 1:4 V 841/M Taf. 111/9, Nr. 17970 M 1:4 V 573 Taf. 60/3, Nr. 11571 M 1:4 V 841/M Taf. 111/8, Nr. 16674 M 1:4 V 121 Taf. 23/2, Nr. 3729 M 1:4

Var.c Hohe engmundige (tassenartige) Form



V 29 Taf. 6/10, Nr. 306 M 1:4 V 573 Taf. 60/71, Nr. 11441 M 1:4

Var.d Niedere bauchige Form

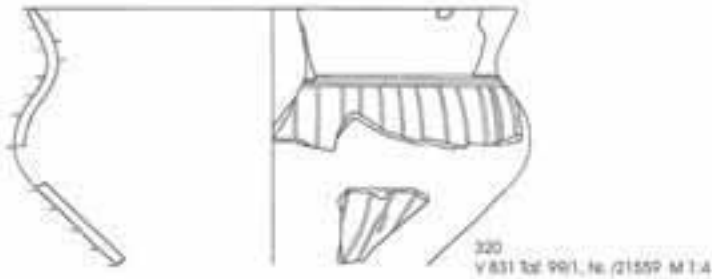

V 831 Taf. 99/1, Nr. 21559 M 1:4

Var.e Bauchige Form, weit ausladende trichterförmige Randbildung

Typ E Form mit geschwungen einziehender Halsbildung

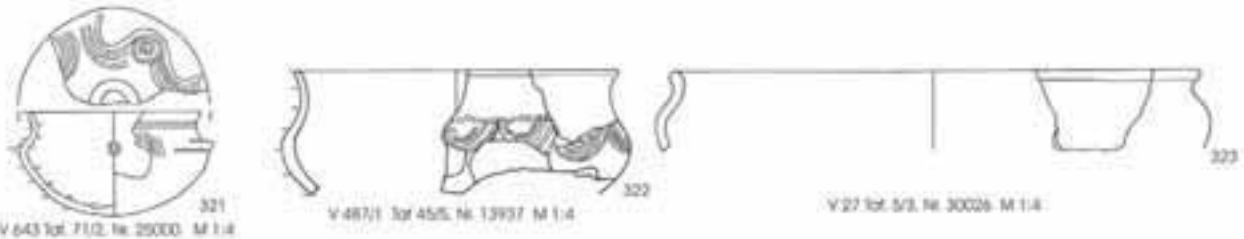

V 643 Taf. 71/2, Nr. 20000 M 1:4



V 487/1 Taf. 45/5, Nr. 13937 M 1:4

V 27 Taf. 5/3, Nr. 30026 M 1:4

Var.a Steil gerundete Schulter ohne Bauchknick



V 841/M Taf. 111/5, Nr. 19636 M 1:4 V 121 Taf. 24/4, Nr. 3415 M 1:4 V 885 Taf. 116/5, Nr. 22332 M 1:4 V 128 Taf. 24/2, Nr. 3085 M 1:4 V 133 Taf. 29/4, Nr. 2270 M 1:4

Var.b Gekehlte Schulter und Bauchknick

Typ F Form mit Kegelhals



Var.a Konisches Unterteil, abgesetzter Kegelhals ohne Randgestaltung

Typ G Form mit Zylinderhals



Var.a Rundbauchige Form ohne Randgestaltung

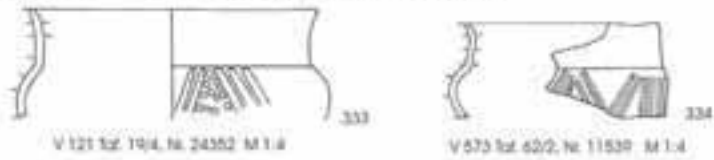

Var.b Rundbauchige Form mit Randgestaltung



Var.c Spitzbauchige Form mit Randgestaltung

TASSEN

Typ A Form mit Kegel- oder Zylinderhals

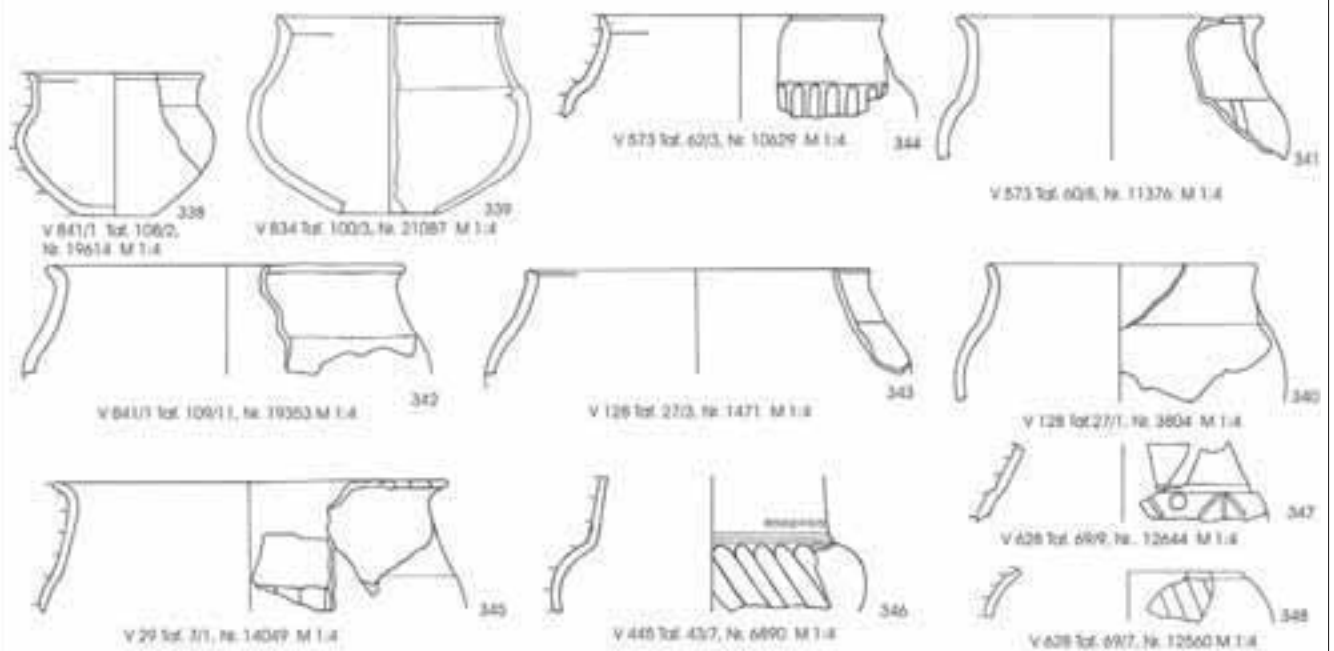

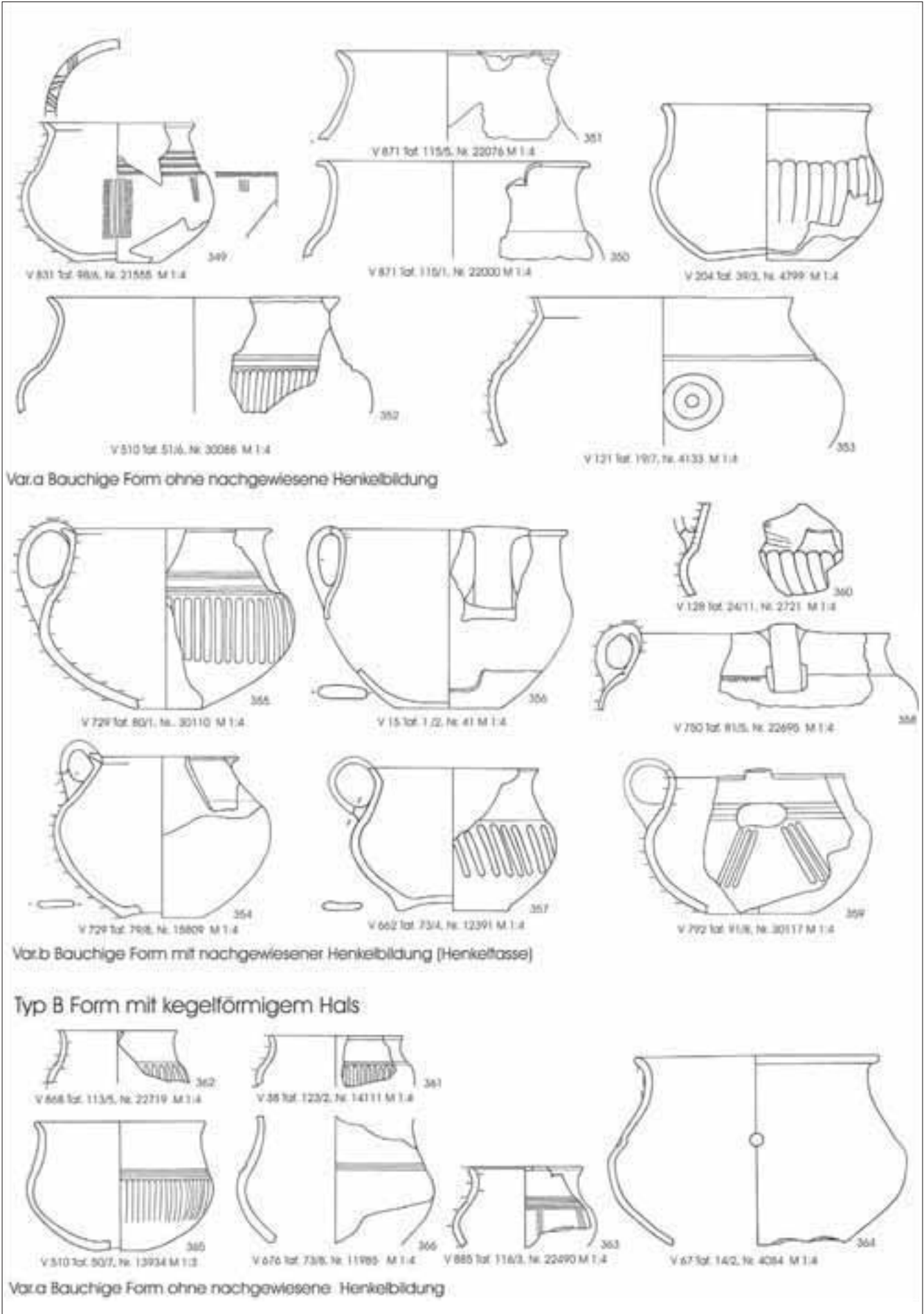

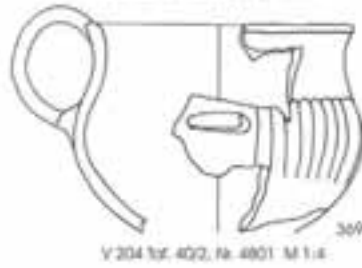

Var.b Bauchige Form mit nachgewiesener Henkelbildung (Henkelfasse)

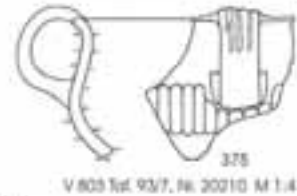
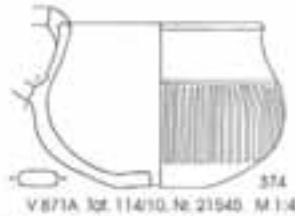
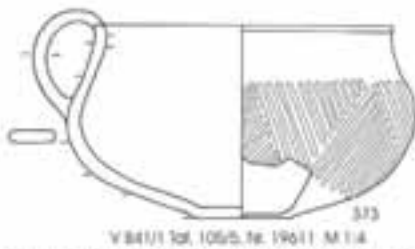

Var.c Gedrückte bauchige Form mit nachgewiesener Henkelbildung (Henkelfasse)

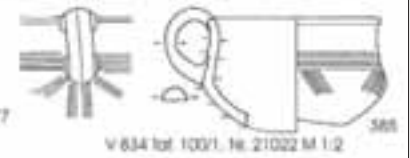
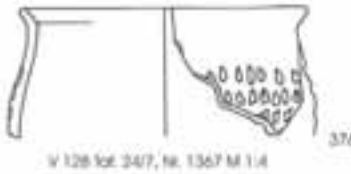

Var.d Kleine Form ohne ausgeprägte Schulterbildung



Var.e Große Form ohne ausgeprägte Schulterbildung und Henkel



Var.f Gekehlte Schulter und Bauchknick

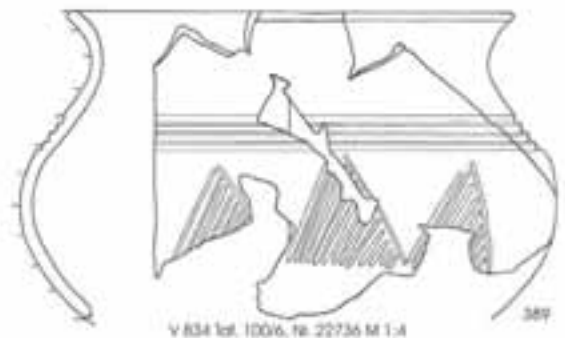
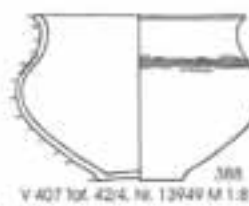

Var.g Große schüsselartige bauchige Form

Typ C Form mit kurzer durchschwingener Halsbildung (s-förmige Profilierung)

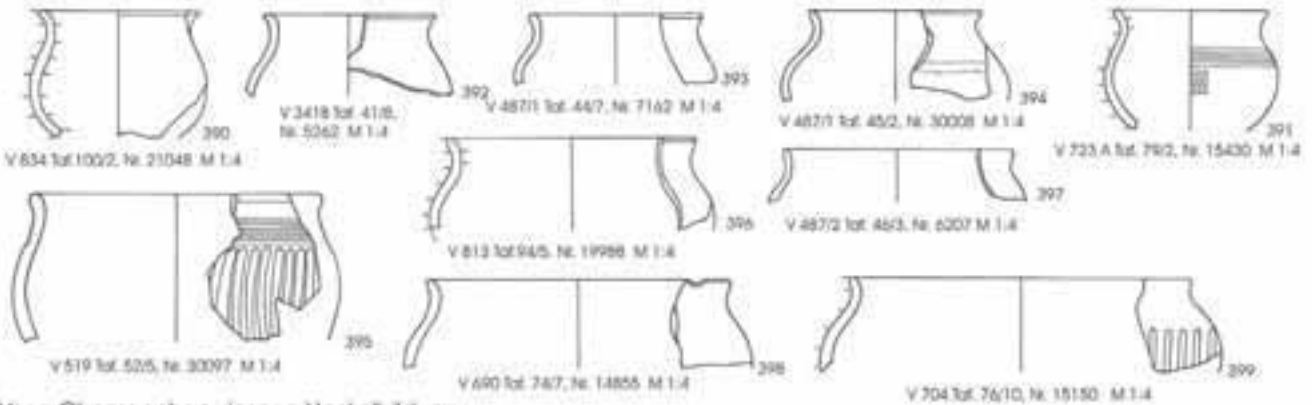

Var.a Ohne nachgewiesene Henkelbildung

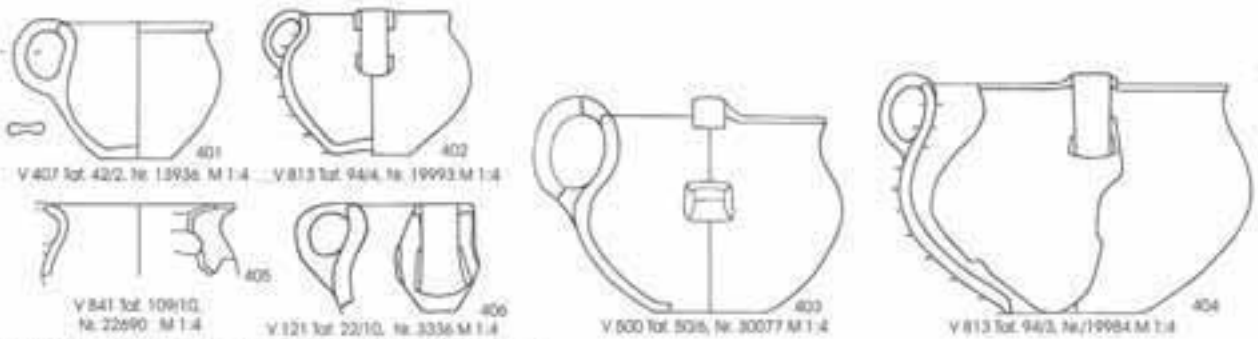

Var.b Mit nachgewiesener Henkelbildung (Henkeltasse)

Typ D Rand- und Halsstücke von feinen Hochformen

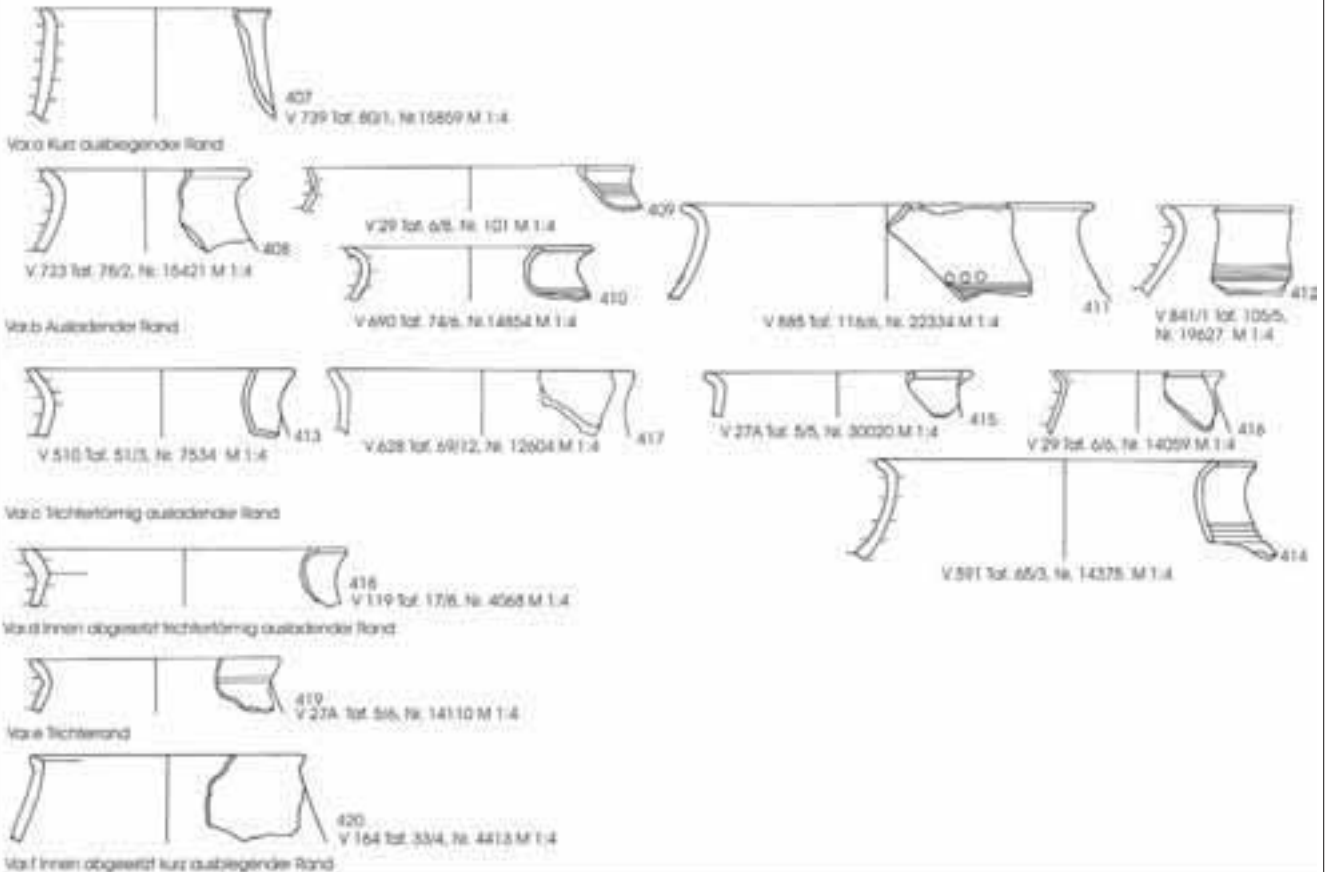

TOPF 1

Typ A Form mit kegelförmigem Hals

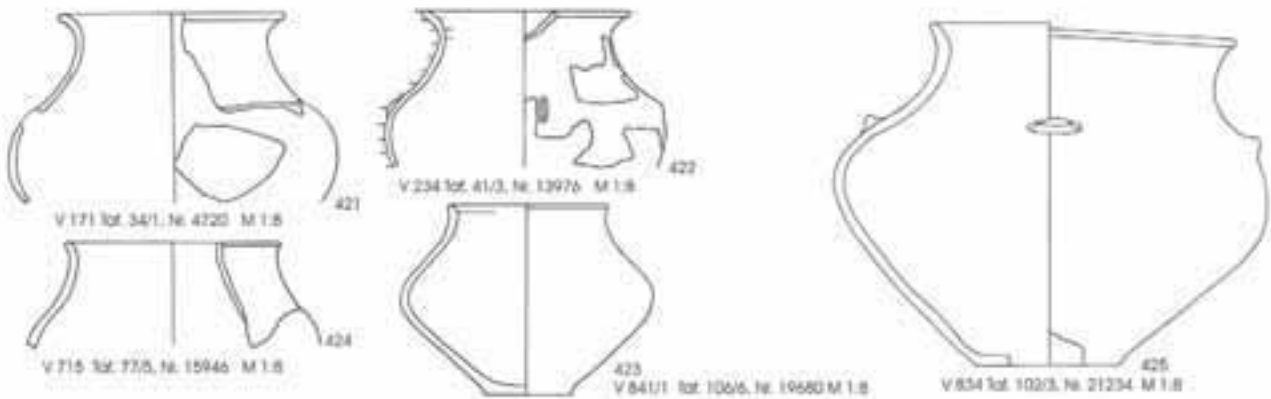

Var.a Relativ niedere, optisch breite Halsgestaltung

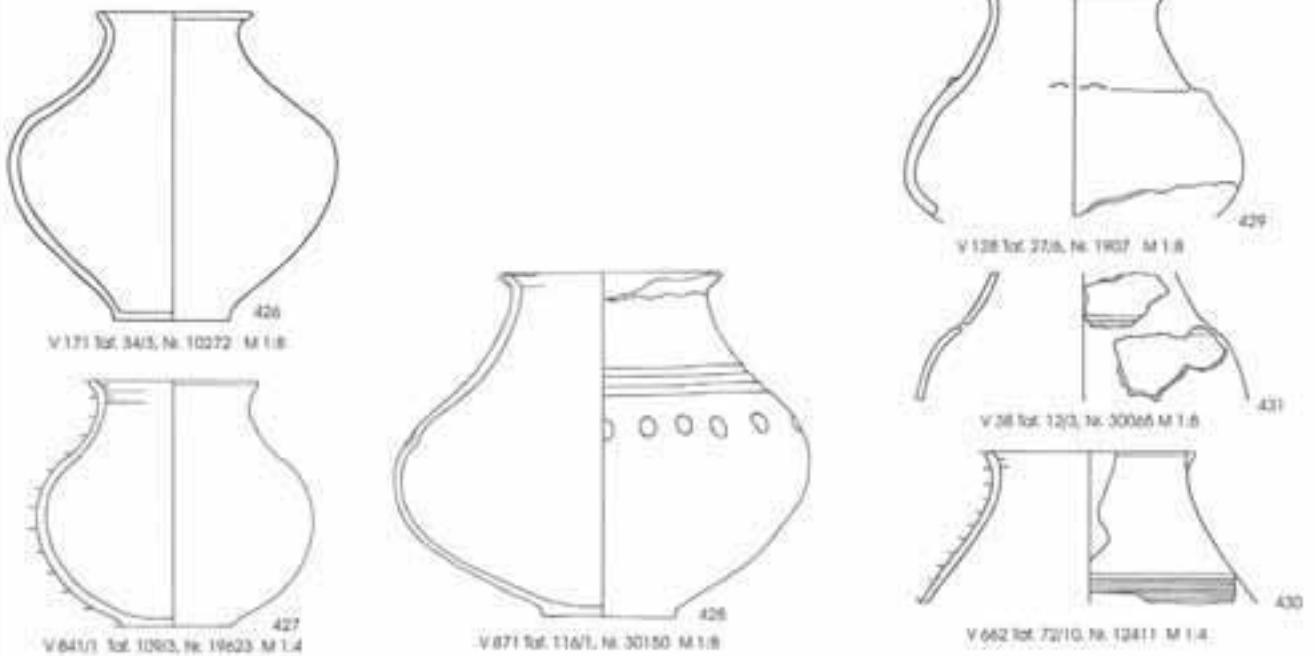

Var.b Relativ höhere, optisch enge Halsgestaltung



Var.c Vom Hals abgesetzter gekerbt trichterförmig ausladender Rand



Var.d Schwach gewölbter kegelförmiger Halsteil

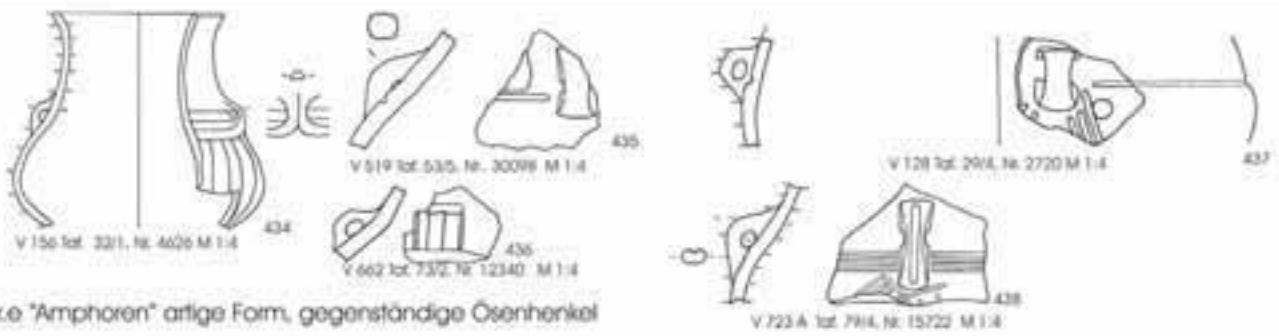

Var.e "Amphoren"-artige Form, gegenständige Ösenhenkel

Typ B Bauchige Form mit kurzer durchschwingender Halsbildung (s-förmige Profilierung)

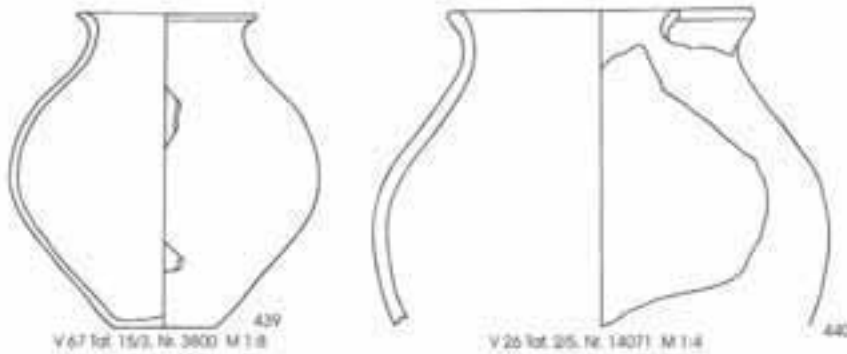

Var.a Ausladender Rand

Typ C Form mit Kegelhals

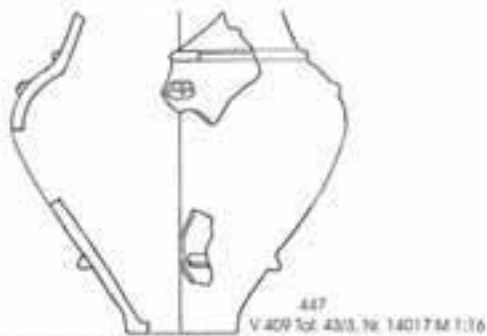
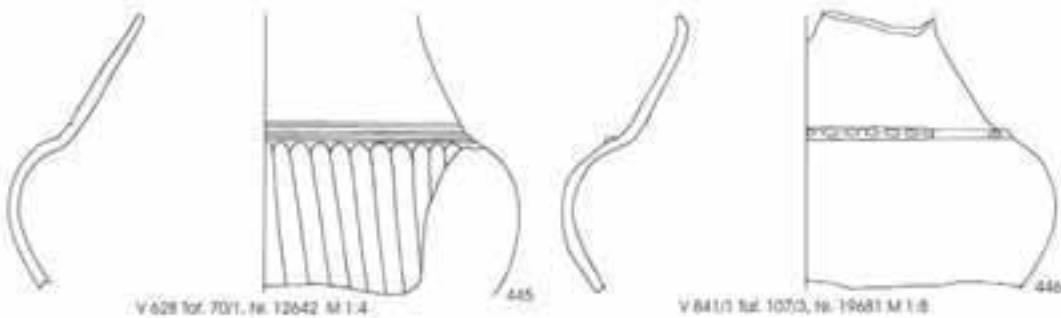
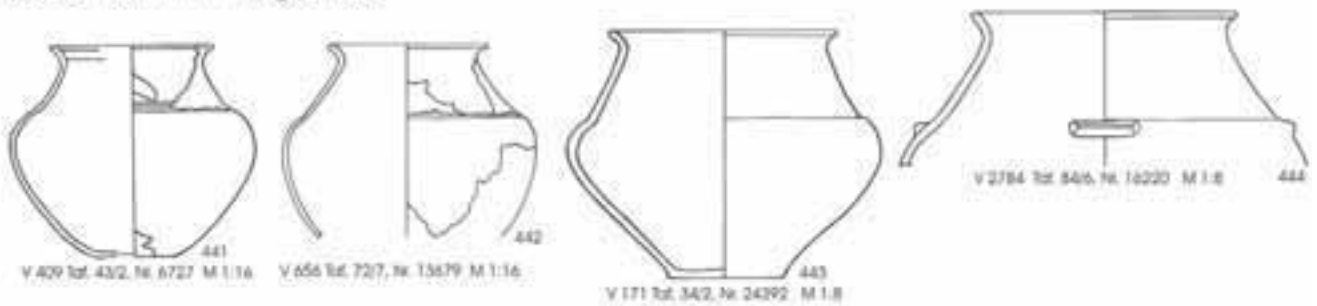

Var.a Relativ hohe Halsgestaltung

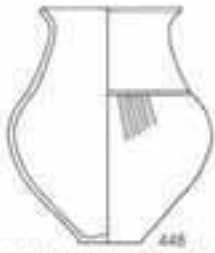

V 868 Taf. 1113/7, Nr. 23511 M 1:16

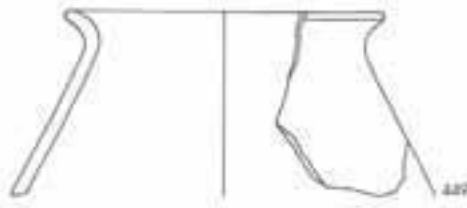

V 841/vM Taf. 1106, Nr. 19137 M 1:4

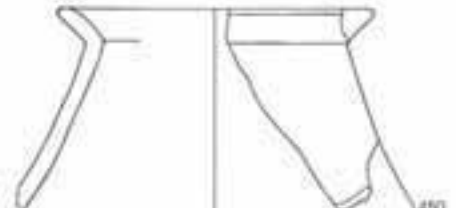

V 843 Taf. 71/1 Nr. 12746 M 1:4

Var. b Relativ hohe Halsgestaltung, optisch enge Halsgestaltung



V 121 Taf. 21/5, Nr. 4128 M 1:4



V 486 Taf. 48/5, Nr. 30004 M 1:4



V 573 Taf. 60/9, Nr. 11505 M 1:8

Var. c Hohe Halsgestaltung, unterrandständige Kannelur

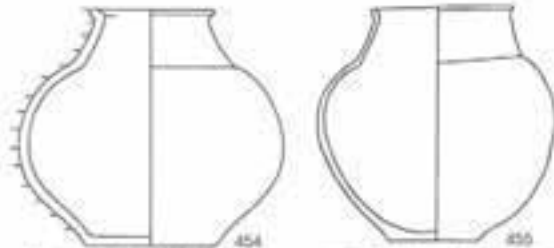

V 2784 Taf. 84/5, Nr. 16090 M 1:8

V 29 Taf. 9/1, Nr. 30040 M 1:8



V 841/1 Taf. 105/2, Nr. 18078 M 1:4

Var. d Relativ niedere, optisch enge Halsgestaltung

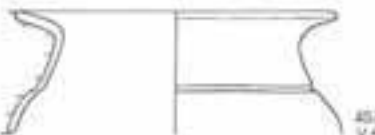

V 548 Taf. 72/1, Nr. 13761 M 1:8

Var. e Relativ niedere, optisch breite Halsgestaltung

Typ D Form mit gut abgesetztem Kegelhals

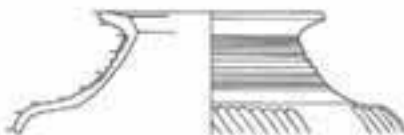

V 777 Taf. 82/4, Nr. 19711 M 1:8

Var. a Relativ hohe, optisch enge Halsgestaltung

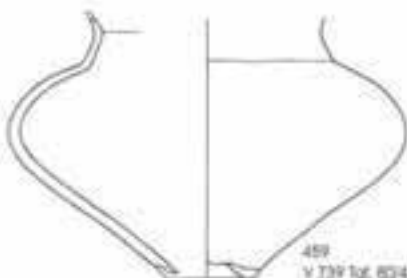

V 739 Taf. 82/4, Nr. 15847 M 1:8

Var. b Relativ niedere, optisch breite Halsgestaltung

Typ E Rand- und Halsstücke von mittelfeinen Hochformen

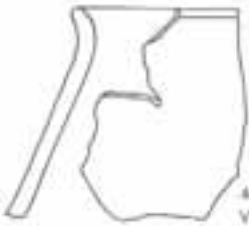

460
V 834 lat. 101/1, Nr. 21045 M 1:4

Vord. Kurz ausblegender Rand



V 487/1 lat. 45/7, Nr. 8926 M 1:4
461



V 523 lat. 55/2, Nr. 8752 M 1:4
462

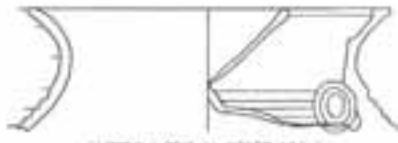

V 792 lat. 92/3, Nr. 30122 M 1:4
463

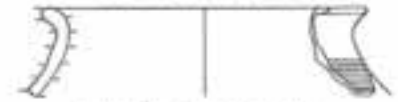

V 198 lat. 37/1, Nr. 5056 M 1:4
464

Vord. Ausladender Rand



V 656 lat. 72/8, Nr. 13720 M 1:4
465



V 204 lat. 39/8, Nr. 4287 M 1:4
466



V 833 lat. 93,6, Nr. 20222 M 1:4
467

Vord. trichterförmig ausladender Rand



V 813 lat. 95/1, Nr. 20010 M 1:4
470



V 841/vM lat. 112/4, Nr. 19249 M 1:4
469



V 690 lat. 74/11, Nr. 10024 M 1:4
468

Vord. Innen abgesetzt trichterförmig ausladend



V 133 lat. 29/5, Nr. 3066 M 1:4
471

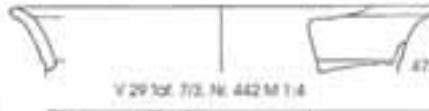

V 29 lat. 7/2, Nr. 442 M 1:4
472



V 487/1 lat. 45/8, Nr. 6226 M 1:8
473



474
V 176 lat. 36/1, Nr. 8143 M 1:4

Vord. trichterförmig



V 868 lat. 113/10, Nr. 21642 M 1:4
475



476
V 29 lat. 7/2, Nr. 14060 M 1:4

Vord. Waagrecht ausladender Rand



V 690 lat. 74/9, Nr. 15069 M 1:4
477



V 128/2 lat. 27/2, Nr. 1794 M 1:4
478

Vord. Innen abgesetzt waagrecht ausladender Rand



V 29 lat. 7/6, Nr. 14105 M 1:8
479



V 164 lat. 33/5, Nr. 4414 M 1:8
480



V 641/vM lat. 109/8, Nr. 19347 M 1:4
481



482
V 591 lat. 63/5, Nr. 14603 M 1:4

Vord. Innen zweifach abgesetzter trichterförmig ausladender Rand

Typ F Form mit zylindrischer Halsgestaltung (Zylinderhalsgefäße)

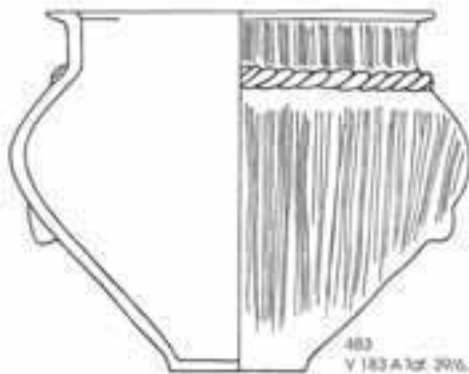

483
V 183A fol. 296, Nr. 30200 M 1:8

Var.a Breite niedere Halsgestaltung mit abgesetzt waagrecht ausladendem Rand



484
V 628 fol. 69r, Nr. 12902 M 1:4

Var.b Breite niedere Halsgestaltung mit innen abgesetzt trichterförmig ausladendem Rand

FLASCHEN

Typ A Formen mit Trichterhals (Trichterhalsgefäß)



485
V 786 fol. 89/13, Nr. 23477 M 1:8



486
V 643 fol. 70r, Nr. 13571 M 1:8



490
V 136 fol. 324, Nr. 2499 M 1:4



488
V 643 fol. 70r, Nr. 13602 M 1:4



489
V 119 fol. 107, Nr. 4069 M 1:4



489
V 841/1 fol. 105r, Nr. 19261 M 1:4

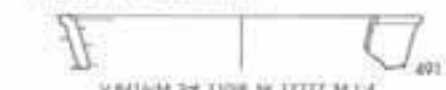

491
V 841/M fol. 110r, Nr. 17777 M 1:4

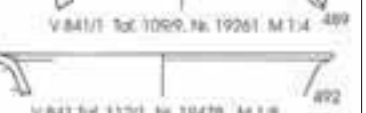

492
V 841 fol. 112r, Nr. 19478 M 1:8



495
V 102 fol. 16/14, Nr. 3988 M 1:4



493
V 687/1 fol. 45r, Nr. 5947 M 1:4

Var.a Innen abgesetzter trichterförmiger Rand

Typ B Formen mit kegelförmiger Halsgestaltung

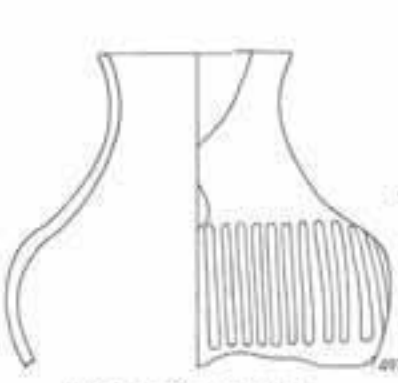

497
V 667 fol. 73r, Nr. 13134 M 1:4

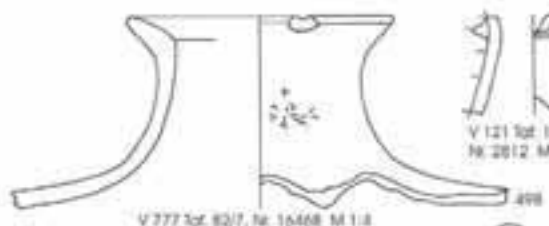

498
V 777 fol. 82/7, Nr. 16468 M 1:8



499
V 121 fol. 192, Nr. 2612 M 1:4



500
V 28 fol. 97, Nr. 30031 M 1:4



501
V 750 fol. 81r, Nr. 15776 M 1:8



502
V 204 fol. 40/3, Nr. 4310 M 1:4



503
V 871 fol. 114/11, Nr. 22707 M 1:8

Var.a Hoher, optisch enger geschwungen kegelförmiger Hals