

The Velika Gorica cemetery and related sites in Continental Croatia

Snježana Karavanić

Zusammenfassung

DER VELIKA GORICA-FRIEDHOF UND VERGLEICHBARE FUNDORTE IM BINNENLÄNDISCHEN KROATIEN. Der vorliegende Artikel behandelt Grabkontexte aus Velika Gorica (Zagreb). Der Fundort wurde durch Zufall beim Kiesabbau auf dem Grundstück (Kataster-Nr. 380/2) des Geschäftsmanns Nikola Hribar in der Nähe des örtlichen Spitals entdeckt. Es wurden Brandbestattungen sowie mittelalterliche Körpergräber gefunden. Der erste Befund wurde von V. Hoffiller 1909 publiziert. Derselbe Autor analysierte 1924 die Keramikfunde. Die Funde von Velika Gorica lieferten die Definitionsbasis für die jüngere Phase der Urnenfelderkultur in Nordkroatien. Später wurde die Bezeichnung Velika Gorica-Gruppe von Ksenija Vinski-Gasparini eingeführt. Alle erhaltenen Gräber wurden 2009 von Snježana Karavanić publiziert.

Abstract

The article deals with the grave assemblages from the Velika Gorica (Zagreb) site. The site was discovered by chance during pebble quarrying on the cadastral plot no. 380/2, owned by a businessman named Nikola Hribar, and is located near the local hospital. On that occasion, finds from cremation burials, as well as from later, medieval inhumations, were found. The first report was published by V. Hoffiller in 1909. The same author analysed ceramic finds in 1924. The finds from Velika Gorica provided the basis for the definition of the younger phase of the Urnfield culture in North Croatia. Later the term Velika Gorica group was introduced by Ksenija Vinski-Gasparini. All preserved graves were published by Snježana Karavanić in 2009.

1. Introduction

The Urnfield culture in Croatia is represented by grave finds from the entire time span of this culture (fig. 1). Unfortunately, most of the cemeteries were not systematically excavated and they lack closed grave finds and find circumstances. From the early Urnfield culture we have cemeteries at Virovitica and Sirova Katalena, which were excavated in the 60ies by Ksenija Vinski-Gasparini.¹ They formed a basis for the definition of the so-called 1st phase of the Urnfield culture in Croatia and later the Virovitica group. We can also attribute the cemeteries of Moravče², Drljanovac³ and Voćin⁴ to this group. Furthermore, we can mention cemeteries of the Gredani group, excavated by K. Minichreiter in the 80ies,⁵ in a separate group. Some new sites at Mačkovac-Crišnjevi⁶ and Popernjak⁷ can also be attributed to this group, locally called the Barice-Gredani group. The Zagreb-Vrapče⁸ cemetery also belongs to the early Urnfield culture and its phase II.

We attributed cemeteries from Zagreb-Horvati, Velika Gorica, Krupače, Treščerovac⁹ and Ozalj¹⁰ to the late phase of the Urnfield culture. The cemeteries of the Dalj group¹¹ form a separate group.

1. VINSKI-GASPARINI 1973.

2. SOKOL 1990. – SOKOL 1996.

3. MAJNARIĆ PANDŽIĆ 1988. – MAJNARIĆ PANDŽIĆ 1994.

4. LOŽNJAK 2003.

5. MINICHREITER 1983.

6. MIHALJEVIĆ, KALAFATIĆ 2004.

7. MARIJAN 2005.

8. VINSKI-GASPARINI 1973.

9. VINSKI-GASPARINI 1973.

10. BALEN-LETUNIĆ 1981.

11. METZNER-NEBELSICK 2002.

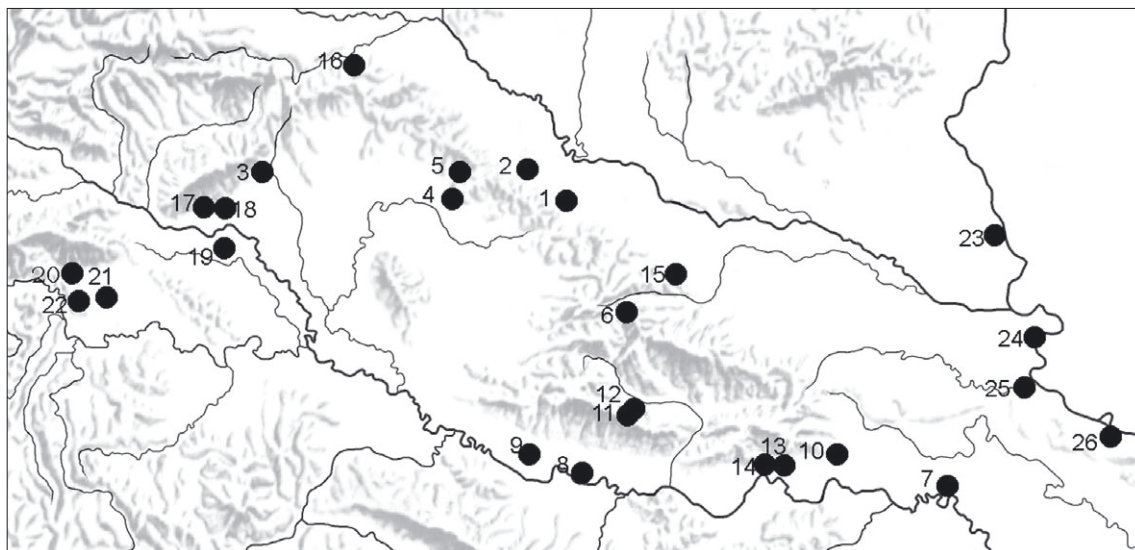

Fig. 1. Map of the Urnfield culture cemetery sites in continental Croatia. 1. Virovitica – 2. Sirova Katalena – 3. Moravče – 4. Drljanovac – 5. Mala Pupelica – 6. Voćin – 7. Popernjak – 8. Mačkovac-Crišnjevi – 9. Gredani – 10. Perkovci-Dobrevo – 11. Slavenska Požega-Bajer – 12. Grabarje (Slavonska Požega) – 13. Vranovci (Slavonski Brod) – 14. Oriovac (Slavonski Brod) – 15. Nova Bukovica (Podravska Slatina) – 16. Ludbreg – 17. Zagreb-Vrapče – 18. Zagreb-Horvati – 19. Velika Gorica – 20. Krupače – 21. Treščerovac – 22. Ozalj – 23. Batina – 24. Dalj – 25. Vukovar-Lijeva Bara – 26. Šaregrad.

2. Location of the site

The area investigated covers today's administrative units of Zagreb and Karlovac county. The site (fig. 2) is located right in the middle of the present day town of Velika Gorica, which was formerly a suburb of Zagreb. It is 10 km away from Zagreb and lies on the territory south of the river Sava. In prehistory it was exposed to different cultural influences, both from the Balkans as well as Pannonia and the Eastern Alpine region. Velika Gorica and Dobova lie on the natural pass from the lower to the upper Sava valley. Dobova is only 37 km linear distance from Velika Gorica. This territory is located between the mountains Medvednica, Žumberak and Samoborsko gorje and we have evidence for several hill-fort sites from the Late Bronze Age and Early Iron Age on their slopes like Susedgrad, Sv. Križ Brdovečki and Bregana-Kosovac.¹²

3. History of the research on the Velika Gorica cemetery

The first report was written by V. Hoffiller,¹³ who described and analysed the finds of 20 graves (15 cremation graves in urns and 5 inhumations) that were discovered in 1908.

The site was discovered during the pebble quarrying on the cadastral plot no. 380/2, owned by a businessman named

Nikola Hribar, and located near the local hospital.¹⁴ On that occasion, finds from cremation burials, as well as from later, medieval inhumations, were found. It is mentioned that urn graves were also found on the cadastral plot no. 543.¹⁵

The information from the museum's archives¹⁶ informs us that during 1909, and under the direction of the Archaeological Museum in Zagreb, 16 graves were found, and a further 14 were discovered the following year. In 1910 T. Kalčić found 7 graves, and in 1916 an additional 6. During 1910, 1911, 1914, and 1924 the Museum received additional finds from the Velika Gorica cemetery as a gift from the owner of the land. A total of 67 graves, most of them cremation burials of prehistoric age, were excavated. However, there were some from the Roman period, as well as 6 inhumations from the medieval period.

In 1924 V. Hoffiler published a paper on the prehistoric urns from the site in the Frane Bulić Festschrift (Serta Buliciana).¹⁷

The finds from Velika Gorica were also published by him in the *Corpus Vasorum Antiquorum* series.¹⁸

12. VRDOLJAK 1996.

13. HOFFILLER 1909.

14. HOFFILLER 1909, 120.

15. HOFFILLER 1909, fig. 17.

16. V. Vejvoda, Prehistorijsko nalazište Velika Gorica (archives of the Archaeological Museum in Zagreb).

17. HOFFILLER 1924.

18. HOFFILLER 1938.



Fig. 2. Map with the location of the Velika Gorica and Dobova sites.

They also appear in the list of the Archaeological map of Yugoslavia under the name of Velika Gorica, *Blatt Zagreb*.¹⁹

The first catalogue of chosen grave assemblages from the Velika Gorica cemetery was published by F. Staré²⁰ and was analysed by him the same year in his paper on semilunar razors from Yugoslavia.²¹

K. Vinski-Gasparini²² included the finds in her synthesis, but chose not to do a detailed analysis of the finds from the late period of the Urnfield culture, as they had already been previously published. K. Vinski-Gasparini²³ published 5 graves: 7/1908, 1/1910, 2/1910, 1/1911 and 3/1916.

In our work, we have chosen to do a detailed analysis of the complete inventory from the site that is housed in the Archaeological Museum in Zagreb. Graves were analysed according to their description in the inventory books, and an attempt was made to reconstruct the previously unreconstructed grave associations. Our analysis also added new items to the grave contents published by V. Hoffiller²⁴ and

K. Vinski-Gasparini²⁵ (1973). All of the preserved graves at Velika Gorica were published by the author of this article in 2009.²⁶

4. The reconstructed number of the graves

We divided the graves into those known only from descriptions in the literature (fig. 3), those with the known material that is housed in the Archaeological Museum in Zagreb, and those graves that we assume might have also been excavated (blue colour). From our work on the material from Velika Gorica it is assumed that a total of 53 urn graves from the prehistoric age could be registered, but only 22 could be reconstructed as closed grave finds, 19 are known from the literature and the remaining 12 graves are only assumed to have been excavated.

5. Burial rites

The only data about the type of cremation burials at Velika Gorica come from V. Hoffiller's report²⁷ about the excavation of 9 urn graves at the aforementioned cadastral plot 380/2 owned by Nikola Hribar. All of these graves were found at a depth of 40–50 cm, except grave 1 which

19. KLEMENC 1938.

20. STARÉ 1957a.

21. STARÉ 1957b.

22. VINSKI-GASPARINI 1973.

23. VINSKI-GASPARINI 1973.

24. HOFFILLER 1909.

25. VINSKI-GASPARINI 1973.

26. KARAVANIĆ 2009.

27. HOFFILLER 1909.

1908	1910	1911	1914	1916
1. 1/1908	15. 1/1910	36. 1/1911	47. 1/1914	48. 1/1916
2. 2/1908	16. 2/1910	37. 2/1911	46. 2/1914	49. 2/1916
3. 3/1908	17. 3/1910	38. 3/1911	47. 3/1914	50. 3/1916
4. 4/1908	18. 4/1910	39. 4/1911		51. 4/1916
5. 5/1908	19. 5/1910	40. 5/1911		52. 5/1916
6. 6/1908	20. 6/1910	41. 6/1911		53. 6/1916
7. 7/1908	21. 7/1910	42. 7/1911		
8. 8/1908	22. 8/1910	43. 8/1911		
9. 9/1908	23. 9/1910	44. 9/1911		
10. 10/1908	24. 10/1910	45. 10/1911		
11. 11/1908	25. 11/1910	46. 11/1911		
12. 12/1908	26. 12/1910			
13. 13/1908	27. 13/1910			
14. 14/1908	28. 14/1910			
	29. A/1910			
	30. B/1910			
	31. C/1910			
	32. D/1910			
	33. E/1910			
	34. F/1910			
	35. G/1910			

□ graves known from literature

□ graves with known material

□ supposed graves

Fig. 3. Table with the preserved and non-preserved grave finds at Velika Gorica.

was found at a depth of 80 cm. They were all buried in the pebble soil. V. Hoffiller mentions that all the 9 graves were at the same place, at a distance of 3 m from each other. The soil around each grave, about 1 m², was very dark and black and mixed with charcoal. I assume that this was probably the traces of burial pits. The statement that the urns were very small vessels, rarely covered with another small vessel, is very important information from this report. The burnt bones were mostly found around the vessels, but it is possible that there were examples with bones inside the urns. Items made of metal were also located near the urn.²⁸ As in the case of the finds from Krupače and Treščerovac, it was not possible to preserve all the urns, due to the poor quality of the pottery, as well as the humidity of the soil. It is also worth mentioning that the vessels that we called urns did not always serve as a container for cremated bones. They actually have very small dimensions and have usually a hole on the vessel walls.

We can take the results of the excavation of the Dobova cemetery, just across the border in Slovenia, as a parallel to the Velika Gorica cremation burials. The graves are dug into the same alluvial Sava pebble soil. F. Staré²⁹ distinguished three groups of graves there:

1. The first group are the graves with the bones inside

the urn, which was placed into the grave pit. Grave goods are very rare in this group and are mostly placed in the urn.

2. The second group are the graves with a vessel-urn. But the bones are placed on the bottom of the pit together with charcoal. Grave goods are most frequent in this group and were placed in the urn as well as beneath it on the bottom of the grave pit.

3. The third group are the graves without urns and only with bones inside the grave pit with charcoal. The grave goods were mostly some pieces of pottery.

We have evidence of the existence of large vessels or urns inside which small vessels were placed together with cremated bones and grave goods from the cemetery of Krupače.³⁰ The urns were found at a depth of 40 cm beneath the surface. Some were covered with a small bowl, and inside the urns, on the layer of ashes, a small pot also covered with a bowl was found. Inside this small pot there were cremated bones and a rare piece of metal. J. Brunšmid also mentions an example of a small urn, with cremated bones inside it and metal grave goods beside it, beneath the layer of burnt soil.

For the Treščerovac³¹ cemetery we also have some data from the Šime Ljubić report from 1885, where it is stated that 46 urns were found in an area with a length of 21 m and a width of 11.5 m. Some urns were placed 50 cm beneath the surface, some 1 m and some right beneath the surface. Four

28. HOFFILLER 1909, 122.

29. STARÉ 1952. – STARÉ 1975.

30. BRUNŠMID 1898.

31. LJUBIĆ 1885.

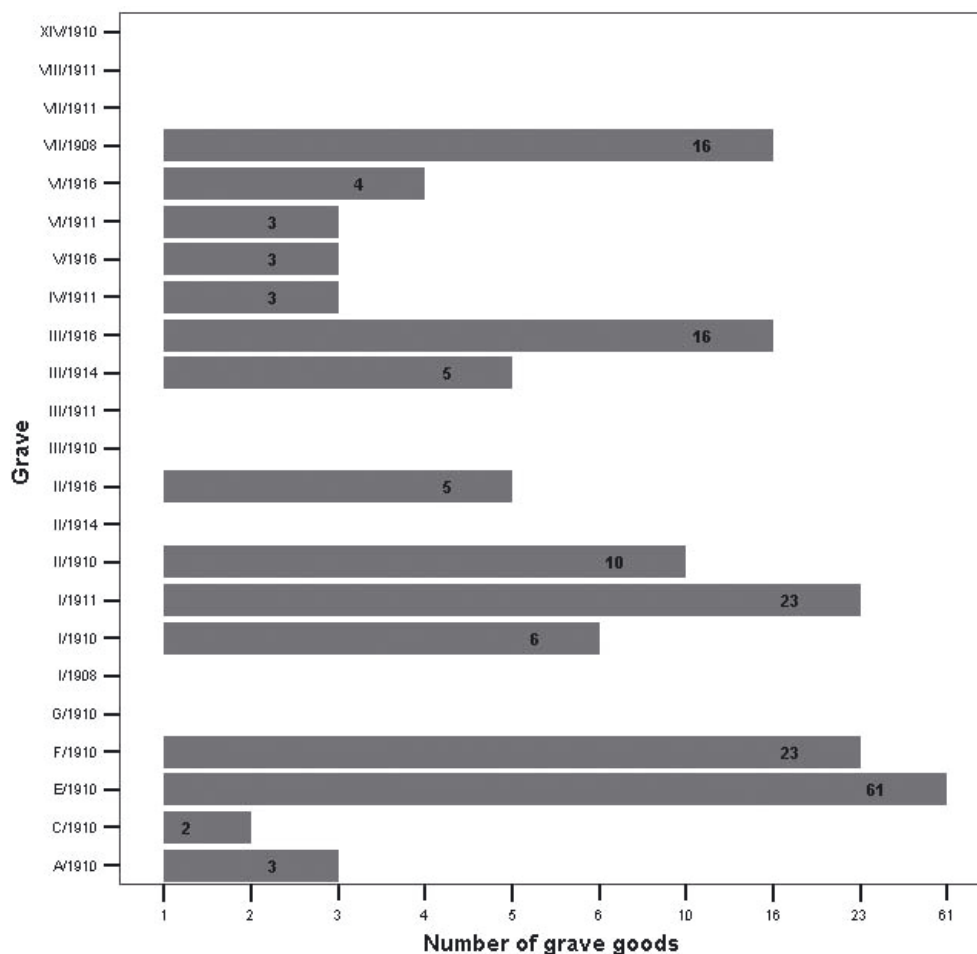

Fig. 4. The number of finds in the Velika Gorica graves.

urns had a stone slab cover, one had a double stone slab and the others had a bowl as a lid. The same applied at Krupače, a small urn and cup could be found inside the big vessel. Only in one case was this small urn outside but near the big vessel. Š. Ljubić assumed that a total of 130 vessels were found. Š. Ljubić also stated that it is possible that these urn graves were used for burying two or three persons because cremated bones fill half of one big urn and were also found in some small vessels. Unfortunately we do not have any anthropological data from these graves. It is also interesting that Š. Ljubić reports about the existence of places where the cremation might have taken place. These places were near the urns, about 50 cm away from them and that was the evidence for a cremation ceremony performed on the same cemetery.

At Ozalj Balen-Letunić³² distinguished several types of graves:

1. A grave pit with the urn covered with a bowl or other vessel. The ashes and cremated bones are placed into the urn.
2. A grave pit dug into the bedrock with stone covering and with the same type of urn. The cremated bones are inside or outside of the urn.
3. A grave pit with traces of cremated bones and ashes and a ceramic bowl as a grave good.

6. The number and structure of grave goods from Velika Gorica

6.1 The number of grave goods per grave

The richest of the Velika Gorica graves is grave E/1910 (fig. 4) containing over 30 finds. However, we include vari-

32. BALEN-LETUNIĆ 1981.

ous fragments that could not be reconstructed accurately (except in rare cases) in this number, making it larger than it actually is.

A similar situation is seen in the case of grave F/1910 with over 20 finds. A somewhat more realistic situation is observed in graves 7/1908, 1/1911, and 3/1916 as those contain a smaller number of fragments. Therefore, these three latter graves should be considered the richest of the Velika Gorica graves. In them, the grave goods are mostly bronze tools and weapons, and some decorative items. With fewer goods, but still quite rich in goods (between 5 and 10) are graves 3/1914, 1/1910, A/1910, 5/1908, and 2/1910, while in other graves fewer than 5 objects were found.

6.2 The number of grave goods at Velika Gorica

A total of 296 items or grave goods is present in the Velika Gorica assemblage. It can be compared with the Dobova cemetery where we counted a number of 732 grave goods (fig. 5). It has to be noted that in this analysis all of the items were included, not just the ones for which the grave affiliation is known. This can present a methodological problem and further enlarges the item list.

We have defined 20 variables that represent different types of items at the Velika Gorica cemetery. These are:

- 1 pin
- 2 necklace
- 3 bracelet
- 4 bronze ring
- 5 hair ring
- 6 spectacle fibula
- 7 fibula
- 8 fibula of passementerie style (*Posamentierfibel*)
- 9 bead
- 10 decorative plate
- 11 razor
- 12 sword
- 13 spear
- 14 knife
- 15 socketed axe
- 16 weight
- 17 spindle whorl
- 18 ceramic bowl
- 19 rivets
- 20 whetstone

The most abundant grave good type in Velika Gorica is bracelets (fig. 6) (a total of 96 bracelets were found in closed grave associations). The second most abundant type is ce-

ramic vessels (type 18), and necklaces (type 2). Both items are represented by 32 finds.

It has to be noted that some graves contained a single vessel, broken into pieces, and could represent an urn containing the remains of a cremation. The other possibility is that it represents a vessel that was put into the grave as a grave good and not as an urn. Cups and bowls are the most common type of grave goods, while pots, especially those with a hole, were used as urns. After these, the most abundant finds are spectacle fibulae (type 6), of which 20 were found, albeit mostly in fragments. Of other common types 18 spindle whorls (type 17) were found at the cemetery, 16 hair rings with an interwoven design (type 5), and 14 weights (type 16). 12 bronze rings (type 4) and 10 knives were also found. Other finds vary in their abundance from 1 to 8 pieces.

6.3 Comparison with Dobova

At Dobova,³³ the most abundant items are ceramic vessels (fig. 7), of which about 500 were found, followed by a hair ring with an interwoven design, pins, and bracelets.

Compared to these, the rest of the item types appear in small quantities, about 10 per item. The two sites are most similar according to the number of bracelets found, while some types that are found at Velika Gorica, such as passementerie fibulae and razors, are not found at Dobova at all.³⁴ Comparing the cumulative curves of the items found at Dobova and Velika Gorica, there are clearly differences in the percentages of the various types of items. A significant rise is seen in Velika Gorica in necklaces, while the next rise appears for the bracelets and again for the spectacle fibulae.³⁵

The cumulative curve (fig. 8) for the Dobova material³⁶ is moderately rising to the spindle whorls except for the hair decorations that are somewhat more abundant in comparison to the other finds.

Ceramic vessels are the most abundant as can be seen in a drastic rise of the values on the curve. This also shows the differences between the sites. At Velika Gorica necklaces, bracelets and spectacle fibulae are most abundant. Biba Teržan³⁷ published a graphic comparison of the cemeteries from Slovenia: Dobova, Ruše and Podbrežje according to metal objects, graves containing ceramic items, and graves without grave goods. It can be seen that at Pobrežje and Ruše a similar number of graves containing metal ob-

33. KARAVANIĆ 2000, fig. 4.

34. KARAVANIĆ 2000, 42.

35. KARAVANIĆ 2000, 43.

36. KARAVANIĆ 2000, fig. 6.

37. TERŽAN 1999, fig. 9 a, b.

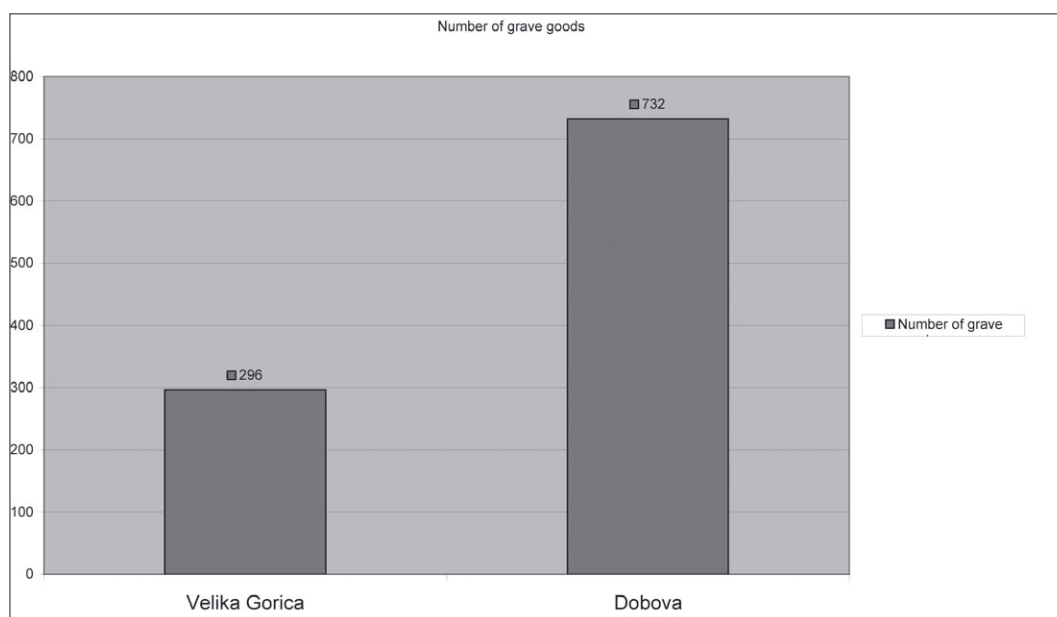

Fig. 5. Comparison of number of finds at Velika Gorica and Dobova.

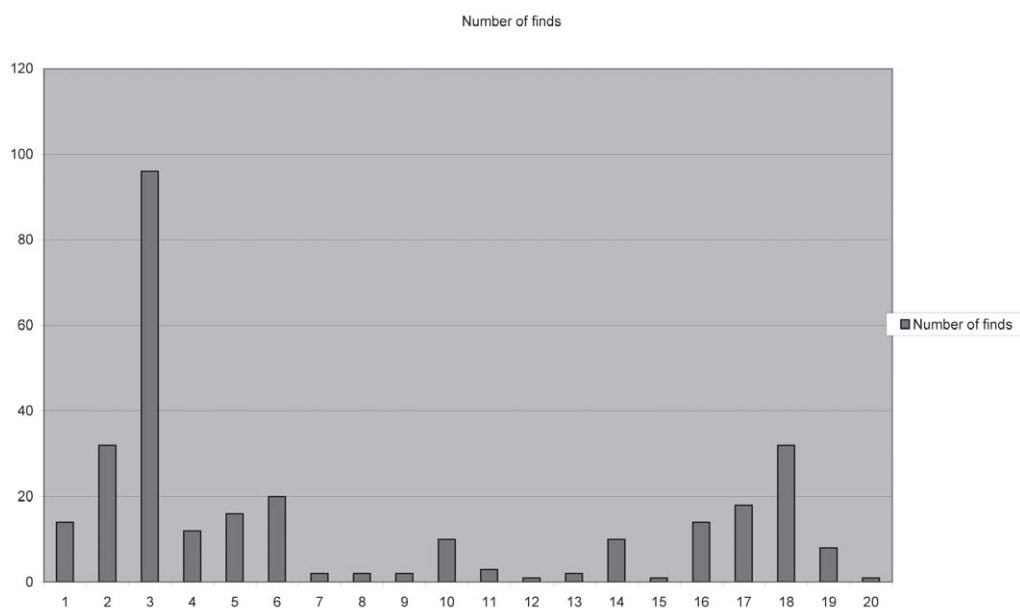

Fig. 6. The number of different types at Velika Gorica.

jects were discovered, while Dobova has fewer graves with metal objects. Graves with ceramics are most common at Podbrežje, Dobova comes second, while at Ruše these are less frequent. Dobova has the most graves that contain no grave goods, and that makes it different from Velika Gorica, which has lots of grave goods.

7. Pottery types

The most characteristic finds of the Velika Gorica cemetery are the urns themselves. These appear in several forms. They mostly have the form of a vessel with a single hole in its middle part. This is, except for the cemetery at Dobova and a few finds from Tolmin, a unique characteristic of this site compared to other sites in the southern Alpine region. This type of urn is found in graves 2/1910, 3/1910, G/1910,

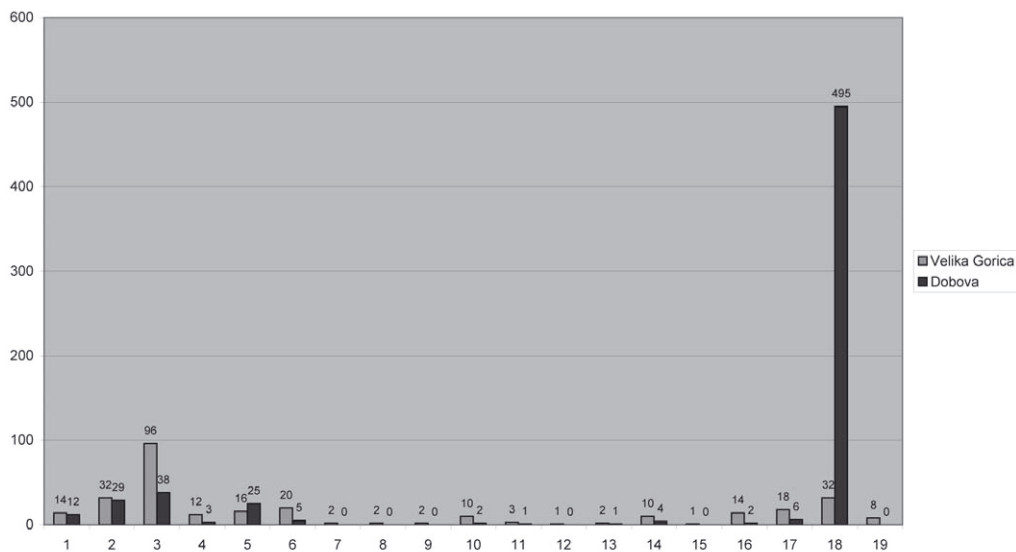

Fig. 7. The comparison of number of types between Velika Gorica and Dobova.

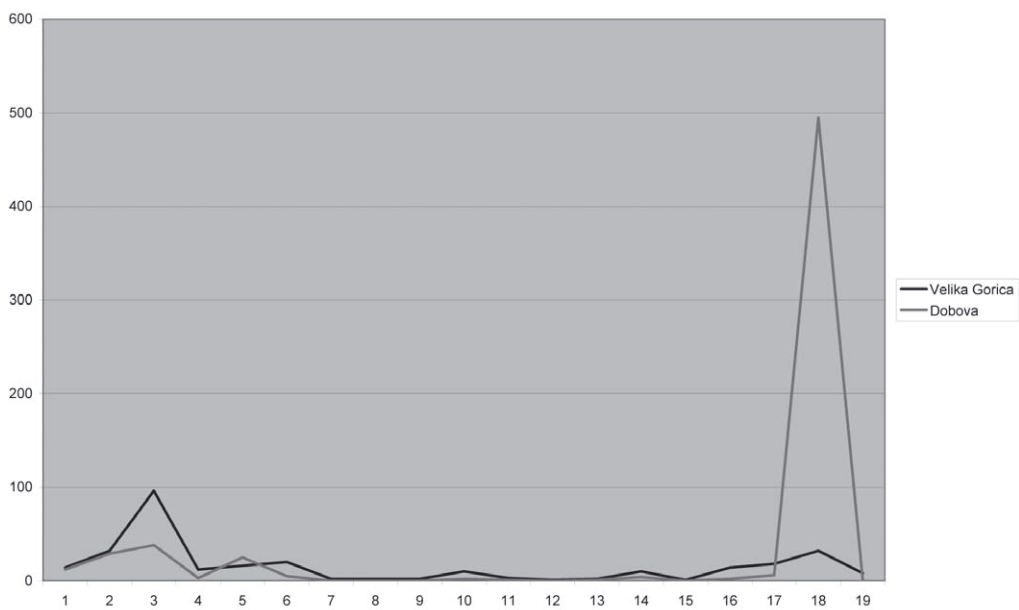

Fig. 8. Curve graph with a comparison between Velika Gorica and Dobova.

4/1911, and 7/1911. K. Vinski-Gasparini³⁸ points to analogies with younger forms seen in the Baierdorf-Velatic culture and some of the Dobova urns, and at the same time points to the find of a rounded bowl from Zagreb Vrapče grave 4, in which she sees the origins of the Velika Gorica

type of urns.³⁹ She also points to a link with the finds from the Virovitica site.⁴⁰

These urns with a hole were previously discussed by V. Hoffiller,⁴¹ who at first argued that the holes had a practical purpose. This is unlikely as the vessels would fall apart

38. VINSKI-GASPARINI 1973, 155.

39. VINSKI-GASPARINI 1973, t. 25/1.

40. VINSKI-GASPARINI 1973, t. 9/9; t. 14/5.

41. HOFFILLER 1924, 3.

if hung. He has published all of the 14 vessels with holes as well as two additional ones that were too damaged to tell whether they had holes or not.⁴² As V. Hoffiller⁴³ states, the most abundant form of these urns is a rounded or globular vessel with a straight base. This basic form has several varieties, some vessels being flatter, others narrower and taller, while those that are widest at the rim are also found. One urn, in particular, is important as far as its dimensions and form⁴⁴ are concerned, as it has a slightly biconical part in the middle. The form is reminiscent of the younger period of the Velatice culture. One urn has a reconstructed rim. Urns are quite diverse regarding size, ranging from a height of 8.2 cm to 19 cm. The wall thickness varies from 0.5 to 1 cm – which is quite thick. Holes are mostly round, in some cases slightly oval in form, with a diameter of 1.8 to 2.8 cm. Holes are located from about 2 cm below the rim, and in some urns they are situated lower, as in the case of the largest one in which the hole is located about 9 cm below the rim.⁴⁵

V. Hoffiller⁴⁶ compares the urns from Velika Gorica to the urns in the shape of a house (*Hausurnen*), a form that makes its appearance in the Late Bronze Age and can be found at early Iron Age sites in Italy and Germany. He calls them “*shrunken urns in the shape of a house*” that, according to him, were used to bury poor people. This is an oversimplistic view and is in contrast to the situation found at Velika Gorica, where numerous quite rich graves have been discovered. Analogies with this type of urn can be seen at Dobova, for example in grave no. 13 from that site.⁴⁷ In grave no. 16 at Dobova a variant of this type appears which has a half-opening at the rim of the vessel.⁴⁸ Likewise, in grave no. 29, a variant of a bowl with a straight rim and a hole in the middle was found.⁴⁹ In Dobova grave no. 77⁵⁰ is dated to Ha B1, on the basis of a pin of the Pile dwelling type, as is the urn with a hole in the middle. An interesting find comes from grave no. 90 from Dobova⁵¹ where a pin of the Velemszentvid type was found. This type is also found at the Kalnik-Igrišće I site⁵² and can be dated to the earlier phase of the Urnfield culture. Although Dular⁵³ dates this grave to

the earlier phase of the Velika Gorica group, based on the find of a bowl with an inverted rim with facettes on it,⁵⁴ a somewhat earlier date might be appropriate. This could also mean that the urns with holes are somewhat older. Another find of urns with holes comes from the cemetery of Tolmin, grave 13⁵⁵, grave 43⁵⁶ and grave 215⁵⁷. D. Svöljšak and A. Pogačnik⁵⁸ find parallels at the cemetery of Dobova and cite F. Staré’s opinion that these holes had cultic significance. The holes were meant to be a kind of recipient for the soul of the buried deceased, a so-called *Seelenloch*.

Vessels with two handles (*amphorae*) are also found at Velika Gorica.⁵⁹ This type of vessel is found in almost all of the groups of the younger phase of the Urnfield culture. It is also found in several graves at Dobova: grave no. 5⁶⁰, grave no. 7⁶¹, grave no. 119⁶² etc.

We also find a deep bowl with an S-profile, decorated with fluting on the belly. It has analogies in the finds from Zagreb-Horvati,⁶³ once more confirming the dating of this site to the late phase of the Urnfield culture.

At Velika Gorica, a vessel decorated with the so-called *Pseudoschnur* ornament is also found. Analogies can be seen at Ruše and among the finds from grave 35 from Podbrežje.⁶⁴ A similar decorative motif is seen on the bowl from destroyed grave assemblages with direct analogies to the vessel found in grave no. 8/1993 from the Ruše II site,⁶⁵ dated to the Ha B3 phase. This type of decoration would confirm that the Velika Gorica group lasted into the Ha B3 period and provides the link between the region of the upper Sava river and the region near the Drava river. K. Vinski-Gasparini⁶⁶ argued that this vessel should be dated to the Ha B1 period and the earliest phase of the Ruša group.

Two cups have been found at the Velika Gorica cemetery. The first one has a slightly biconical body form and a high handle, while the other has a rounded body and a strap handle that exceeds the rim of the vessel. Analogies are found at the Dobova cemetery: grave no. 11⁶⁷, grave no. 77 in

42. HOFFILLER 1924, t. 1.

43. HOFFILLER 1924, 4.

44. HOFFILLER 1909, t. 1/10.

45. HOFFILLER 1909, t. 1/10.

46. HOFFILLER 1909, 7.

47. STARÉ 1975, t. 7/2.

48. STARÉ 1975, t. 8/5.

49. STARÉ 1975, t. 9/18.

50. STARÉ 1975, t. 15/10–12.

51. STARÉ 1975, t. 16/11–14.

52. MAJNARIĆ-PANDŽIĆ 1992, t. 2b/12.

53. DULAR 1978.

54. STARÉ 1975, t. 16, 12.

55. SVOLJŠAK, POGAČNIK 2001, t. 2/7.

56. SVOLJŠAK, POGAČNIK 2001, t. 9/8.

57. SVOLJŠAK, POGAČNIK 2001, t. 38/9.

58. SVOLJŠAK, POGAČNIK 2002, 82.

59. KARAVANIĆ 2000, t. 21/1; t. 29 and 1, t. 30/3.

60. STARÉ 1975, t. 5/13.

61. STARÉ 1975, t. 7/11.

62. STARÉ 1975, t. 20/4.

63. VINSKI-GASPARINI 1973, t. 93/2.

64. PAHIĆ 1972, t. 8/5.

65. ČREŠNAR 2006, t. 2B/1, 146.

66. VINSKI-GASPARINI 1973, 155.

67. STARÉ 1975, t. 6/13.

which a pin of the pile dwelling type was found,⁶⁸ allowing its dating to the Ha B1 period.

8. Metal items

In spite of the unclear circumstances of the discovery, the numerous metal objects from Velika Gorica cemetery are important.

Hair decorations and hair rings with an interwoven design are considered very important inventories of female burials of the Ha B period of the Urnfield culture in Slovenia.⁶⁹ Listing the finds from Ruše, Pobrežje, Zgornja Hajdina, Radvanje, Duplice i Mokronog, F. Staré also emphasizes the similarity of the finds from Velika Gorica to those from Dobova. F. Staré distinguishes between two types, based on the form of the interwoven design. One type has a proper interwoven design⁷⁰, while the wire of the other type is folded into U-knots.⁷¹ F. Staré ascribed the finds from Velika Gorica to the second type. In grave no. C/1910 a hair decoration of the second type was found, while in grave no. 2/1914 one belonging to the first type is present. In grave no. 3/1916 a hair decoration of the second type was found, while that from 6/1916 cannot be assigned to a particular type due to the poor state of preservation. A second type was also found outside grave assemblages. F. Staré⁷² links these hair decorations, especially the ones of the second type, to the so-called *pasementier* style or *Posamentier-Stil* and, based on the finds known at that time, concludes that the river Sava in Slovenia was the westernmost boundary of this decorative style. However, this type of hair decoration is found in some of the hoard finds, for example in the Bingula-Divoš hoard⁷³. These decorations are also found in the Brodski Varoš hoard,⁷⁴ and Mačkovac or Mačkovac I hoard⁷⁵. Such items are characteristic of female burials (in a sense of grave good items, not in the anthropological character of graves) like those at Velika Gorica, for which a large number of necklaces, bracelets, fragments of fibulae, as well as numerous spindle whorls, clay and pyramidal weights that are put in female graves alongside cremated remains, are characteristic grave goods, examples are grave E/1910, grave F/1910, and grave 3/1916. In grave E/1910 all the metal items were preserved in a fragmented state. 61 fragments belonging to

different items were found. Fragments of hair decoration were also found but it is unclear to which type they belong.

The dominant type of fibula is the *spectacle fibula* that appears in graves 2/1914, 1/1910, 2/1910, E/1910, 3/1916, as well as in the inventory of destroyed graves. The type is represented as small spectacle fibula with a figure of eight loop. According to F. Staré's analysis of grave 108 from Dobova they were introduced at the beginning of the Ha B1 period and continued to appear in other periods of the late Urnfield culture. This is the Haslau-Regelsbrunn type. In graves 4/1911 (fig. 9) and E/1910 we have documented parts of possible similar variants of *Posamentierfibeln*, that could be connected with the fibula at Pobrežje in Slovenia, grave 127.⁷⁶

Another type of fibula is the so-called *saddle like fibula* from grave 2/1910, which has parallels to graves 78 and 110 from Ruše, dated to the Ha B2 period. The same fibula is known from the Kalakača settlement in Serbia, published by Professor Medović.⁷⁷ In grave 3/1916 a part of a *harp fibula* was found, probably of the Hadersdorf type, but in grave E/1910 we also have part of spiral folded wire that could be connected to this type of fibula but we are not sure because of the small fragments. One fragment of a fibula probably comes from a saddle-like type, also from destroyed graves. Other examples are probably part of a *bow* or *arc fibula*.

Pins are quite a common type of attire in the Velika Gorica graves, both male and female. We have so-called Pile dwelling type pins dated to period Ha B1 and also pins with bulb head sometimes with a thickened and twisted neck like the ones from grave 3/1910 and a similar one from grave G/1910. The one from grave 3/1910 has parallels from grave 6 at Dobova.

Twisted torcs were found in numerous fragments. It can be deduced that this item was one of the most common grave goods at the Velika Gorica cemetery. This type of necklace appears in hoards of period II of the Urnfield culture, such as the Otok-Privlaka, Poljanci I, Brodski Varoš, Pričac, and Mačkovac hoards. A fragment is also found in the Ivanec Bistranski hoard, while two fragments come from the Kamena Gorica hoard. A complete one was found in the Matijevići hoard. Twisted necklaces are abundant at the Dobova and Pobrežje cemeteries. They also appear, but less frequently, at the sites of Ruše and Hajdina.⁷⁸ They are associated sometimes with spectacle fibulae as seen on the female attire reconstruction (fig. 10).

Hair decoration of an undeterminable type was found

68. STARÉ 1975, t. 15/11.

69. STARÉ 1960, 85.

70. STARÉ 1960, fig. 8/5.

71. STARÉ 1960, fig. 9/4.

72. STARÉ 1960, 87.

73. VINSKI-GASPARINI 1973, t. 86/18, 19.

74. VINSKI-GASPARINI 1973, t. 57/55, 56.

75. VINSKI-GASPARINI 1973, t. 73/27.

76. PAHIČ 1972.

77. MEDOVIĆ 1988.

78. MÜLLER-KARPE 1959, t. 108–116.

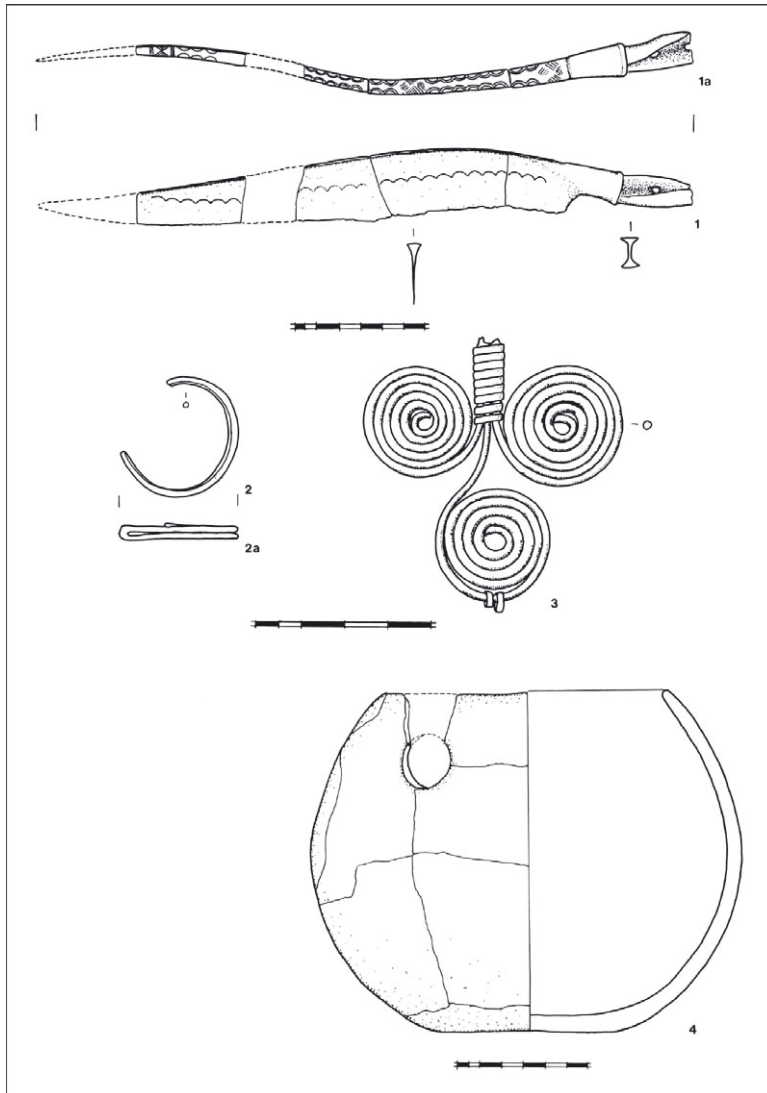

Fig. 9. Grave 4/1911 from Velika Gorica.

in grave F/1910, as well as an undecorated necklace with spiral endings, and a bracelet decorated with engraved lines divided into metopae. These are quite common in the graves at Velika Gorica, but are absent altogether at Dobova cemetery. At Podbrežje they are present but either undecorated, or their decoration is somewhat different in motifs than at Velika Gorica.⁷⁹ This type of decoration is found among the finds from destroyed graves, again pointing to a link between Velika Gorica and Podbrežje. This type of bracelet could be considered as specific of the Velika Gorica cemetery, as they have been found in great numbers, even in the destroyed graves.

79. PAHIĆ 1972, t. 9/5, 6.

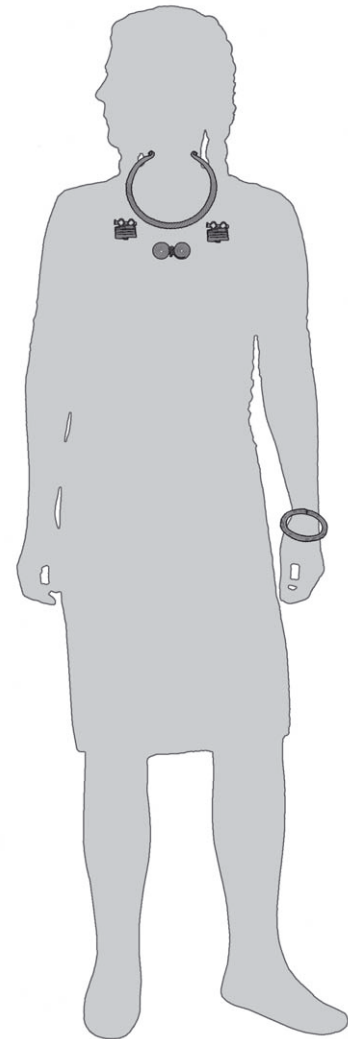

Fig. 10. Female attire reconstruction at Velika Gorica (by Miljenko Gregl).

In grave F/1910 two bronze sheet plaques, that could have been fixed on clothes, were found. In the grave spindle whorls were found, of which the two smaller ones could have belonged to the attire of the female buried in the grave. Spindle whorls were also found in grave 3/1914, alongside a small weight, again pointing to a female burial. Judging by the finds from destroyed graves, spindle whorls were also quite common at Velika Gorica. A decorated weight of pyramidal form was discovered among items from destroyed graves. 2007 Margarita Primas⁸⁰ analyzed spindle whorls from graves. In the inhumation grave 1 from Wiesbaden-

80. PRIMAS 2007.

Erbenheim (period Ha A2)⁸¹ a spindle whorl was found alongside a sword, a knife and a razor. It was found near the left foot of the skeleton. There are no indications that it was a double-burial. There are numerous similarities in the structure of grave goods from this burial and those from grave 1/1911 at Velika Gorica. There, a sword, spear, axe, numerous clay rings, and a spindle whorl were found, suggesting a double-burial. There is not sufficient data on the circumstances of the find, nor on the sex of the deceased (it is a cremation grave), but based on the sword, it was a warrior's grave. M. Primas⁸² states that spindle whorls are more common grave finds after the Ha A2 period. She also presents a map of the distribution of graves with spindle whorls. To these we should add graves from Velika Gorica. M. Primas⁸³ discusses spindle whorls as female grave goods, citing analogies from Italy, where numerous spindle whorls and spools were found in young women's graves (the so-called "weaver sets") at the site of Osteria dell' Osa. In graves of older women, spindles and spindle whorls were often found near the skulls of the deceased. In some areas, spindle whorls are found together with metal jewellery, such as with two pins, suggesting female sex. It can be concluded that most of the spindle whorls come from female graves.

Velika Gorica also has toiletries, in the form of razors, that are found in male graves 1/1911 and 7/1908 and 2/1910. F. Staré⁸⁴ recognizes two types of such razors: one type with a characteristic hunch on the back that is found at sites in Slovenia, and the second type without a hunch found at the sites in Bosnia and Dalmatia. In the same paper F. Staré⁸⁵ gives a first detailed analysis of grave no. 1/1911 from Velika Gorica. F. Staré⁸⁶ dates this grave to the Ha B period and argues for the need of a detailed analysis of the finds from the younger phase of the Urnfield culture. He based his chronology and dating of these razors on the finds from the Grapska hoard from Bosnia, in which a semilunar razor without hunch was found, as well as on the finds from grave I from Tešanj, and the find of a mould for the casting of semilunar razors and socketed axes from Donja Dolina, dated to the Ha B period.⁸⁷ Based on this evidence, F. Staré argues that the earliest appearance of the semilunar razor on the soil of former Yugoslavia (as seen in the finds from grave 1/1911 and the Grapska hoard), dates in the begin-

ning phase of the younger period of the Urnfield culture, in which elements of Ha A can still be observed. Therefore, he dates them to the Ha B1 period. He also argues that this type of razor has its origin within the southwestern Pannonian basin, from where it spread north, to the middle Danube region and southwards, into Italy. 1996 C. Weber⁸⁸ discussed the razors from southeastern Europe, and calls them the Obkevovice type, thus arguing for the Danubian region as the place where they first appear.

A total of three razors were found as grave goods in this rather small sample of Velika Gorica cemetery, most likely from male graves. In the so-called double burial no. 1/1911, 11 weights in the form of clay rings and a spindle whorl were found, which could lead to the conclusion that a woman, possibly a weaver, was also buried there.

The main difference from the site at Dobova is seen in the appearance of the mentioned "grave of the warrior" no. 1/1911 which contained a sword, a spear, two knives, a razor, four pins, 11 clay rings and a spindle whorl. The antenna terminal sword of the Klentnice type is the most important find of these. This type is found in grave no. 63 at Klentnice⁸⁹. Recently, A. Harding⁹⁰ dated this type of sword to the developed phase of the Ha B period, based on a brief analysis of the items associated with it. In her first synthetic work K. Vinski-Gasparini⁹¹ assigns the sword to the Lipovka type of the flange-hilted swords⁹² and dates it to the Ha B1 period, thus making it one of the oldest finds of the antenna terminal sword.

Besides a razor and a sword, a spear was also found in the grave no. 1/1911. On the lower part of the socket there was an ornament consisting of horizontal and wavy lines. Somewhat similar, both chronologically and in style, is the spear from the fortified settlement⁹³ at Klentnice ascribed to the so called "*zweiflügelige Tüllenspitze mit glattem Blatt und glatter Tülle – Grundform B*" group. Jiří Říhovský⁹⁴ does not make any claims on the dating of this find. It is certain that these spears belong to the younger phase of the Urnfield culture, as the decorative motif is quite similar to the one found on the sword of the Klentnice type. It can be assumed that both the sword and the spear from Velika Gorica were made in the same workshop. A richly decorated metal ending for the wooden spear belongs to the

81. PRIMAS 2007, 303 and Abb. 1.

82. PRIMAS 2007, 303–304 and Abb. 2.

83. PRIMAS 2007, 306–307.

84. STARÉ 1957, 205.

85. STARÉ 1957.

86. STARÉ 1957, 207–209.

87. STARÉ 1957, 213–214.

88. WEBER 1996.

89. ŘIHOVSKÝ 1965, t.18/a, d, f, g.

90. HARDING 1995.

91. VINSKI-GASPARINI 1973.

92. VINSKI-GASPARINI 1973, 156.

93. ŘIHOVSKÝ 1996, t. 20/222.

94. ŘIHOVSKÝ 1996, 91.

same workshop. Velika Gorica spears are similar (both in form and decoration) to the ones found at Napajedl⁹⁵ where the decoration is linked to the motif found on the so-called Pile dwelling type pins that can be dated to the beginning of the younger phase of the Urnfield culture.⁹⁶ This would fit nicely to the overall date for grave no. 1/1911 to the Ha B1 period. Similar spears, although without decoration, are found in the Miljana hoard.⁹⁷ But the most similar type of spear has been found on the territory of Makarska (Adriatic coast) and that is the find from Podace.⁹⁸ The author rightly connected this find with the find from grave 1/1911 at Velika Gorica, the find from the settlement at Donja Dolina and an accidental find from Prozor (Lika).⁹⁹

An antenna terminal knife, decorated with a wave pattern, was also found in grave no. 1/1911. It was part of the warrior equipment buried in the grave and is directly connected, both chronologically and stylistically, with the sword and spear. It has a parallel in a knife from Maribor cemetery.

A flange-hilted knife,¹⁰⁰ similar to those of the Oblekovic type, was also found in the grave,¹⁰¹ although the latter was tang hilted (*Griffangelmesser*). A similar knife was found in the Beravci hoard¹⁰² dated to phase IV of the Urnfield culture of northern Croatia.

In this burial, a socketed axe was also found. It is of the pseudowinged axe type with a wide trapezoid blade form, a type that is also found in the Beravci hoard.¹⁰³ An axe, decorated in a similar manner as the one from Velika Gorica, was discovered in the Vinički II hoard in Slovakia,¹⁰⁴ dated to the Rohod period.

A similar axe was found in grave no. 7/1908, in which a knife with an annular ending and part of a razor were also detected, thus making it likely that the grave was also of a warrior. The knife is of the Seeboden type,¹⁰⁵ dated on the basis of the Seeboden find, which contains the bronze bucket and psalia, to the end of the younger period of the Urnfield culture.¹⁰⁶ This date does not fit to the findings from Velika Gorica that is dated to the Ha B1 period on the basis

of the finds of the pin of the pile dwelling type. At Dobova, this type of knife is found in grave no. 171 that also contains an urn with a hole in the middle.¹⁰⁷

The inventory of grave no. 1/1910, most likely of a male warrior, consists of a single spear heavily damaged by fire, a whetstone, two pins (one of the pile dwelling type) and a fragment of a spectacle fibula. The male burial from grave no. 2/1910 with a razor of Oblekovic type and fragments of three knives is similar to this grave. The knives are quite fragmented but one of them can be recognized as a flange-hilted knife, with parallels in the knife from grave no. 1/1911 (T. 12, 2), for which we have argued similarities to the knives from the Beravci hoard. An additional two such knives were found outside closed grave contexts, making a clear connection between finds from graves and hoards. It could also be an additional argument in favour of production of flange-hilted knives in local workshops.

The male grave no. 4/1911 (fig. 9) is of particular interest. It contained a bronze knife, part of a hair decoration, and a fibula. The knife was maybe similar to the Hadersdorf type,¹⁰⁸ decorated with a wave-like motif, dated to the beginning of the Podoli phase, based on the finds from Klentnice.¹⁰⁹

9. Conclusion

The significance of the Velika Gorica cemetery lies in the find of a warrior's grave (fig. 11), which also makes it unique compared to the graves found at Dobova, Ruše, and Ljubljana, where such graves were not discovered.¹¹⁰

Finds such as jewellery and toiletries, are the most abundant. B. Teržan¹¹¹ recognizes this change and states that instead of rich hoards, urn grave sites such as Ruše and Ljubljana appear in Slovenia. She connects this change to an alteration in religious views, which means that in the time of the transition from Ha A to Ha B (according to Hermann Müller-Karpe) important changes in cult and religion of the Urnfield culture can be observed in Slovenia. A similar situation is seen in continental Croatia where, during the Ha B period, a small number of hoards appear, but also those of the so-called Balkan-type are found (e.g. Gajina pećina and Matijeivići). The situation is the reverse in the Balkan region, where a great number of hoards appear. It is clear that the workshops are moving southwards of the Sava and

95. ŘÍHOVSKÝ 1996, t. 8/64.

96. ŘÍHOVSKÝ 1996, 54.

97. VINSKI-GASPARINI 1973, t. 112/3, 4.

98. TOMASOVIĆ 2003, fig. 1.

99. TOMASOVIĆ 2003, 167, fig. 2.

100. KARAVANIĆ 2009, pl. 61/2, 2a.

101. ŘÍHOVSKÝ 1972, t. 20/227; t. 21/228–230.

102. VINSKI-GASPARINI 1973, t. 108/22–23, 25.

103. VINSKI-GASPARINI 1973, t. 108/10–12.

104. NOVOTNÁ 1970, 91.

105. ŘÍHOVSKÝ 1972, 44 and t. 14/144–146.

106. MÜLLER-KARPE 1959, 130, 169.

107. STARÉ 1975, t. 24/13.

108. ŘÍHOVSKÝ 1972, t. 22.

109. ŘÍHOVSKÝ 1972, t. 21/238.

110. TERŽAN 1995, fig. 12–15.

111. TERŽAN 1995, 337.

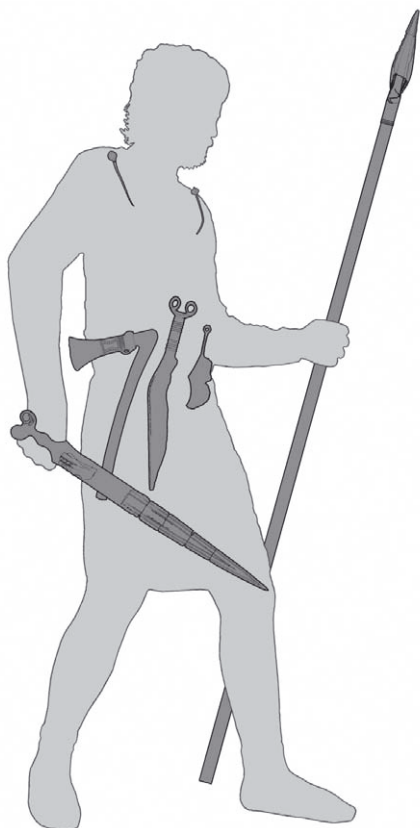

Fig. 11. The reconstruction of warrior grave 1/1911 at Velika Gorica (by Miljenko Gregl).

Kupa rivers. K. Kristiansen¹¹² sees the appearance of prestigious items in graves as the formation of new elites whose members are to be buried in larger burial mounds. The grave of the warrior 1/1911 from Velika Gorica and grave no. 63 from Klentnice are the forerunners of the new socio-economic relationships that are going to reach their peak during the Ha C period.

Bibliography

BALEN-LETUNIĆ 1981

D. BALEN-LETUNIĆ, Grobovi kasnog brončanog i starijeg željeznog doba iz okolice Karlovca, *VjesAMuzZagreb* XIV, 1981, 11–23.

BRUNŠMID 1898

J. BRUNŠMID, Groblje sa urnama u Krupačama kod Krašića u Hrvatskoj, *Vjesnik Hrvatskog Arheološkog društva n.s.* III, 1898, 137–143.

ČREŠNAR 2006

M. ČREŠNAR, Novi žarni grobovi iz Ruš in pogrebni običaji v ruški žarnogrobišni skupini, *AVes* 57, 2006, 97–162.

DULAR 1978

J. DULAR, Poskus kronološke razdelitve dobovskega žarnega grobišča, *AVes* 29, 1978, 36–46.

HOFFILLER 1909

V. HOFFILLER, Staro groblje u Velikoj Gorici, *Vjesnik Hrvatskog Arheološkog društva n.s.* X, 1909, 120–134.

HOFFILLER 1924

V. HOFFILLER, Prehistorijske žare iz Velike Gorice kraj Zagreba. In: M. ABRAMIĆ, V. HOFFILLER (eds.), *Bulićev zbornik. Naučni prilozi posvećeni Franu Buliću prigodom LXXV. Godišnjice njegova života od učenika i prijatelja*, Zagreb/Split 1924, 1–8.

HOFFILLER 1938

V. HOFFILLER, Groupe Vic (Vallée de Danube). In: *Zagreb Musée National 2, CVA Yougoslavie 2*, Belgrade 1938.

KARAVANIĆ 2000

S. KARAVANIĆ, Prijelaz iz starije u mlađu kulturu polja sa žarama u sjevernoj Hrvatskoj, PhD Thesis, Department of archaeology, Faculty of Art and Humanities, Zagreb 2000.

KARAVANIĆ 2009

S. KARAVANIĆ, The Urnfield Culture in Continental Croatia, *BARIntSer* 2036, 2009.

KRISTIANSEN 1998

K. KRISTIANSEN, *Europe Before History*, Cambridge 1998.

LJUBIĆ 1885

Š. LJUBIĆ, Prvo otkriće predhistoričkih grobja od žara u Hrvatskoj, *Vjesnik Hrvatskog Arheološkog Društva* VII/3, 1885, 5–72.

LOŽNJAK 2003

D. LOŽNJAK, Grobovi virovitičke grupe iz Voćina, *Prilozi-Zagreb* 20, 2003, 33–45.

MAJNARIĆ-PANDŽIĆ 1988

N. MAJNARIĆ-PANDŽIĆ, Prilog poznavanju kasnoga brončanog doba u sjeverozapadnoj Hrvatskoj, *ARadRaspr* 11, 1988, 9–27.

MAJNARIĆ-PANDŽIĆ 1992

N. MAJNARIĆ-PANDŽIĆ, Ljevaonica brončanih predmeta u kasnobrončanodobnom naselju na Kalniku kod Križevaca, *Opuscula Archaeologica* 16, 1992, 57–73.

MAJNARIĆ-PANDŽIĆ 1994

N. MAJNARIĆ-PANDŽIĆ, Novi kasnobrončanodobni grobovi iz Drljanovca kod Nove Rače, *BjelovarZbor* 4–5, 1994, 43–56.

MARIJAN 2005

B. MARIJAN, Zaštitno arheološko istraživanje nalazišta Popernjak kod Bošnjaka (Županja), *Obavijesti HAD-a*, 37/2, 2005, 35–41.

¹¹² KRISTIANSEN 1998, 75.

- MEDOVIĆ 1988
P. MEDOVIĆ, Kalakača. Naselje ranog gvozdenog doba, Novi Sad 1988.
- METZNER-NEBELSICK 2002
C. METZNER-NEBELSICK, Der „Thrako-Kimmerische“ Formenkreis aus der Sicht der Urnenfelder- und Hallstattzeit im südöstlichen Pannonien, Vorgeschichtliche Forschungen 23, Rahden/Westf. 2002.
- MIHALJEVIĆ, KALAFATIĆ 2004
M. MIHALJEVIĆ, H. KALAFATIĆ, Istraživanje brončanodobnog naselja Mačkovac-Crišnjevi u godini 2003, Obavijesti HAD-a 36/1, 2004, 40–44.
- MINICHREITER 1983
K. MINICHREITER, Pregled istraživanja nekropola grupe „Gredani“ u Slavoniji, Anali Zavoda za znanstveni i umjetnički rad u Osijeku 2, 1982–1983, 7–122.
- MÜLLER-KARPE 1959
H. MÜLLER-KARPE, Beiträge zur Chronologie der Urnenfelderzeit nördlich und südlich der Alpen, RGF 22, 1959.
- NOVOTNÁ 1970
M. NOVOTNÁ, Die Äxte und Beile in der Slowakei, PBF IX/3, 1970.
- PAHIČ 1972
S. PAHIČ, Pobrežje, Katalogi in monografije 6, Ljubljana 1972.
- PRIMAS 2007
M. PRIMAS, Spinnwirtel im Grab – zum Symbolgehalt einer Beigabe, In: M. BLEČIĆ, M. ČREŠNAR, B. HÄNSEL, A. HELLMUTH, E. KAISER, C. METZNER-NEBELSICK (eds.), Scripta praehistorica in honorem Biba Teržan, Situla 44, 2007, 301–312.
- ŘÍHOVSKÝ 1965
J. ŘÍHOVSKÝ, Das Urnengräberfeld von Klentnice, FontA Prag 8, 1965.
- ŘÍHOVSKÝ 1972
J. ŘÍHOVSKÝ, Die Messer in Mähren und dem Ostalpengebiet, PBF VII/1, 1972.
- ŘÍHOVSKÝ 1996
J. ŘÍHOVSKÝ, Die Lanzen-, Speer- und Pfeilspitzen in Mähren, PBF V/2, 1996.
- SOKOL 1990
V. SOKOL, Grob br. 7 kulture žarnih polja iz Moravča kod Seseveta (Zagreb), AVes 39–40, 1989–1990, 425–432.
- SOKOL 1996
V. SOKOL, Nekropola kulture žarnih polja u Moravču kod Seseveta, HAD 17, 1996, 29–57.
- STARÉ 1953
F. STARÉ, Ilirsko grobišče pri Dobovi. Iskopavanja leta 1952, Razprave 3, Slovenska akademija znanosti in umetnosti, Ljubljana 1953, 264–272.
- STARÉ 1957a
F. STARÉ, Tombes plates à urne à Dobova en Slovénie et à Velika Gorica en Croatie. Inventaria Archaeologica, Corpus des ensembles archéologiques, Jugoslavija, fascicule I: Y1–Y10, Bonn 1957.
- STARÉ 1957b
F. STARÉ, Polmesečne britve iz Jugoslavije, AVes 3–4, 1957, 204–222.
- STARÉ 1960
F. STARÉ, Grob 108 iz Dobove, Situla 1, 1960, 81–101.
- STARÉ 1975
F. STARÉ, Dobova, Brežice 1975.
- SVOLJŠAK, POGAČNIK 2001
D. SVOLJŠAK, A. POGAČNIK, Tolmin, prazgodovinsko grobišče I, Katalogi in monografije 34, Ljubljana 2001.
- SVOLJŠAK, POGAČNIK 2002
D. SVOLJŠAK, A. POGAČNIK, Tolmin, prazgodovinsko grobišče II, Katalogi in monografije 35, Ljubljana 2002.
- TERŽAN 1995
B. TERŽAN, Stand und Aufgaben der Forschungen zur Urnenfelderzeit in Jugoslawien. In: M. ZU ERBACH (ed.), Beiträge zur Urnenfelderzeit nördlich und südlich der Alpen, MonoRGZM 35, Mainz 1995, 323–372.
- TERŽAN 1999
B. TERŽAN, An Outline of the Urnfield Culture Period in Slovenia, AVes 50, 1999, 97–143.
- TOMASOVIĆ 2003
M. TOMASOVIĆ, Kasnobrončanodobno koplje iz Podace u gornjem Makarskom primorju, OA 27, 2003, 165–170.
- VINSKI-GASPARINI 1973
K. VINSKI-GASPARINI, Kultura polja sa žarama u sjevernoj Hrvatskoj, Zadar 1973.
- VRDOLJAK 1996
S. VRDOLJAK, Prapovijesno naselje na Kosovcu kod Bregane (Samobor), Opuscula Archaeologica 20, 1996, 179–184.
- WEBER 1996
C. WEBER, Die Rasiermesser in Südosteuropa, PBF VIII/5, 1996.

Dr. Snježana Karavanić
Institute of Archaeology
Ulica Ljubnerita Gaja 32
HR-10000 Zagreb
snjezana.karavanic@iarh.hr

