

GRAB 493

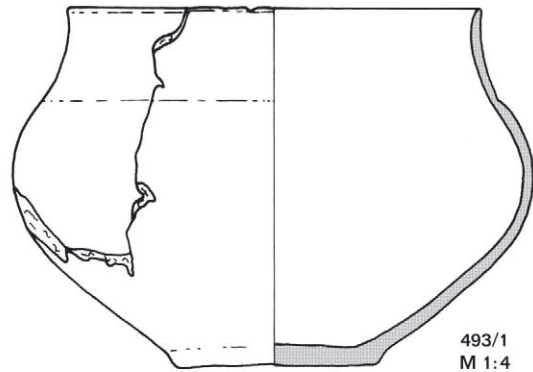

493/1
M 1:4

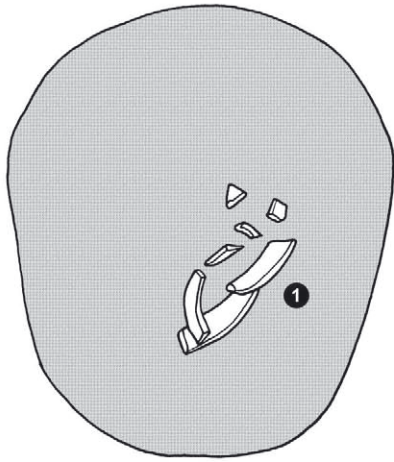
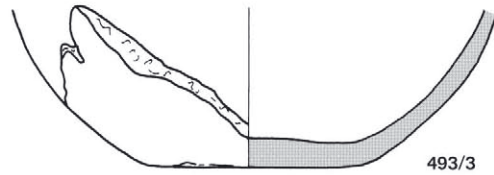

493/3

GRAB 494

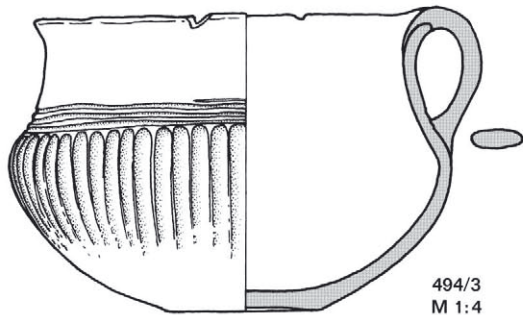
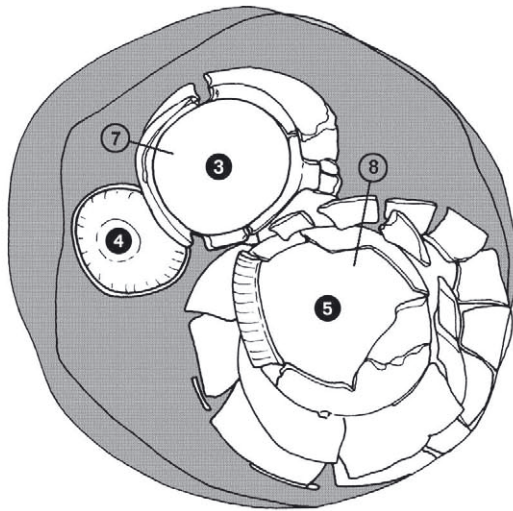

494/3
M 1:4

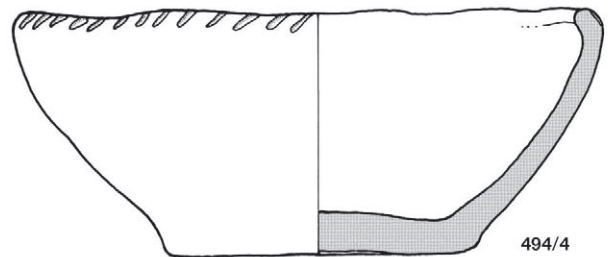

494/4



GRAB 494

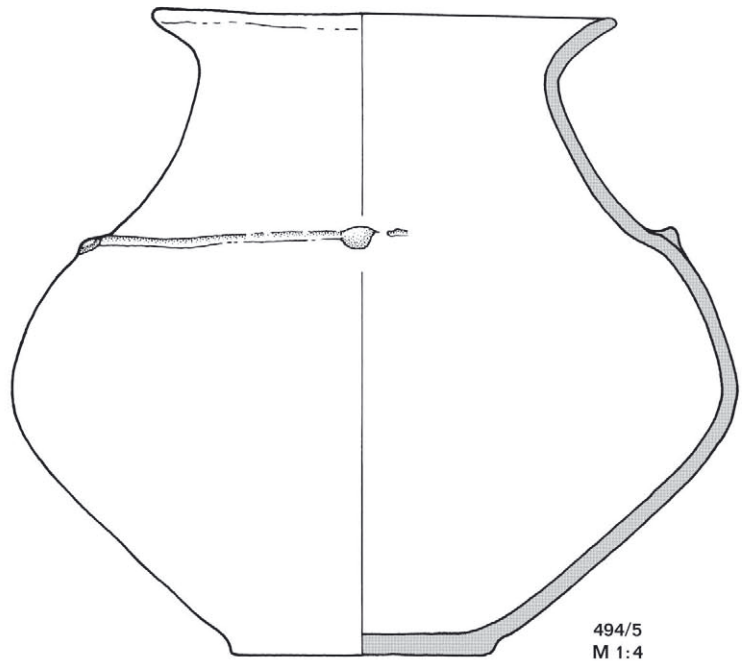
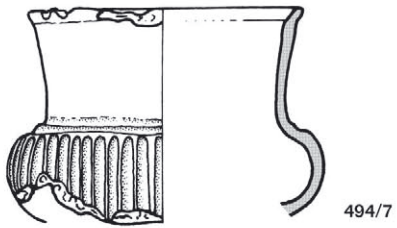

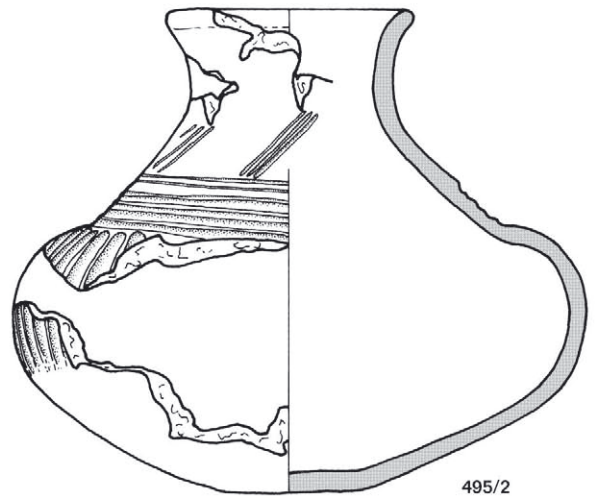
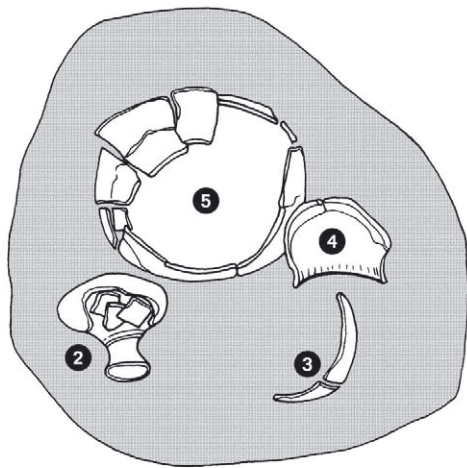

495/2

GRAB 495

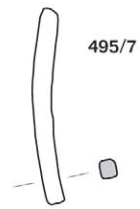

495/7

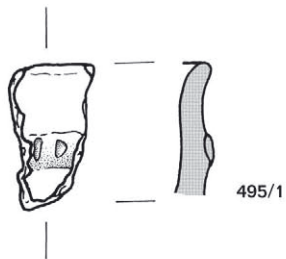

495/1

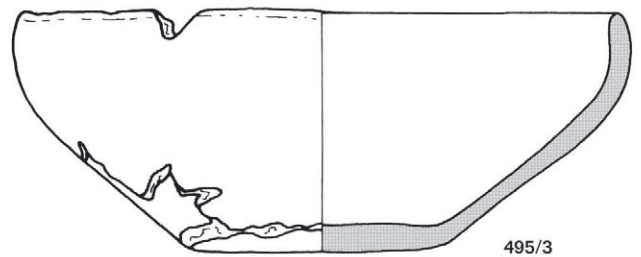

495/3

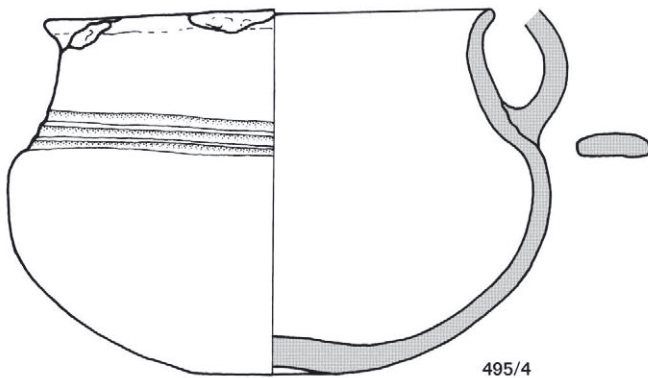

495/4

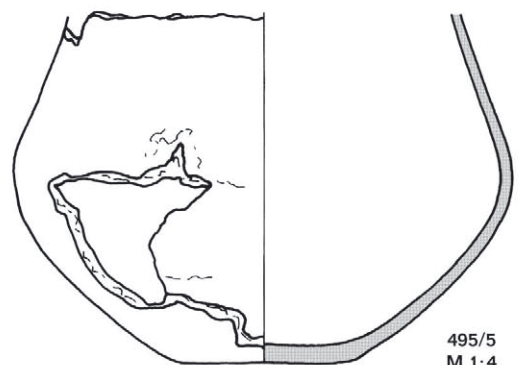

495/5
M 1:4

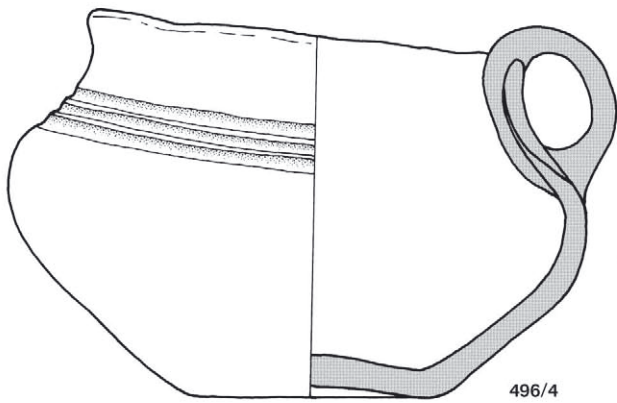

496/4

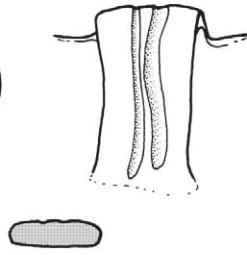

GRAB 496

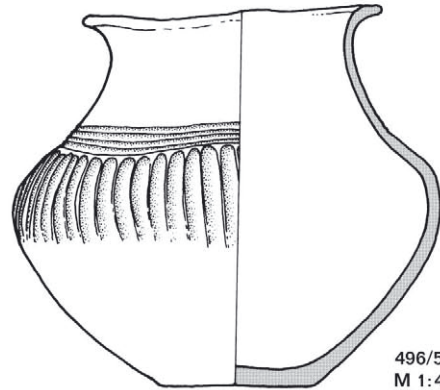

496/5
M 1:4

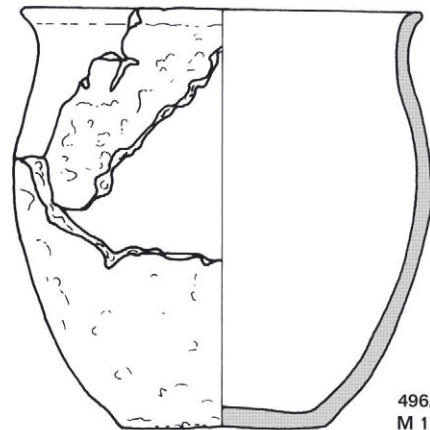
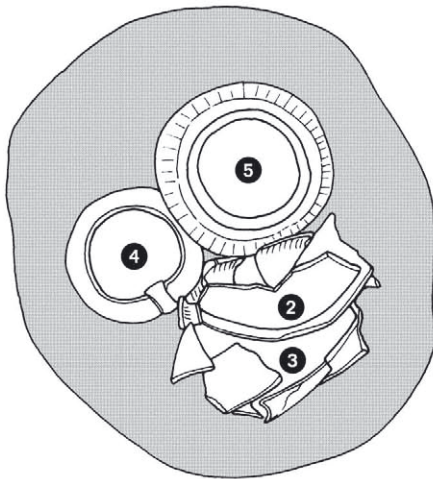

496/2
M 1:4

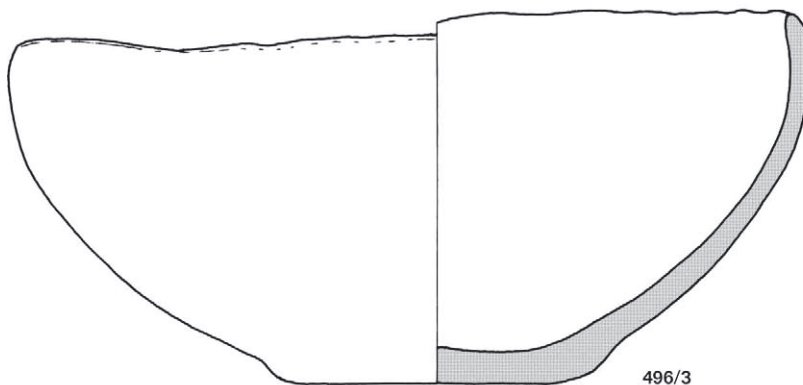

496/3

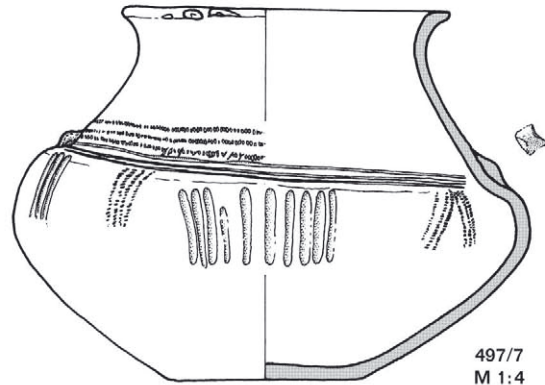
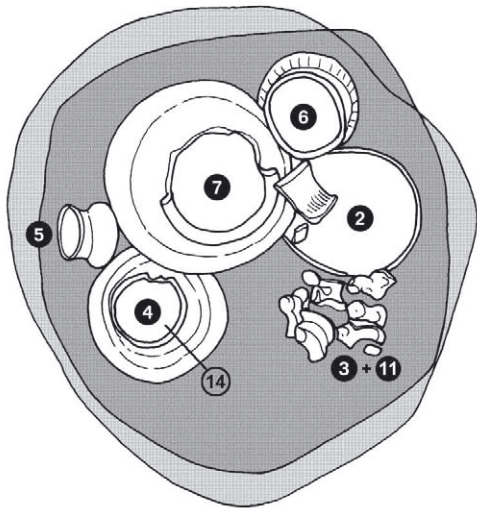

497/7
M 1:4

GRAB 497

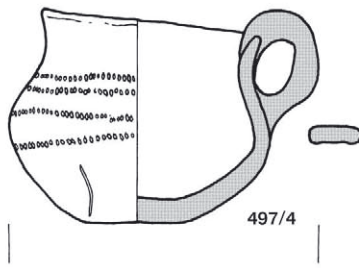

497/4

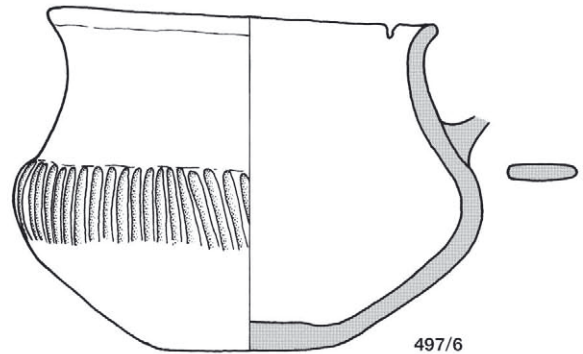

497/6

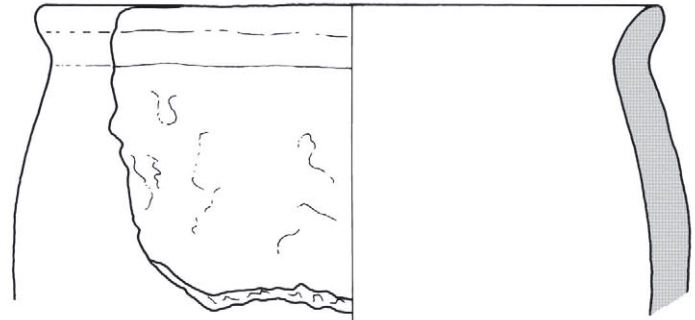
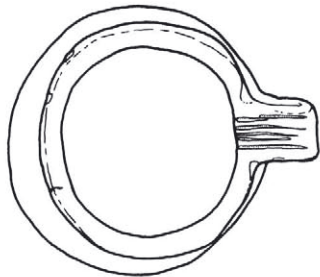

497/1

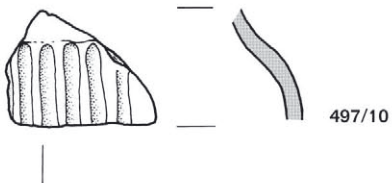

497/10

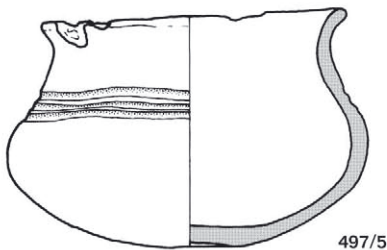

497/5

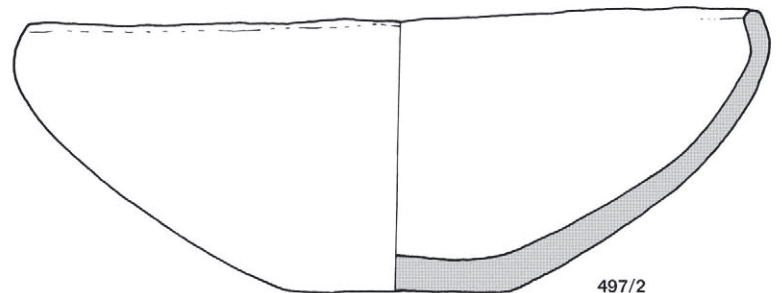

497/2

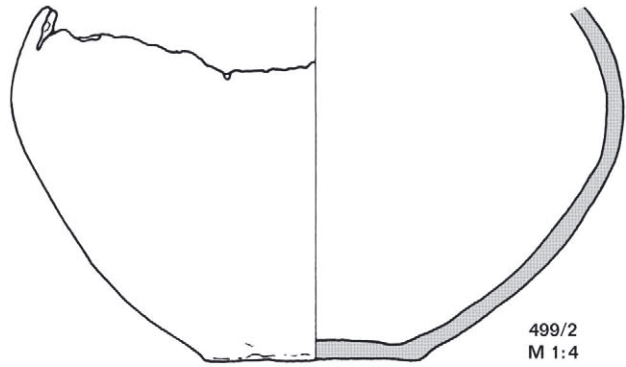
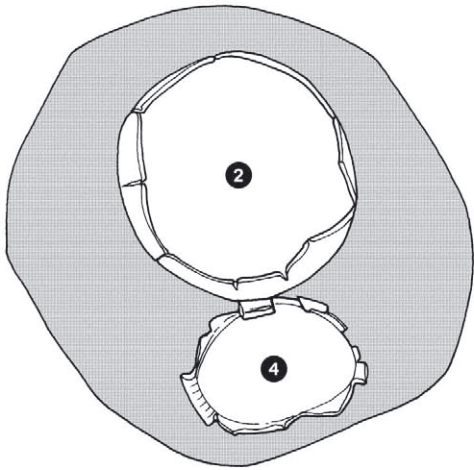

499/2
M 1:4

GRAB 499

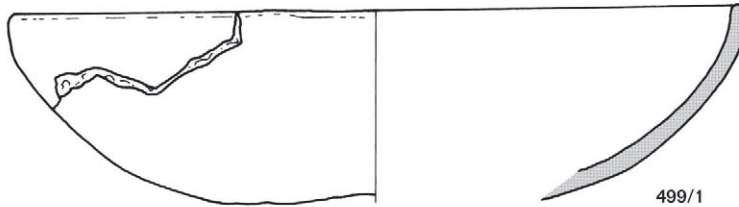

499/1

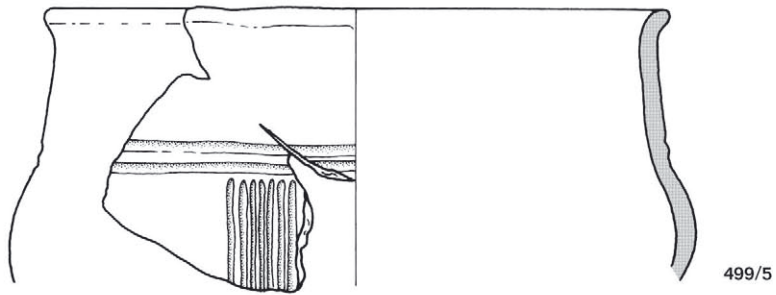

499/5

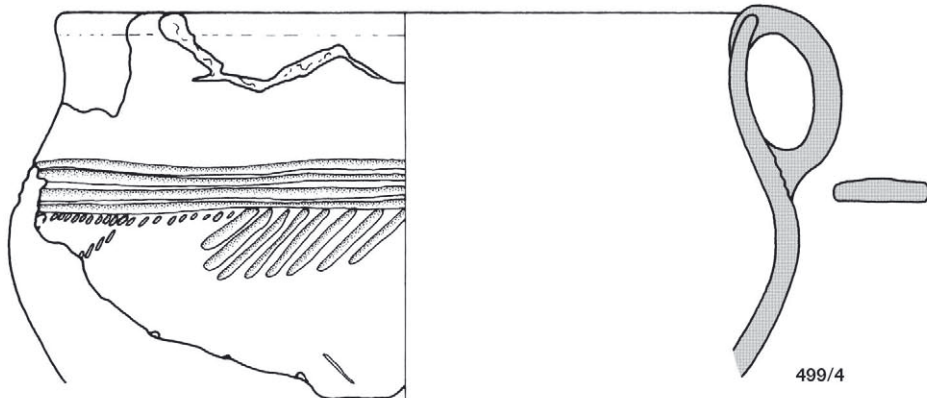

499/4

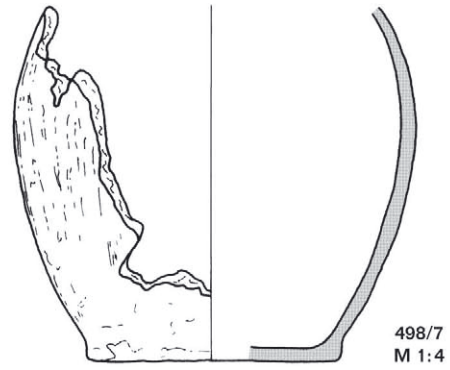
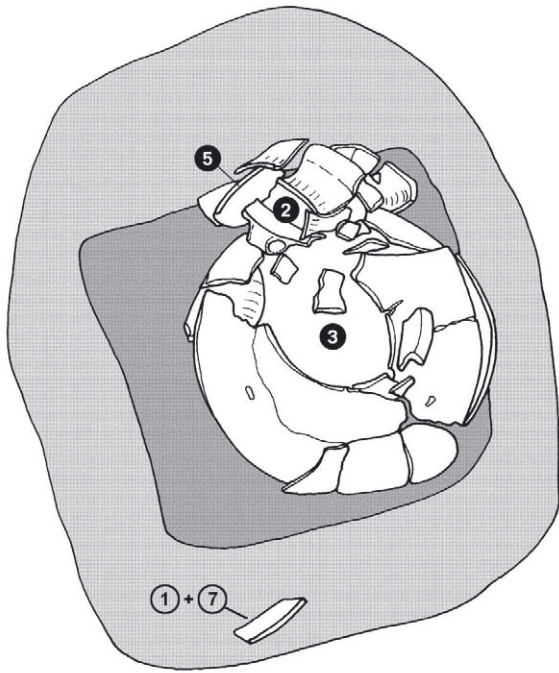

GRAB 498

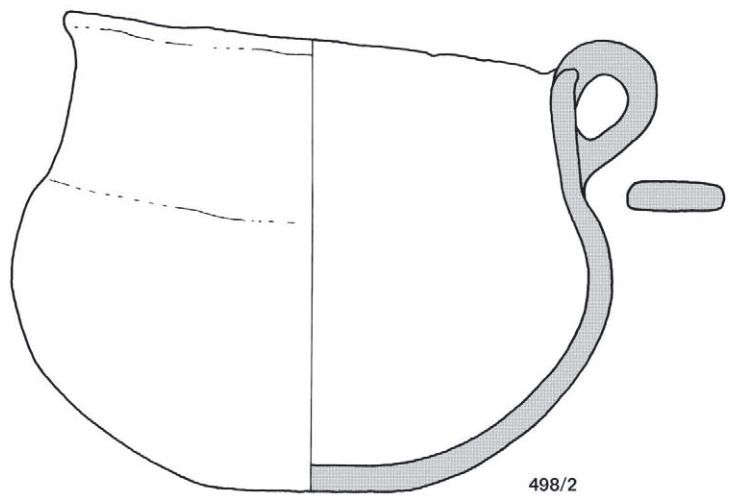
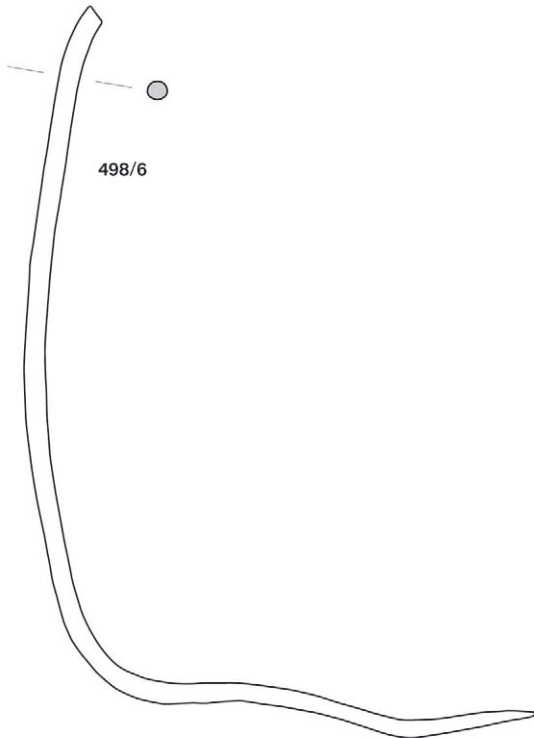
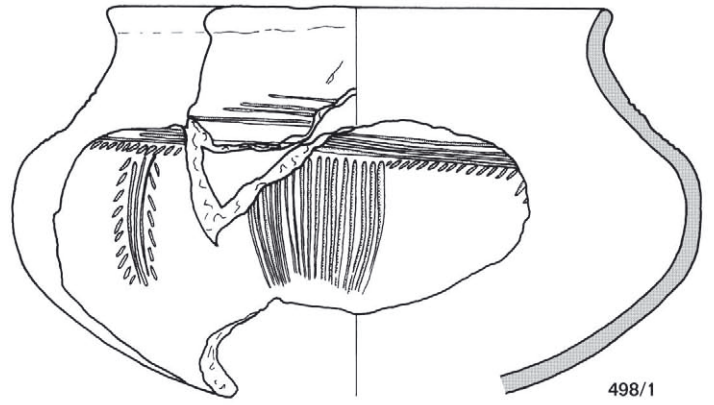

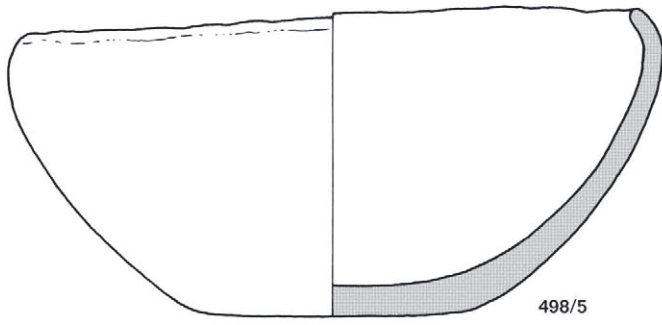

498/5

GRAB 498

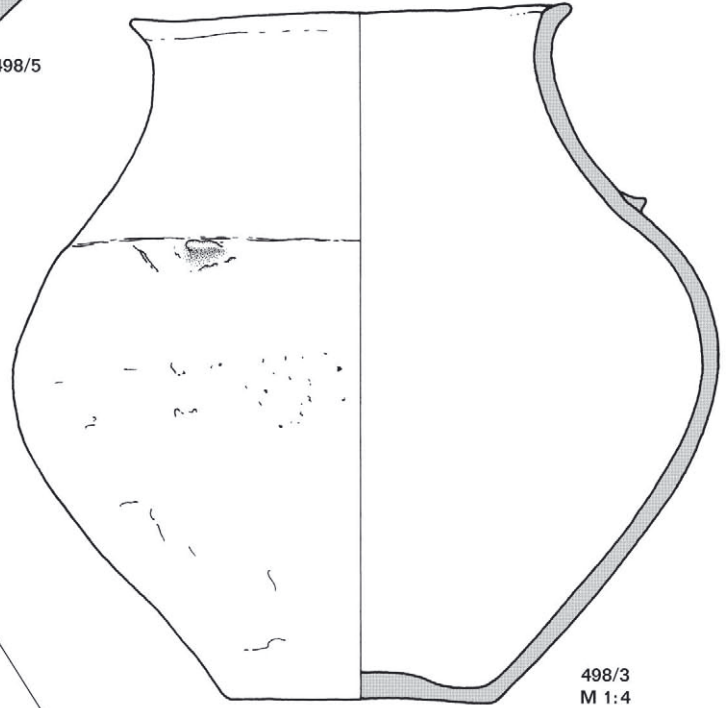

498/3
M 1:4

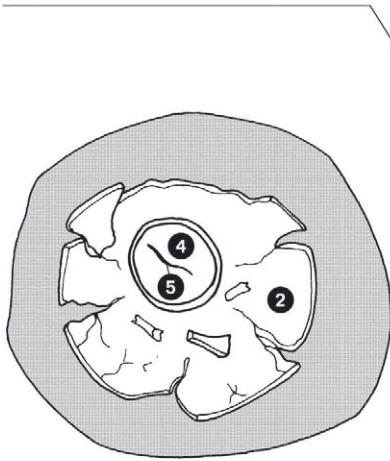

GRAB 502



502/5

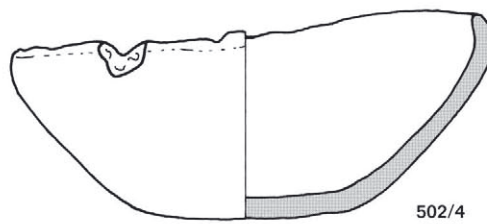

502/4

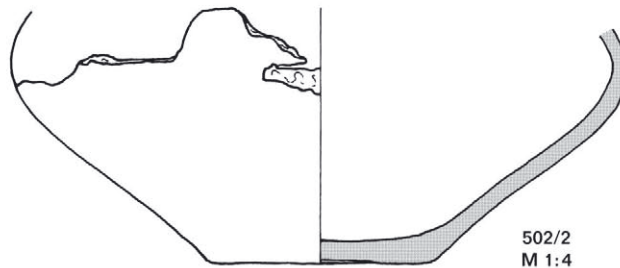

502/2
M 1:4

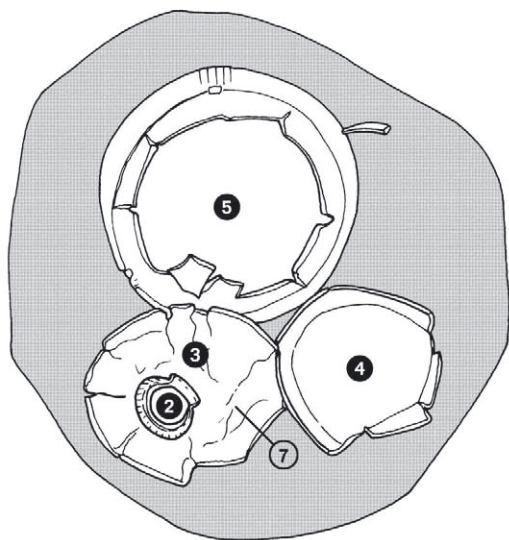

GRAB 501

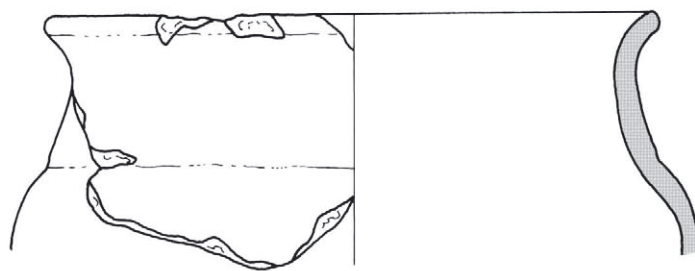

501/7

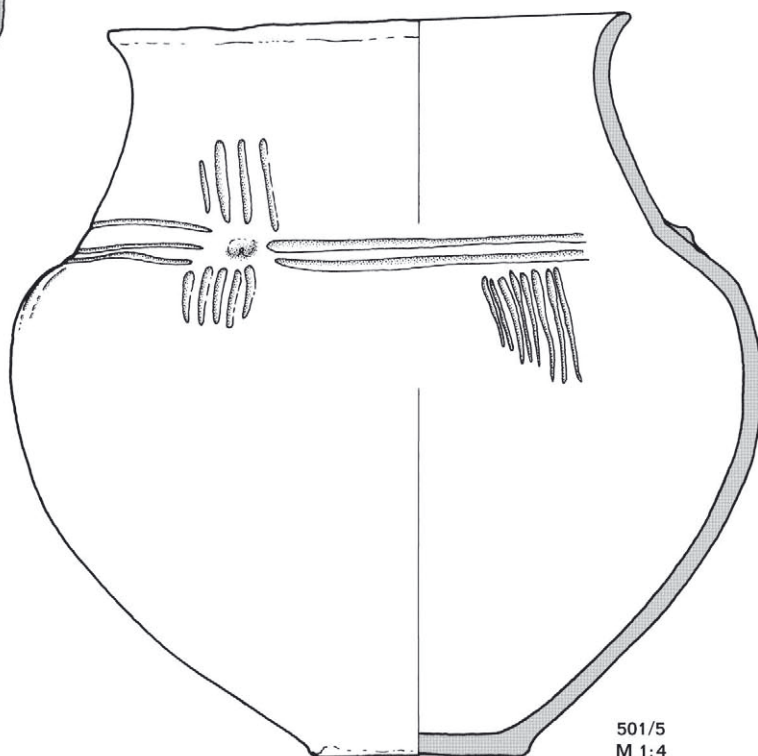

501/5
M 1:4

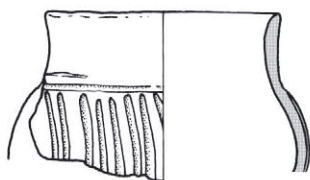

501/2

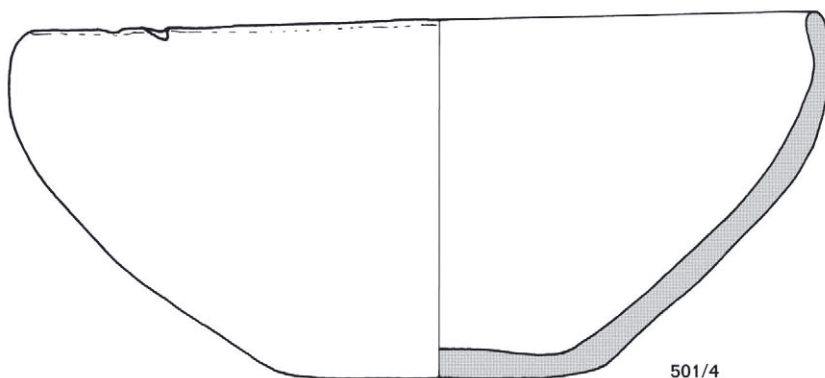

501/4

GRAB 501

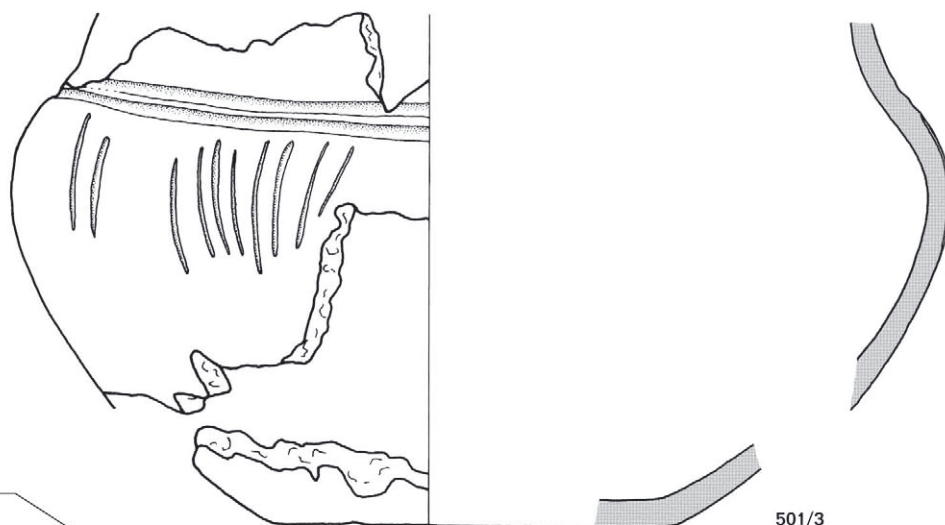

501/3

GRAB 504

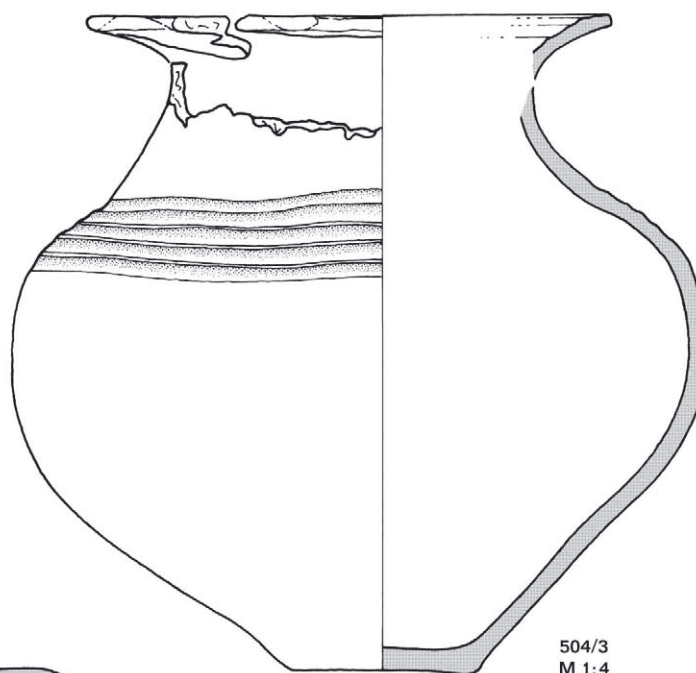
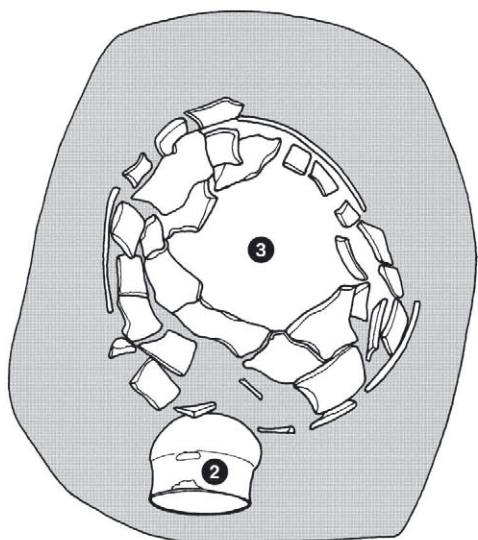

504/3
M 1:4

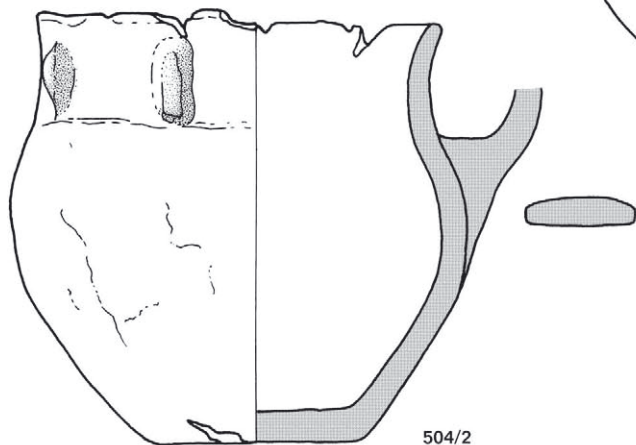

504/2

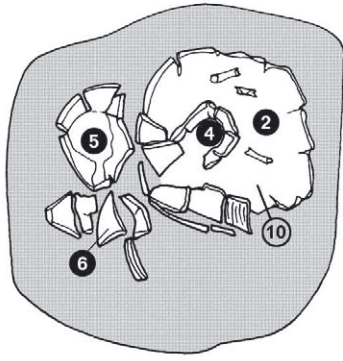

GRAB 503

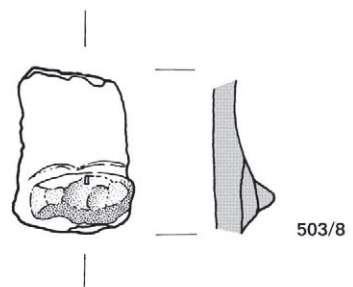
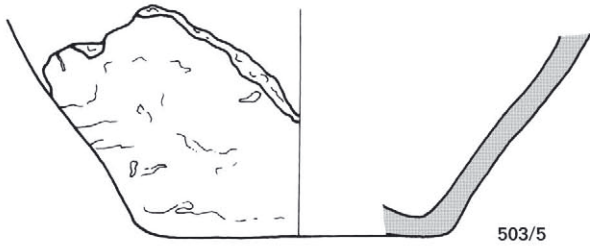
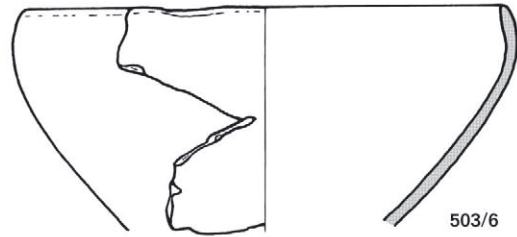
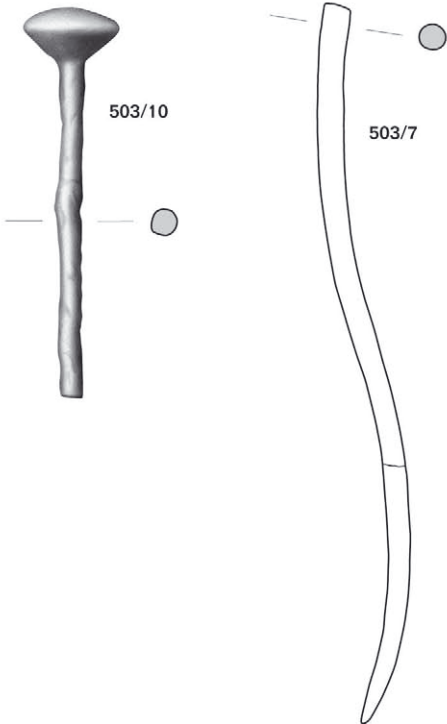
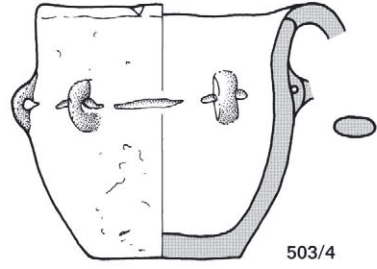

GRAB 503

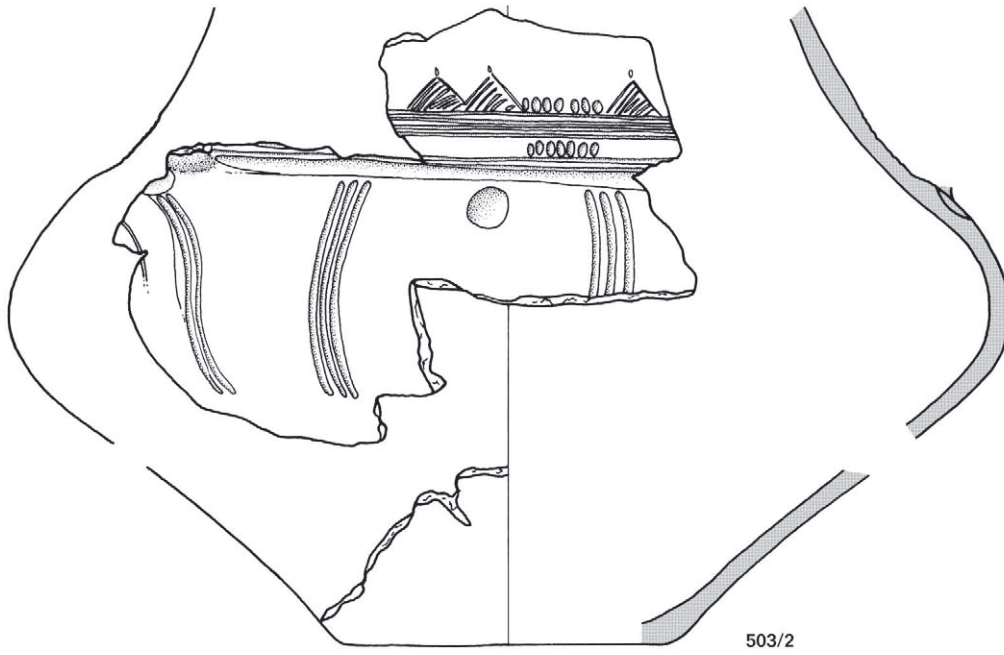

503/2

GRAB 505

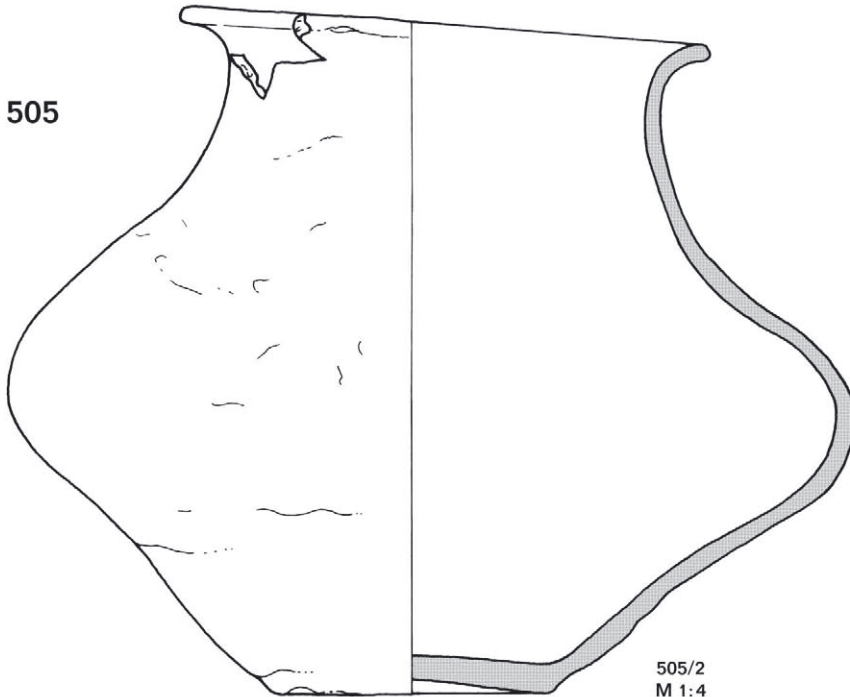

505/2
M 1:4

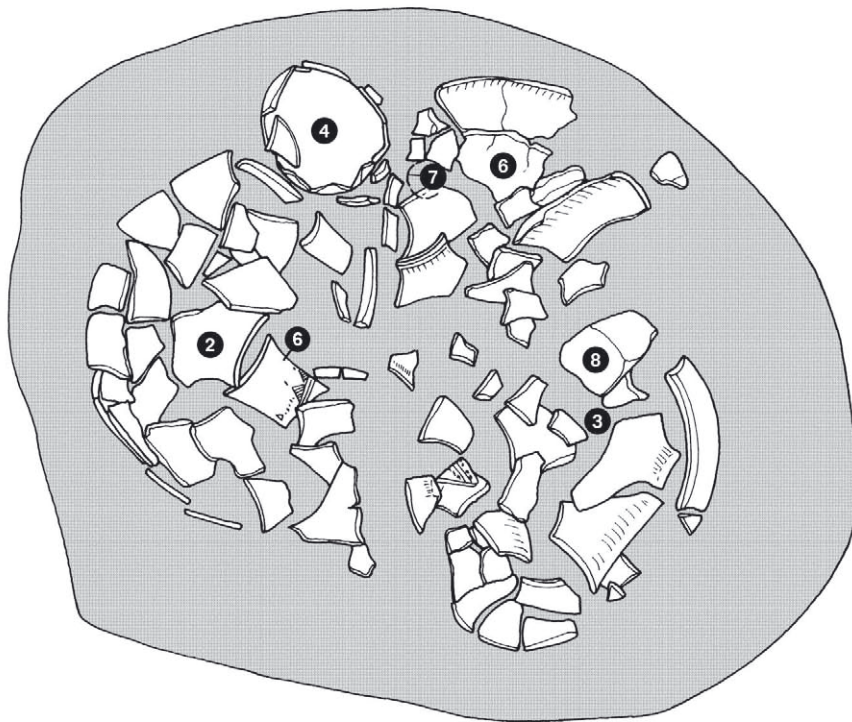

GRAB 505

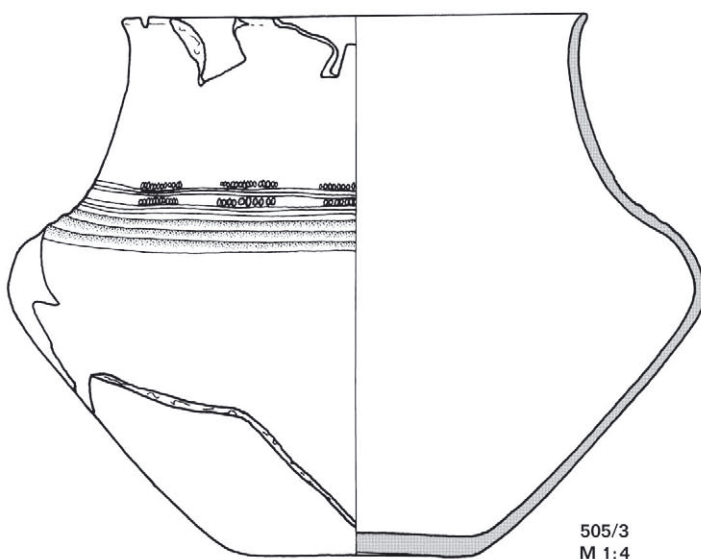
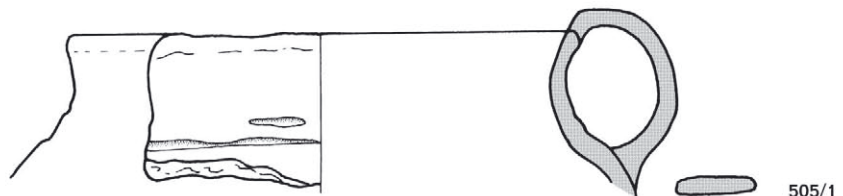

505/3
M 1:4

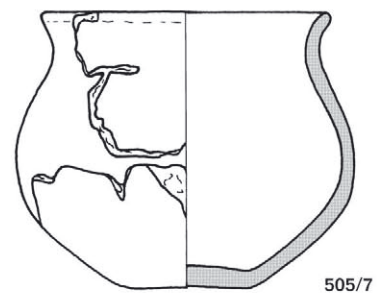

505/7

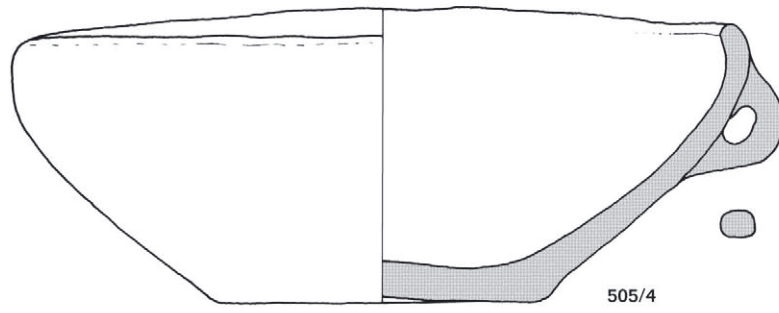

GRAB 505

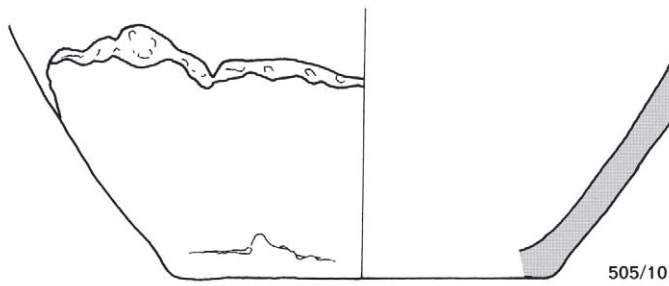
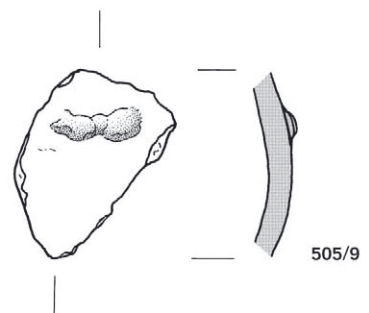
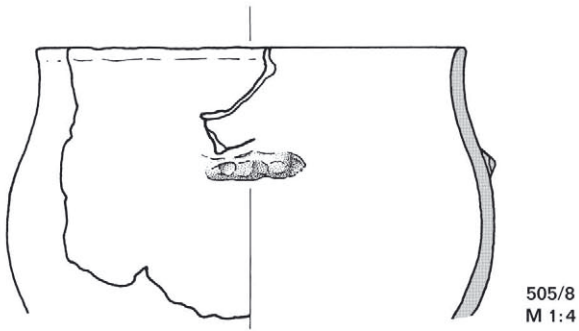
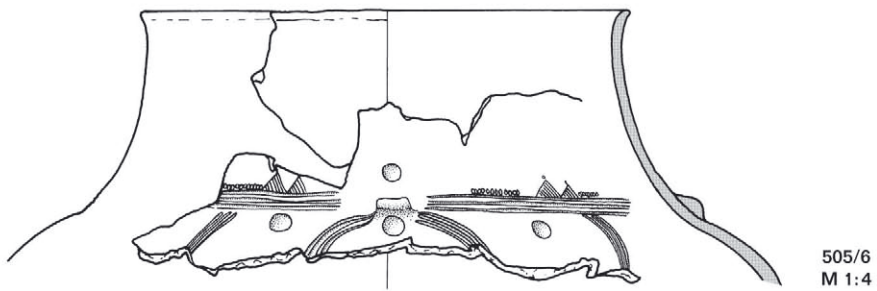

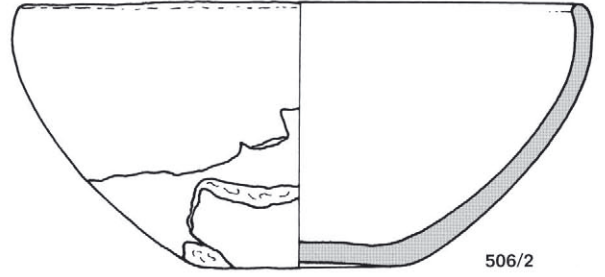
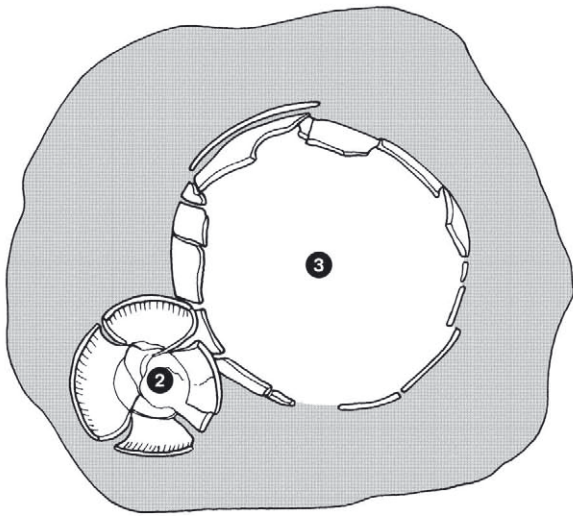

GRAB 506

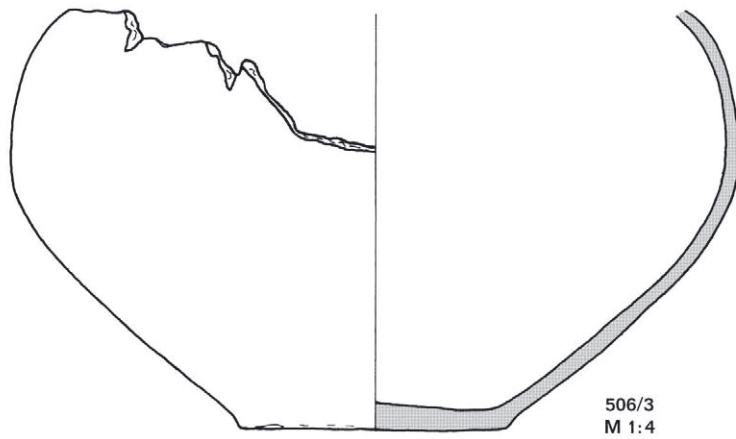
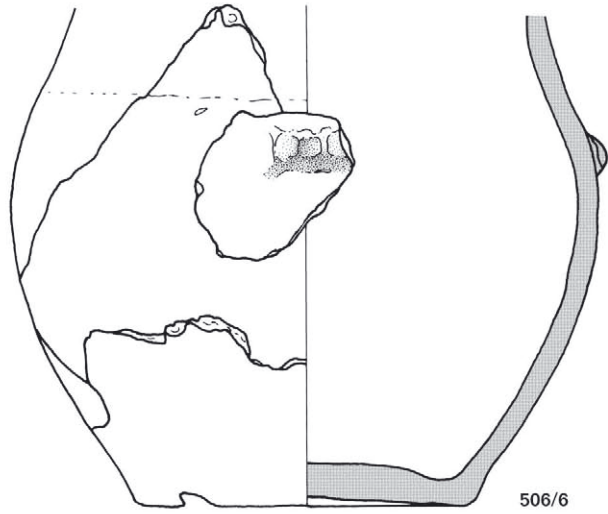
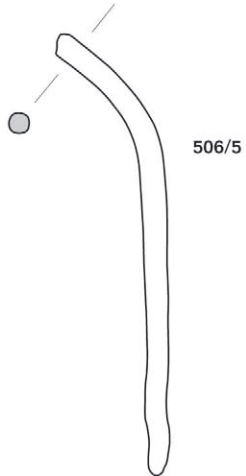

GRAB 507

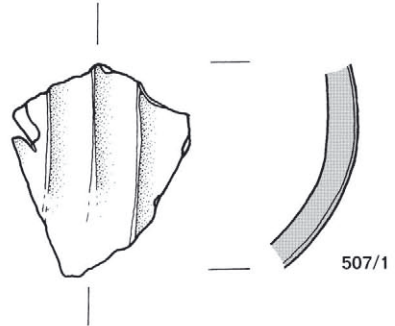
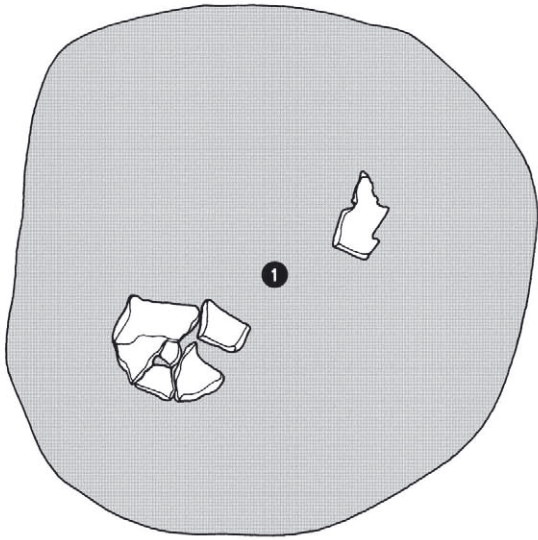

GRAB 508

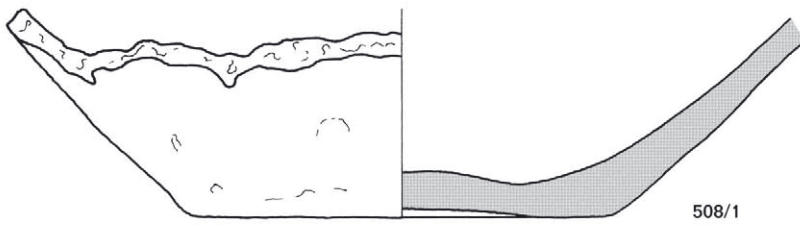
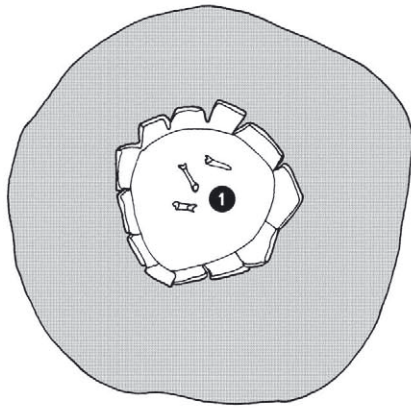

GRAB 509

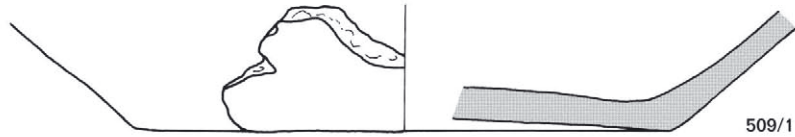
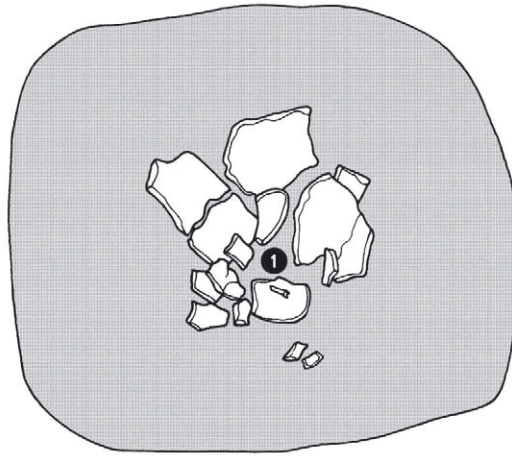

GRAB 510

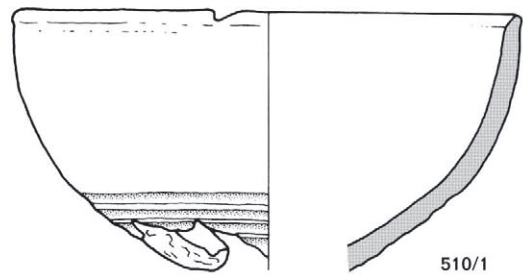
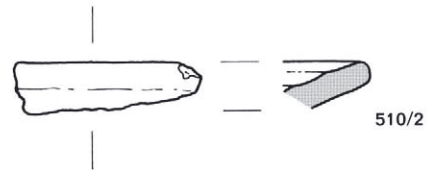
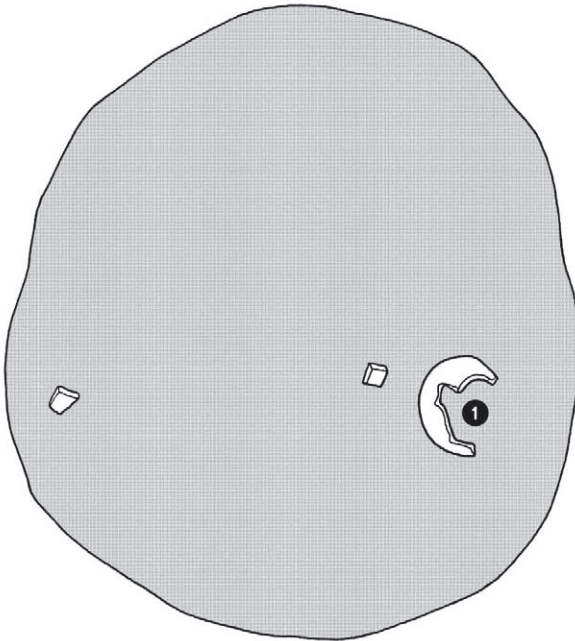

GRAB 511

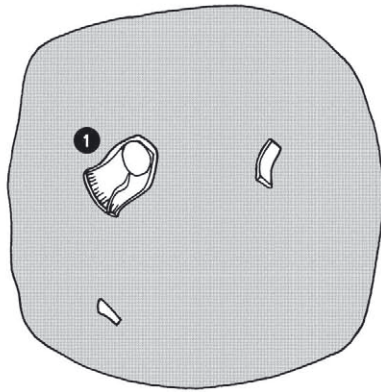

511/2

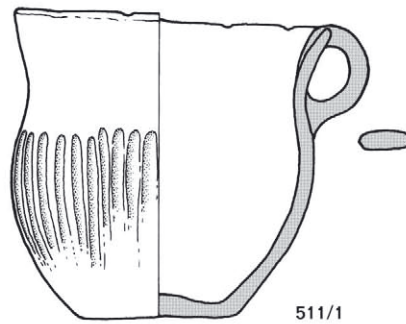

511/1

GRAB 512

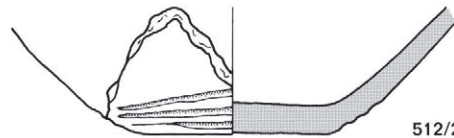
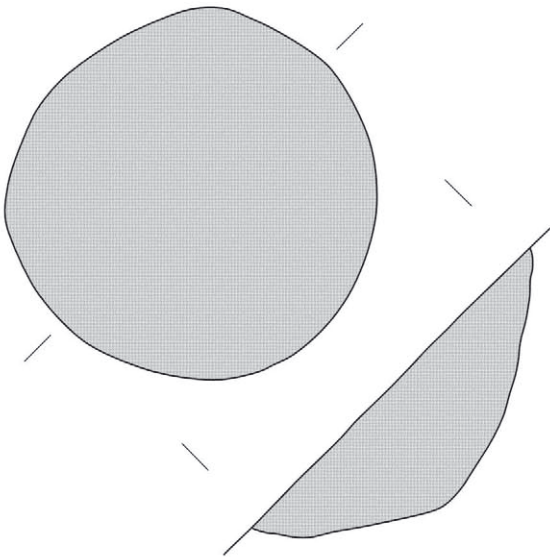

512/2

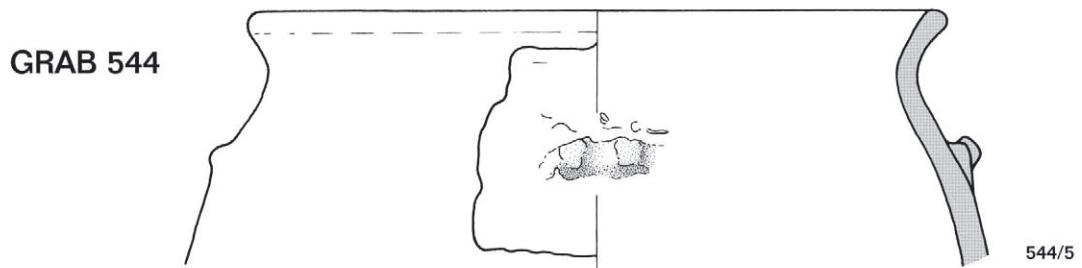
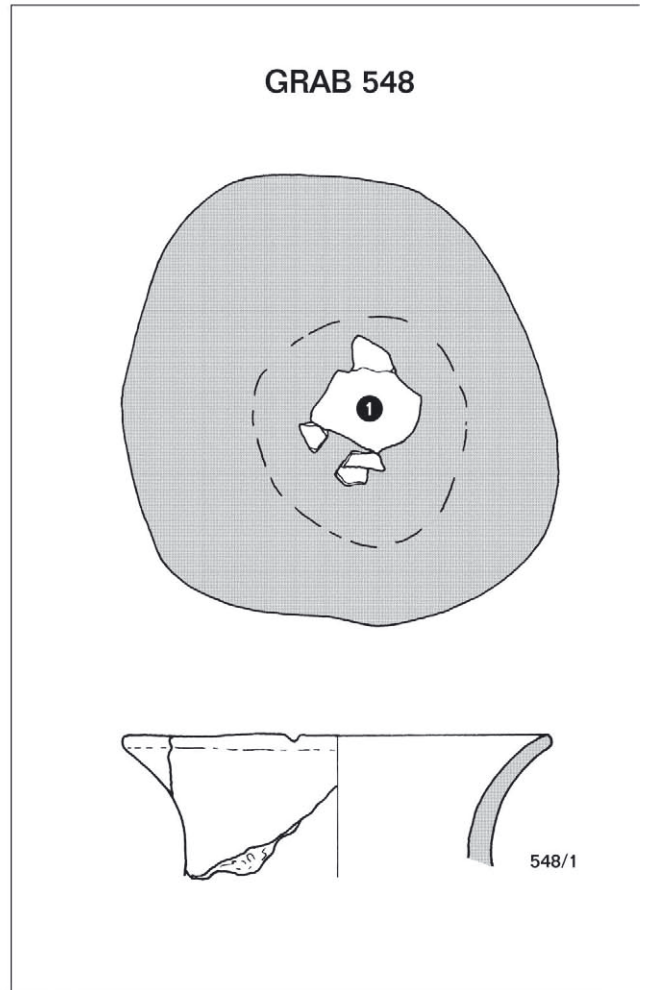
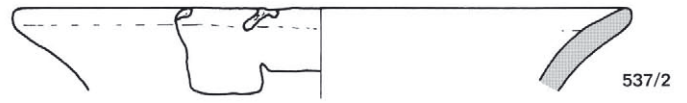
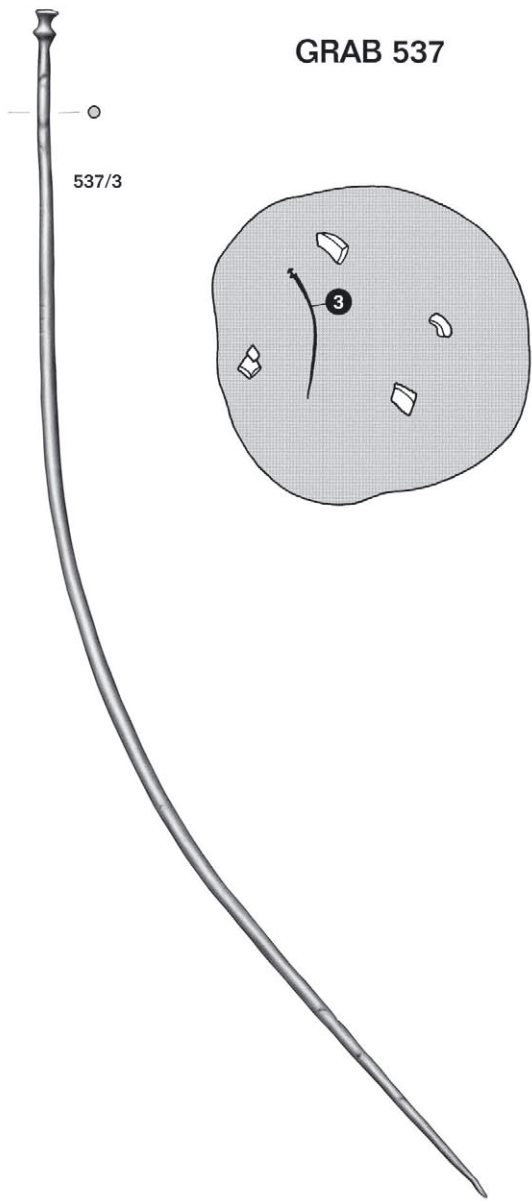

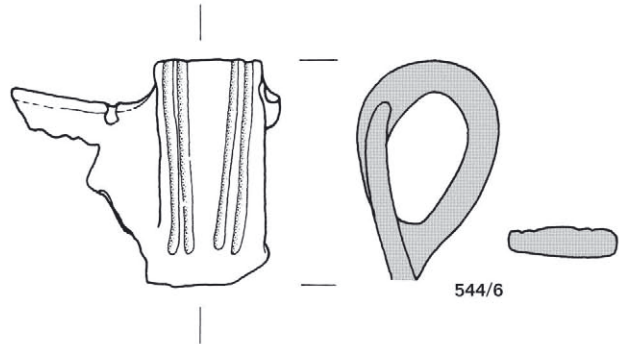
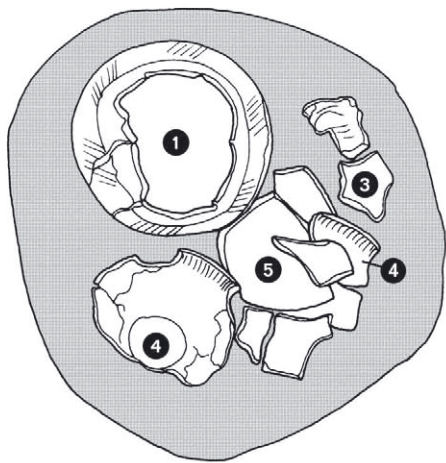

GRAB 544

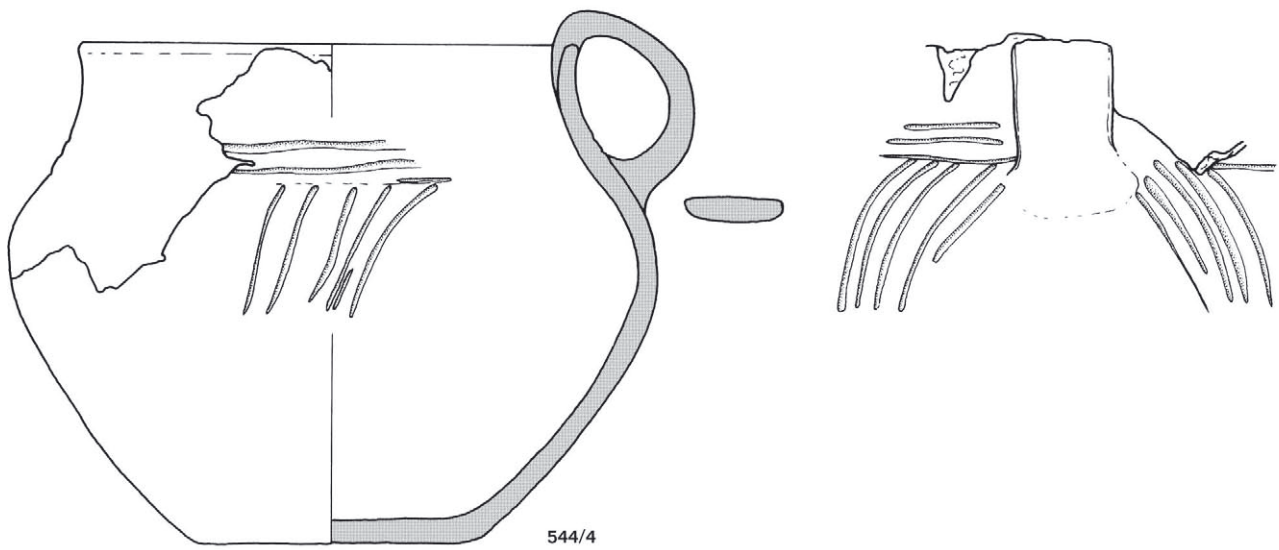
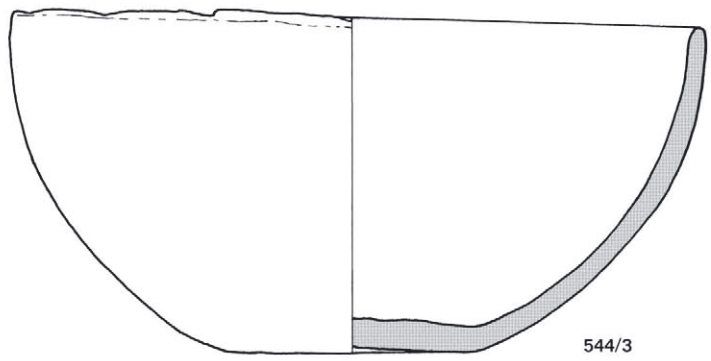
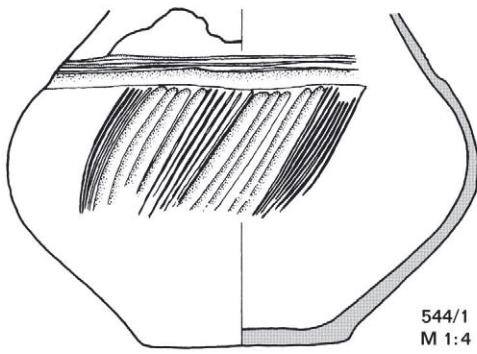

GRAB 545

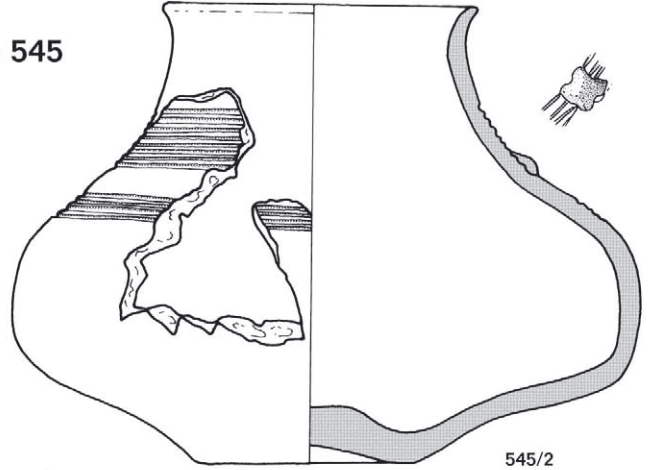
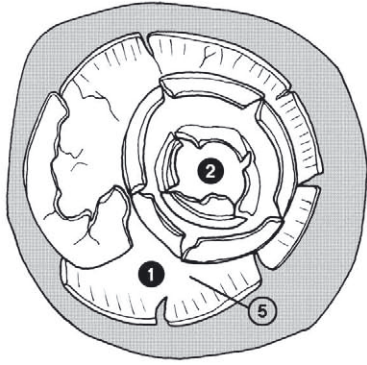

545/2

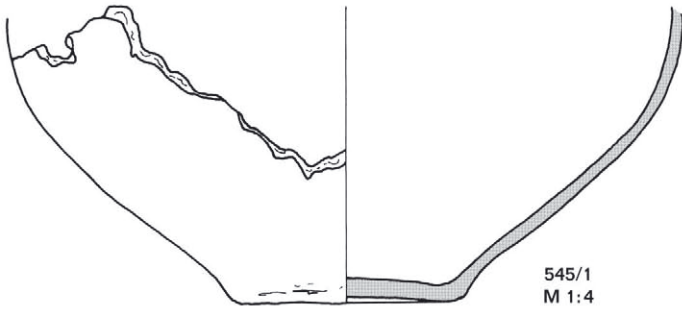

545/1
M 1:4

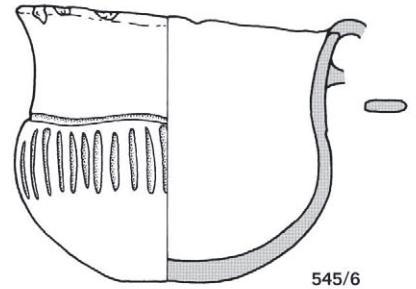

545/6

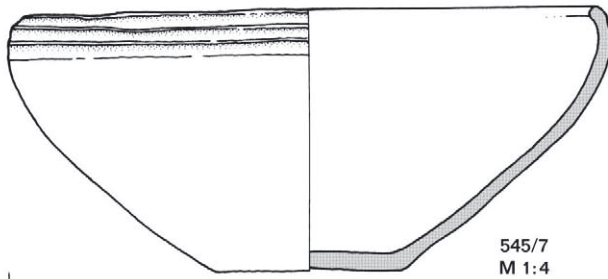

545/7
M 1:4

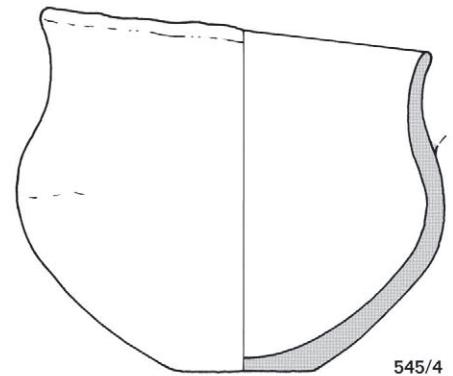

545/4

GRAB 545

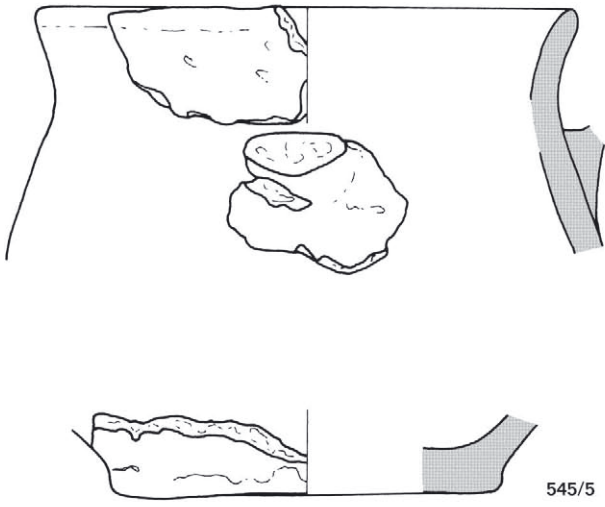

545/5

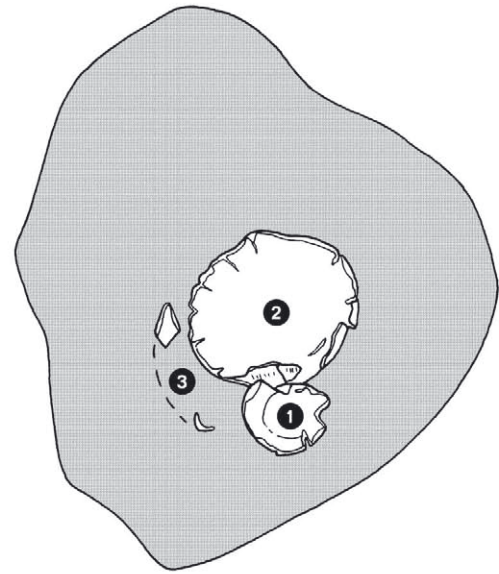

GRAB 551

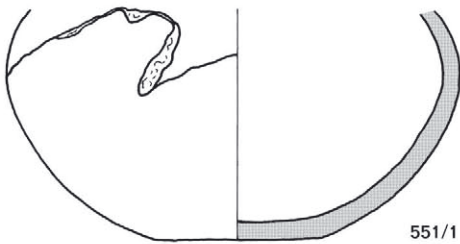

551/1

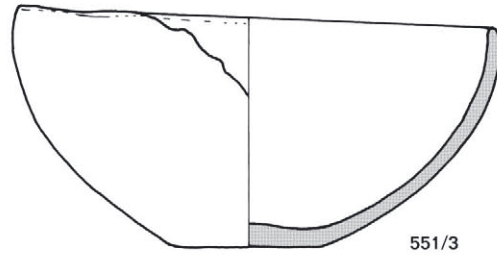

551/3

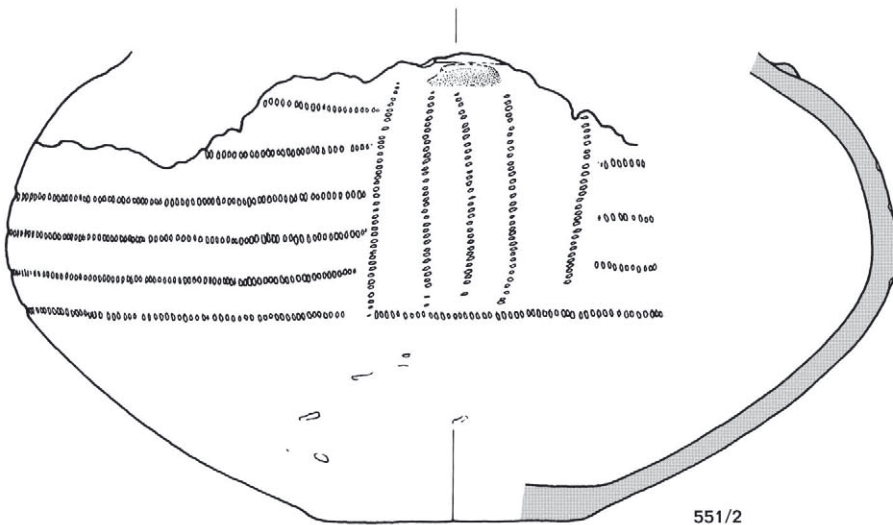

551/2

GRAB 549

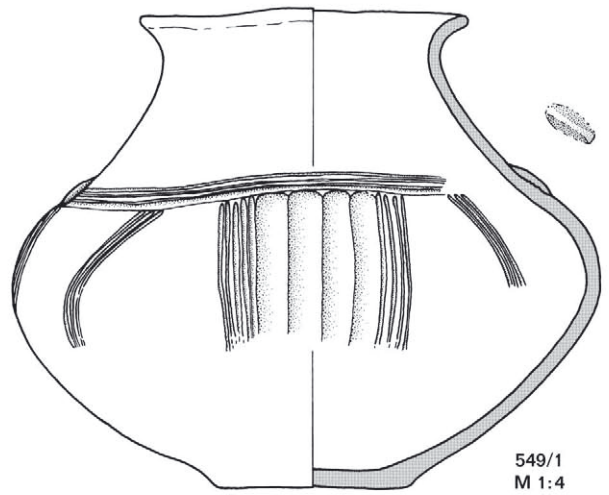
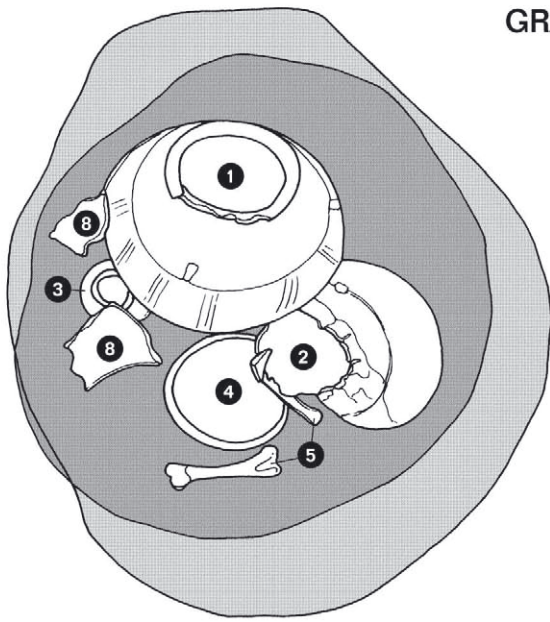

549/1
M 1:4

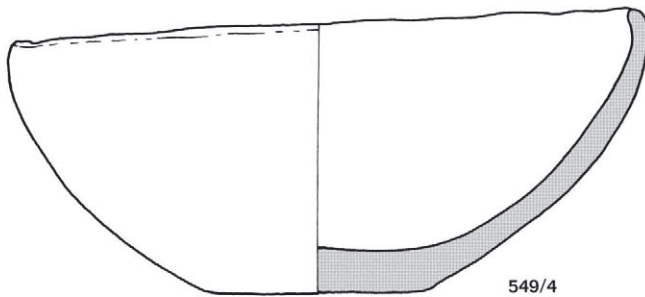

549/4

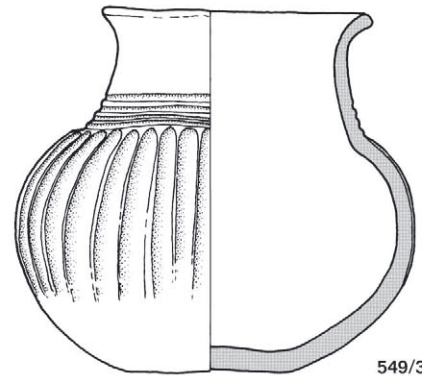

549/3

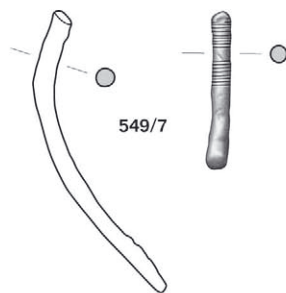
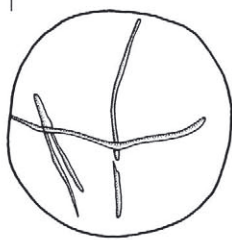

549/7

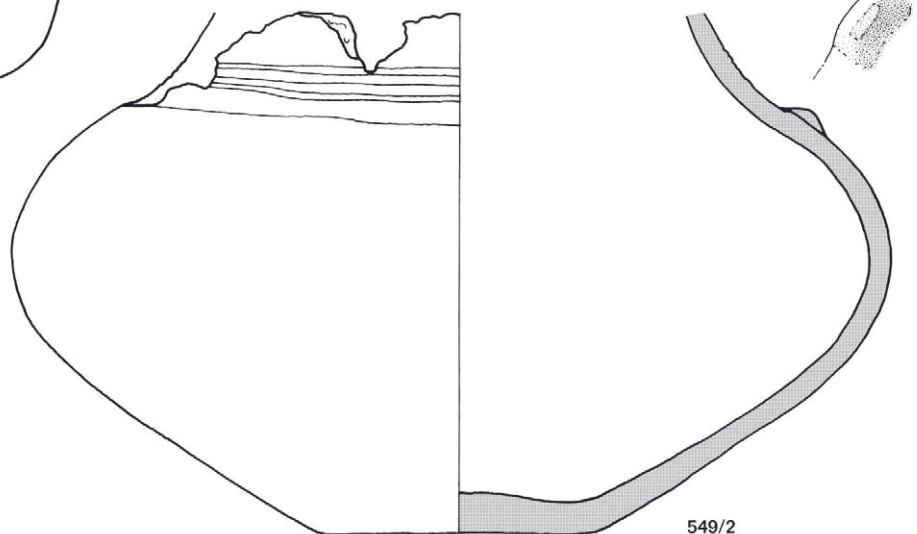

549/2

GRAB 549

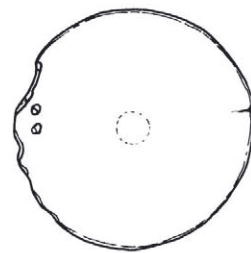
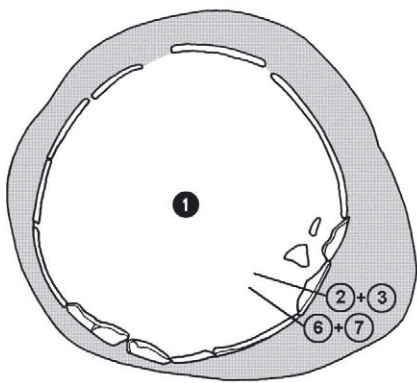
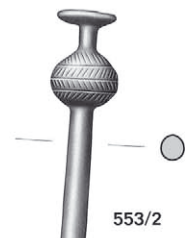
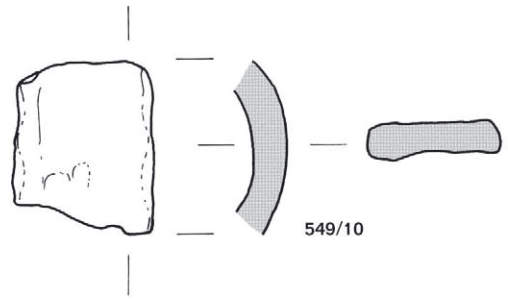
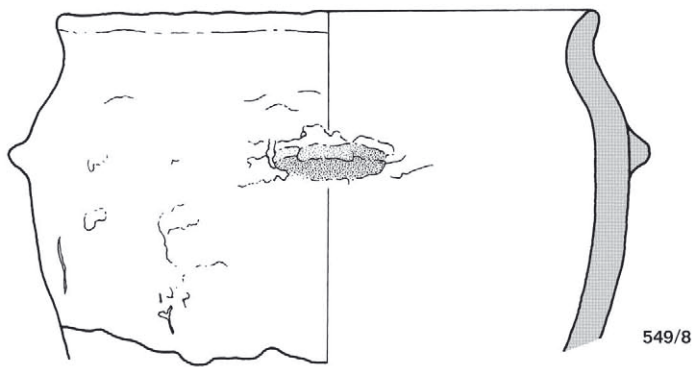

GRAB 553

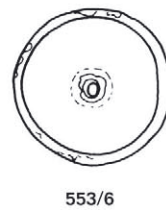
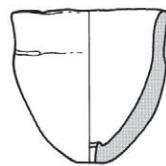
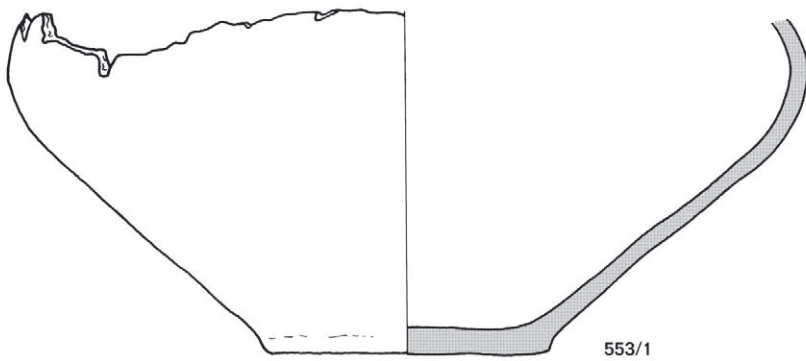
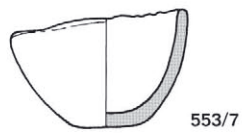

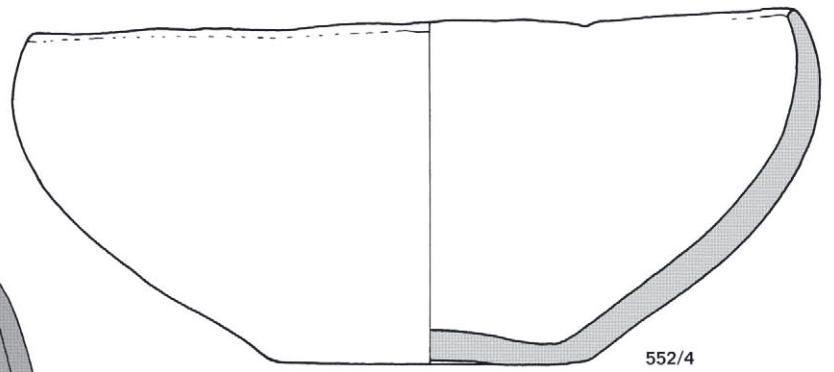
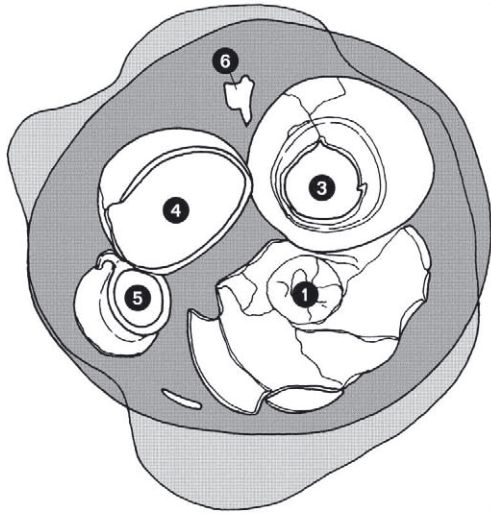

552/4

GRAB 552

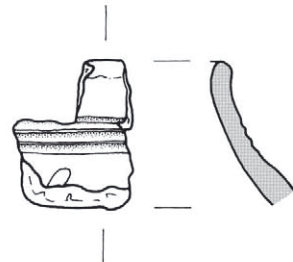

552/6

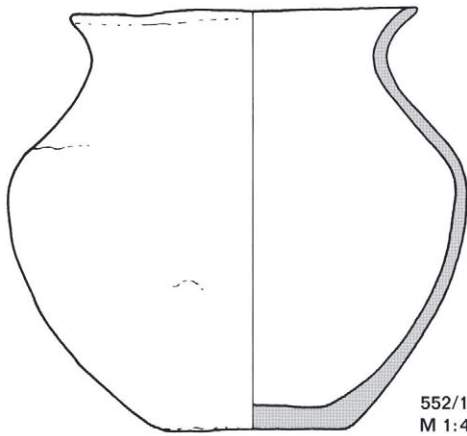

552/1
M 1:4

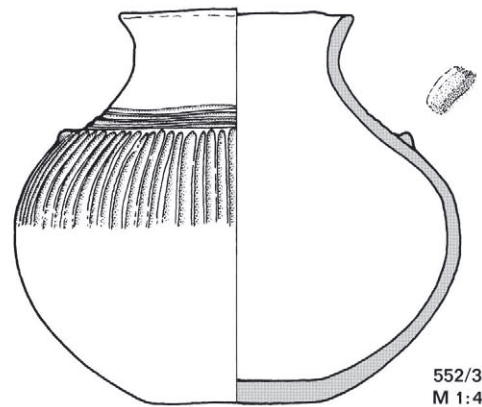

552/3
M 1:4

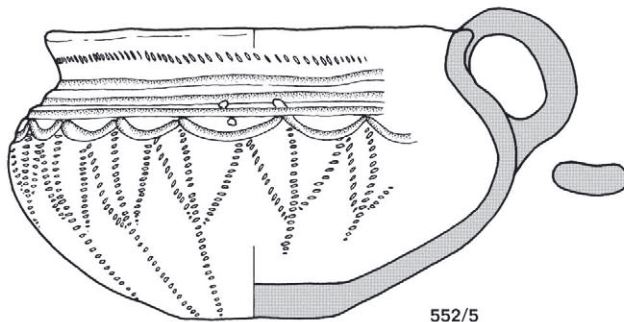

552/5

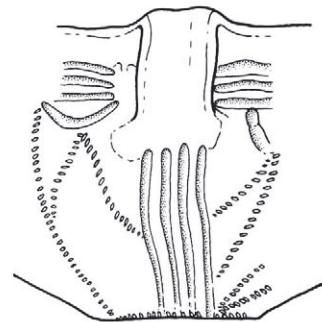

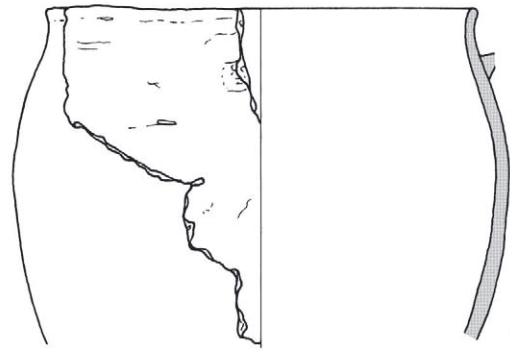
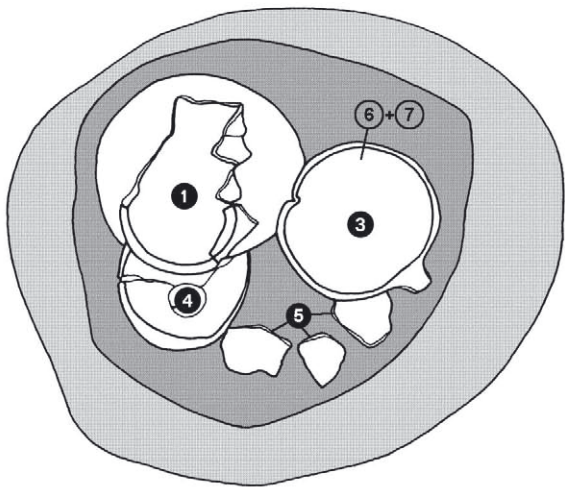

554/5
M 1:4

GRAB 554

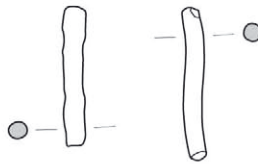

554/6

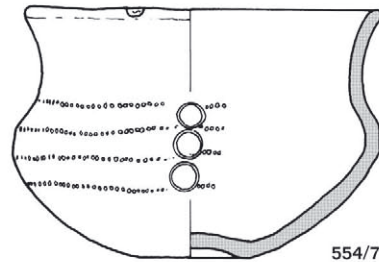

554/7

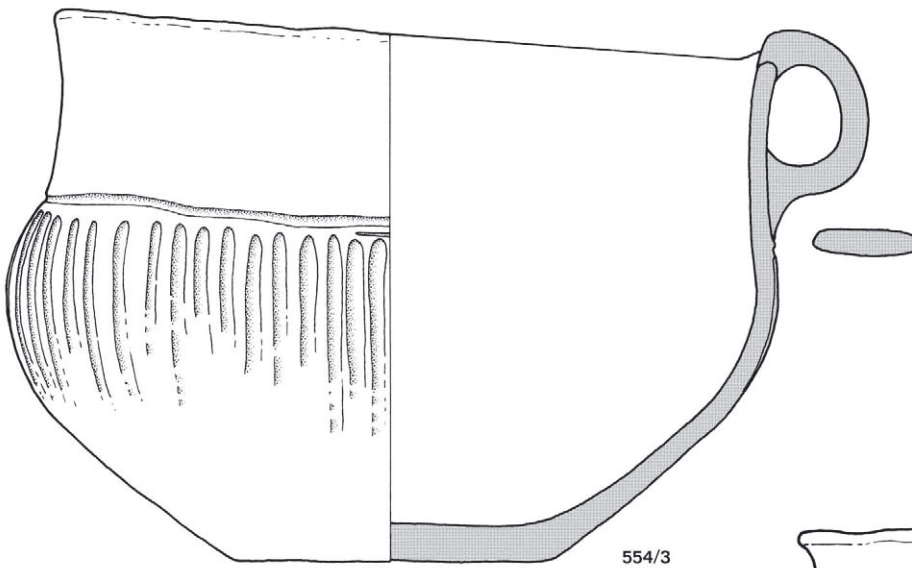

554/3

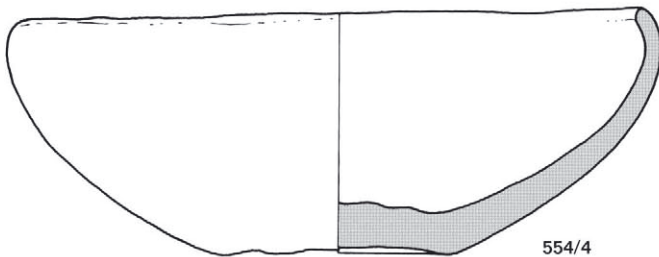

554/4

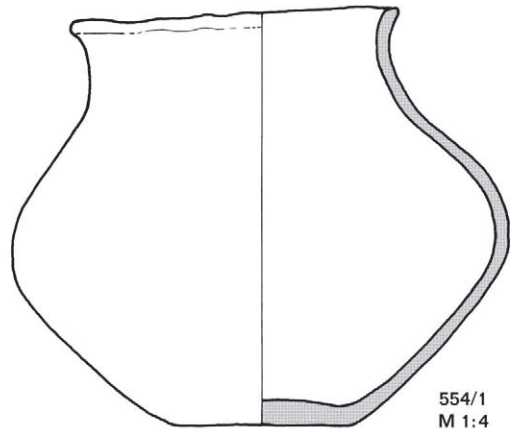

554/1
M 1:4

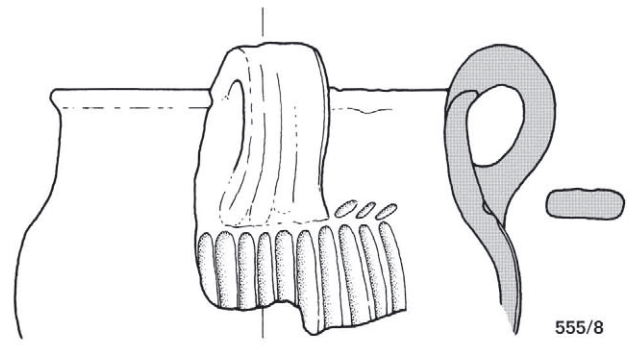
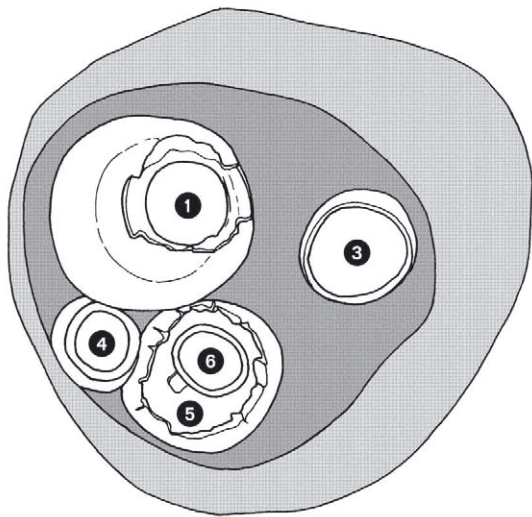

555/8

GRAB 555

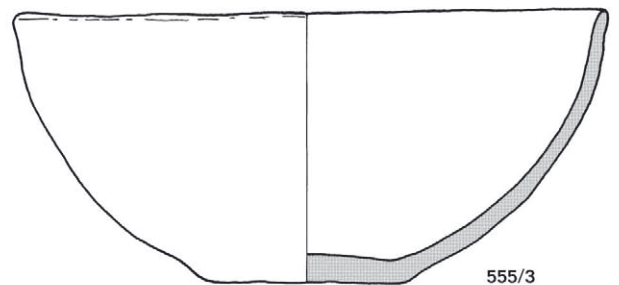

555/3

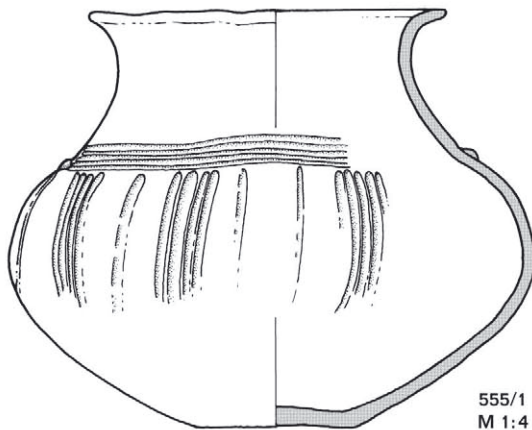

555/1
M 1:4

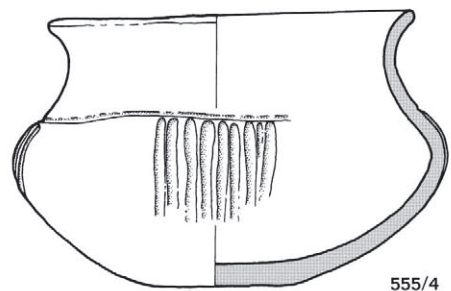

555/4

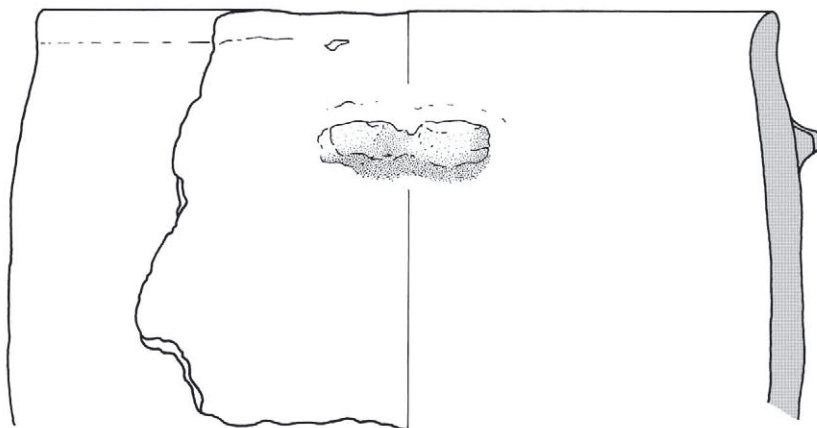

555/7

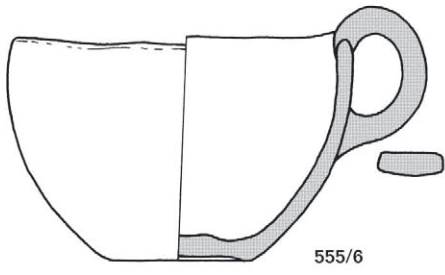

GRAB 555

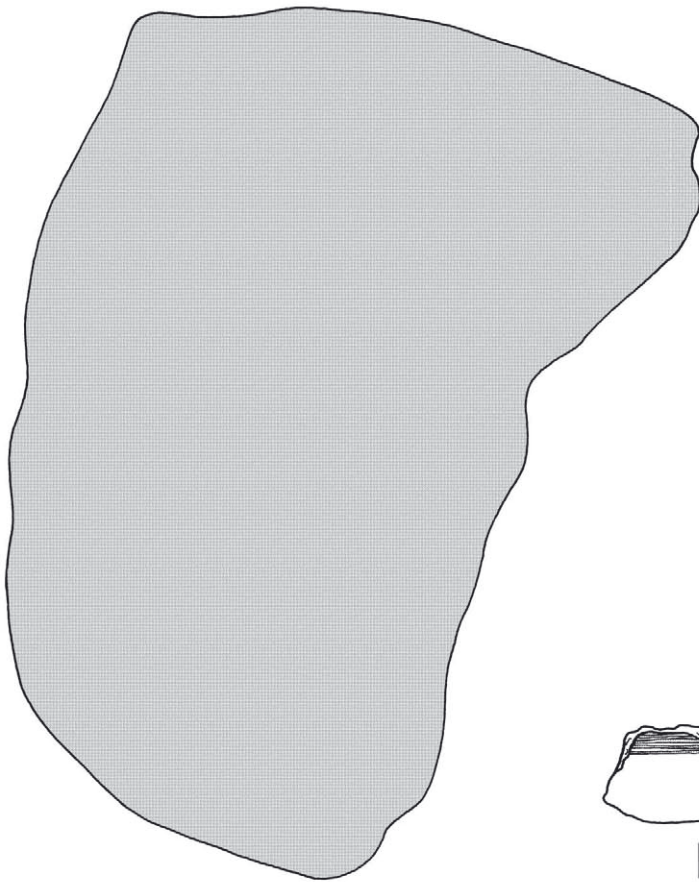
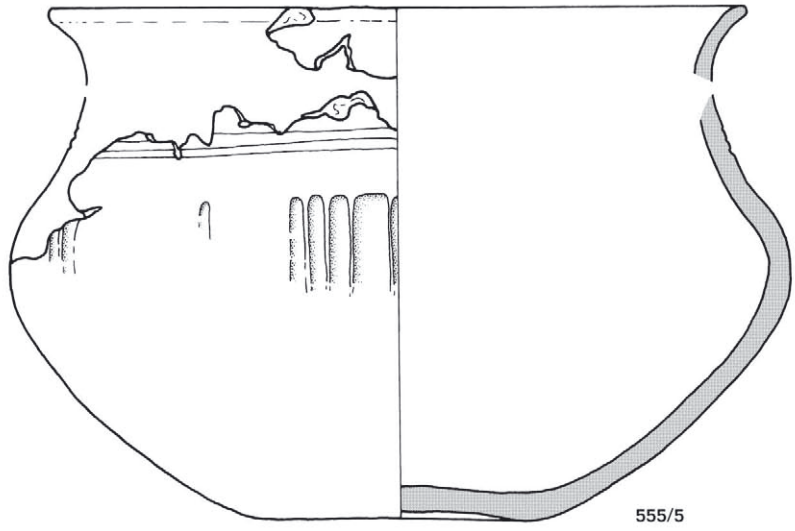

GRAB 556

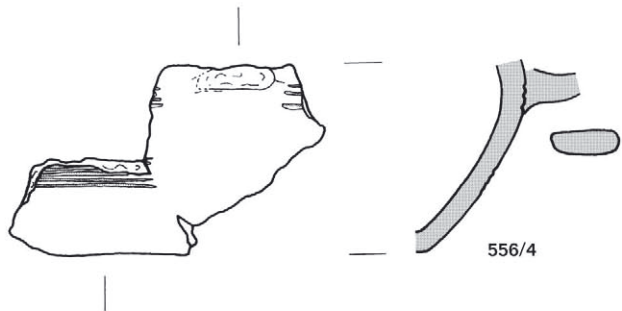
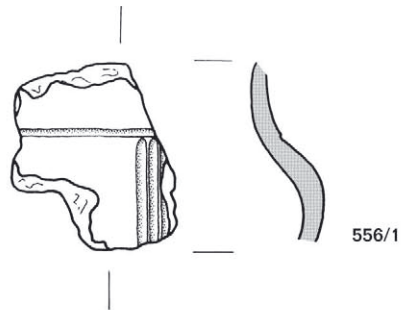

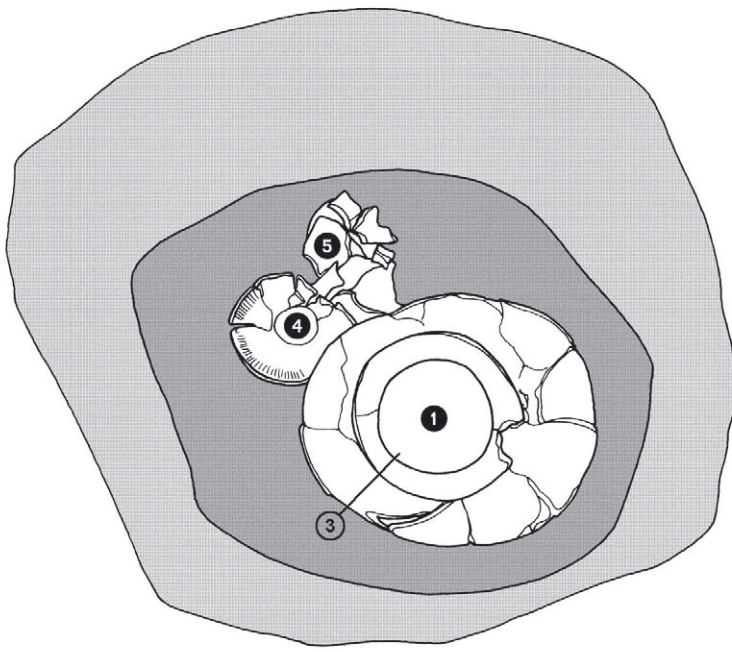

GRAB 559



559/3

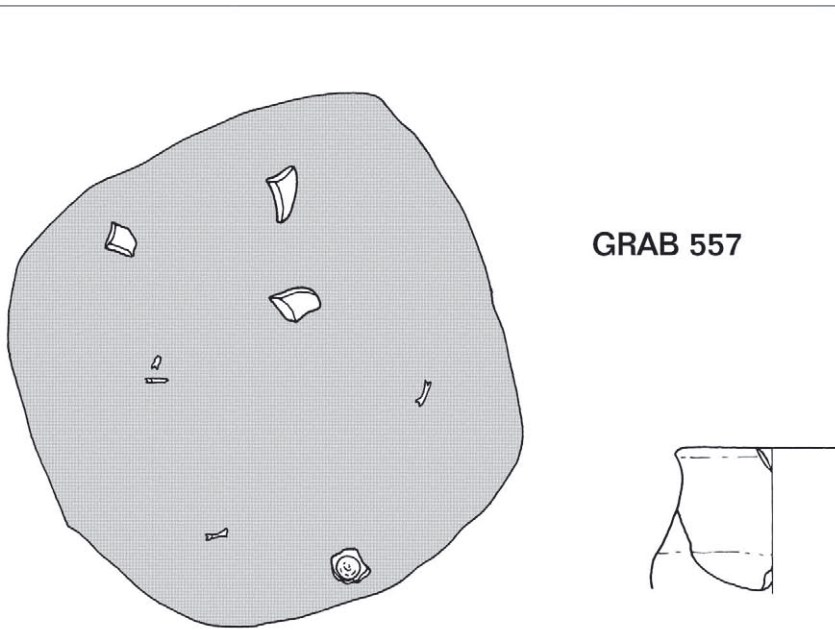

GRAB 557

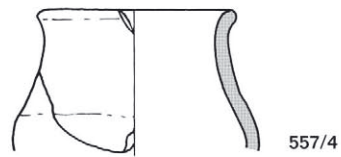

557/4

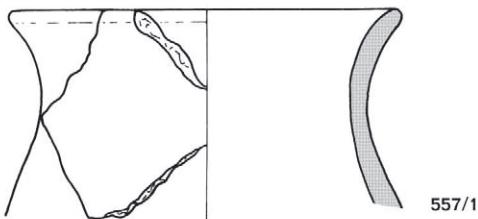

557/1

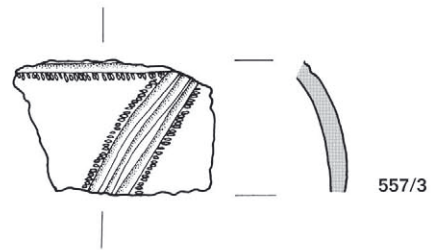

557/3

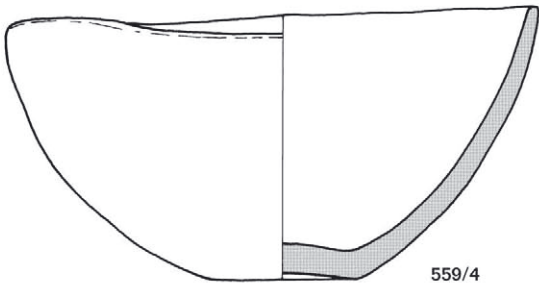

559/4

GRAB 559

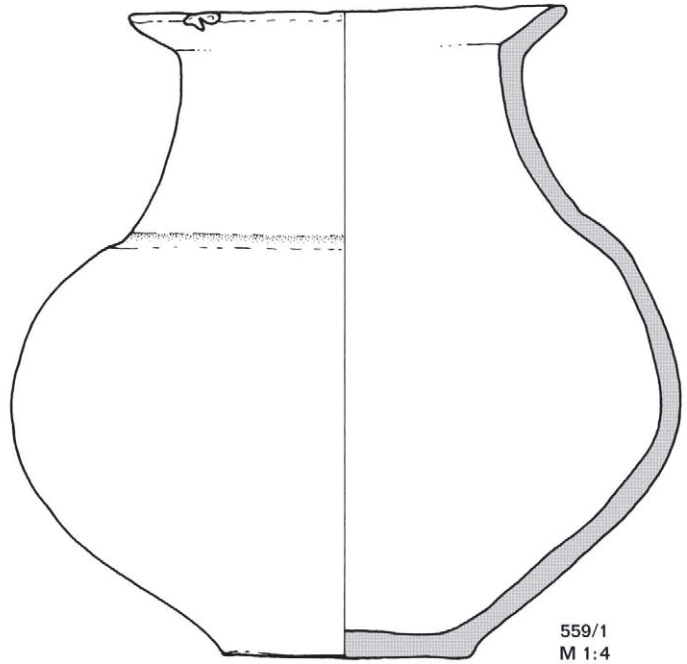

559/1
M 1:4

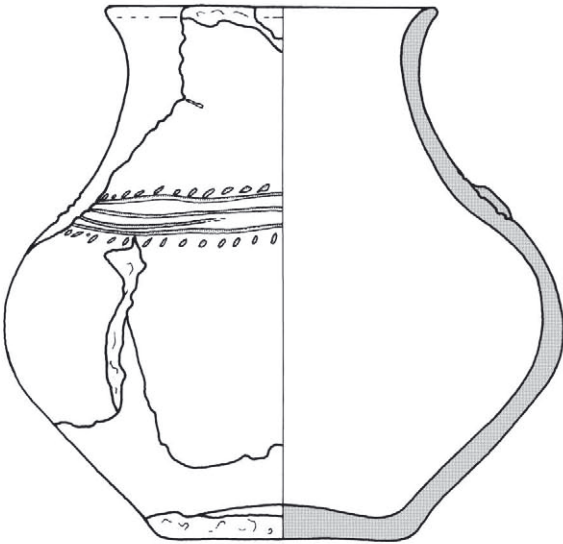

559/5



GRAB 560

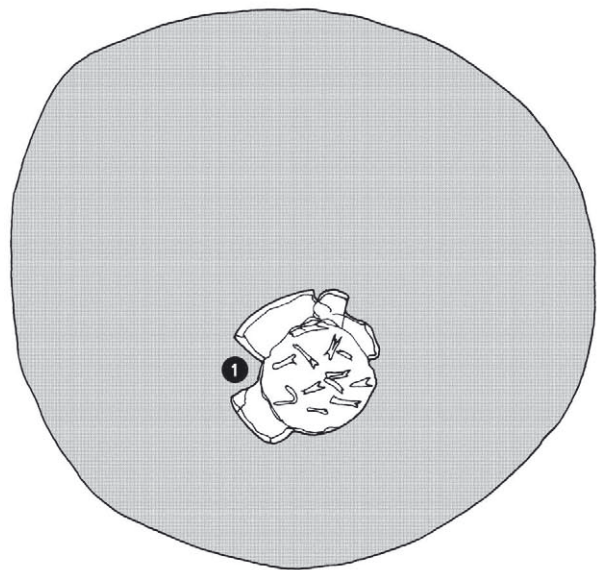

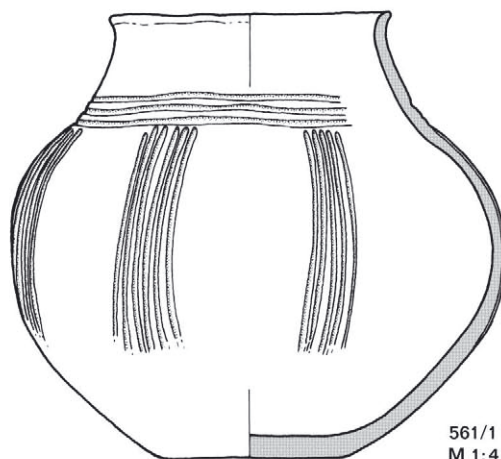
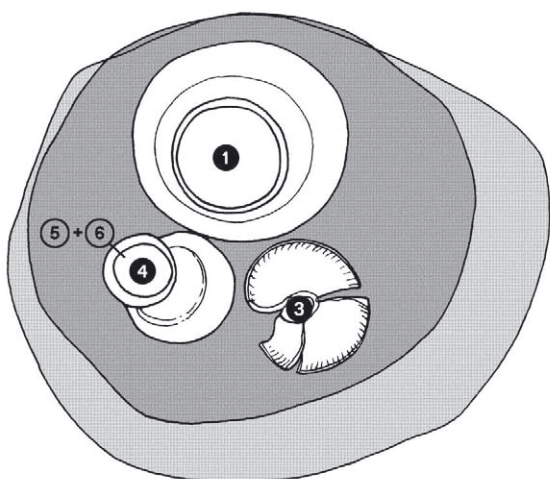

561/1
M 1:4

GRAB 561



561/5+6

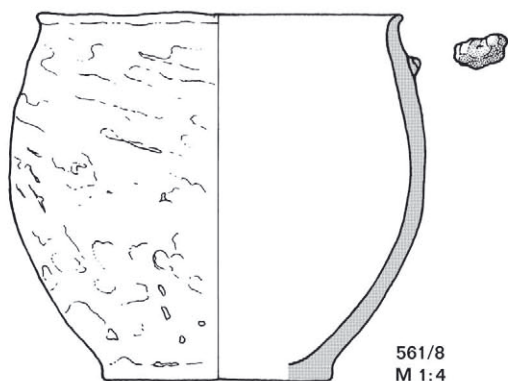

561/8
M 1:4

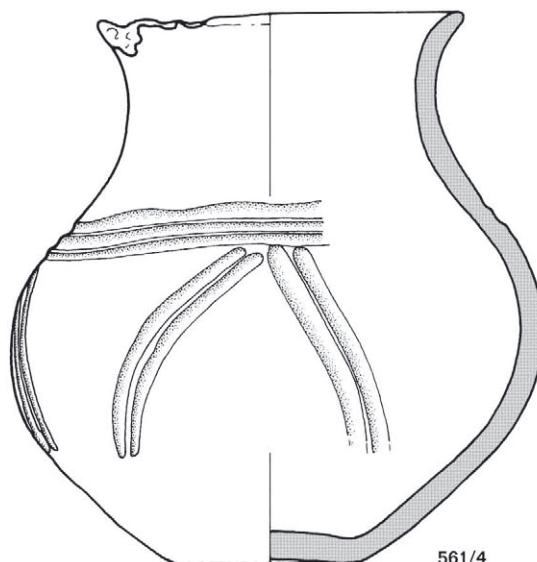

561/4

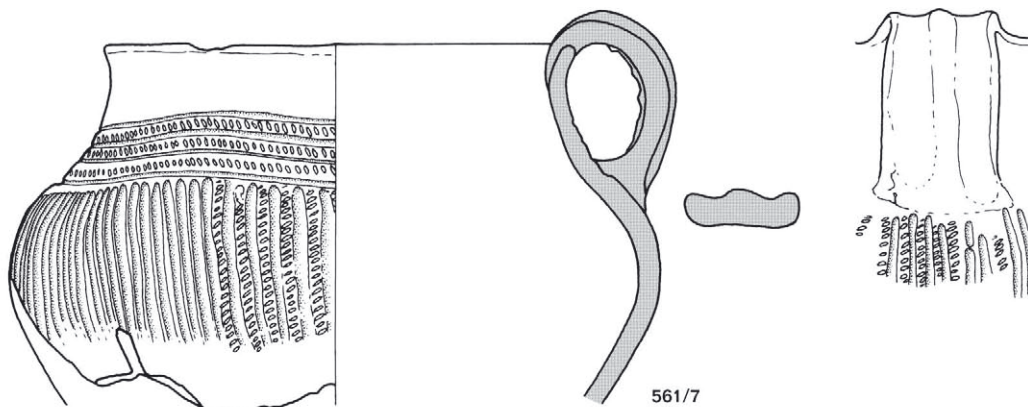

561/7

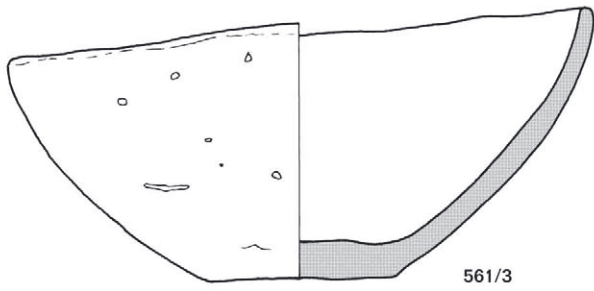

561/3

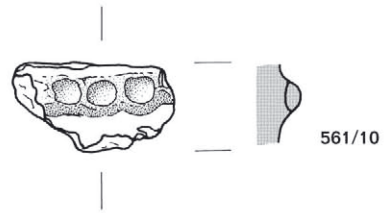

561/10

GRAB 561

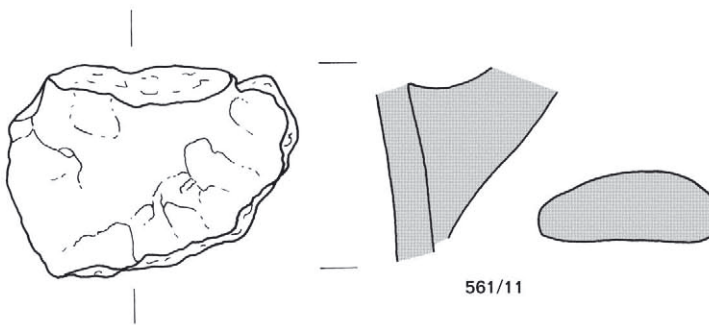

561/11

GRAB 565

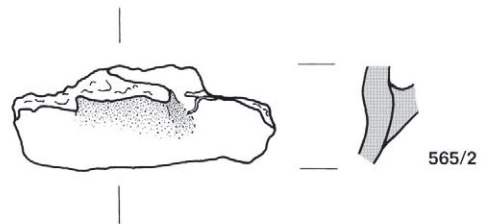
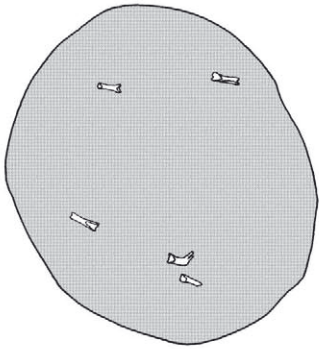

565/2

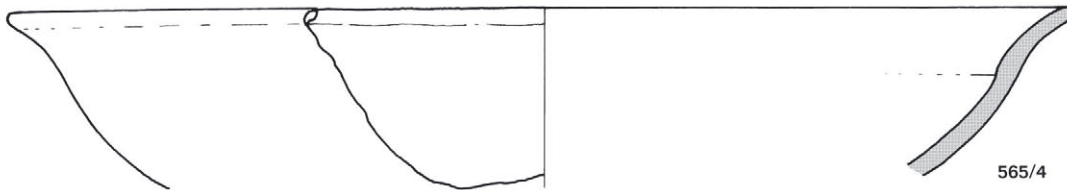

565/4

GRAB 564

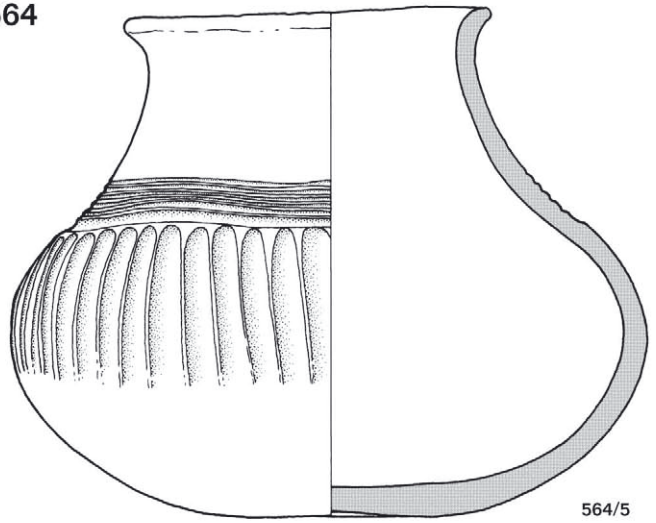
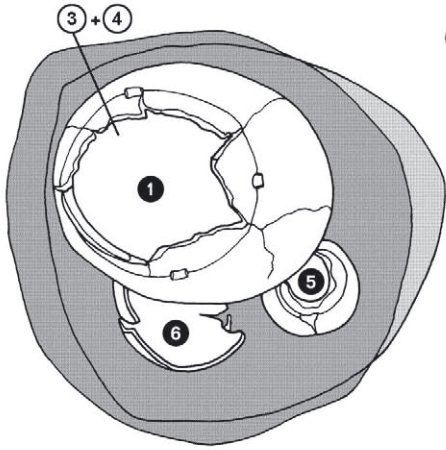

564/5



564/3

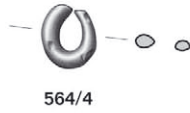

564/4



564/7

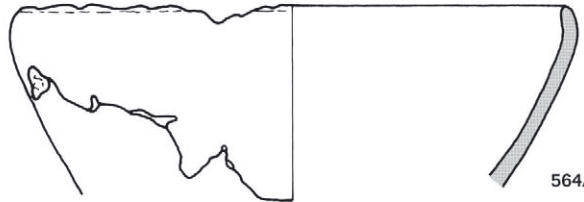

564/6

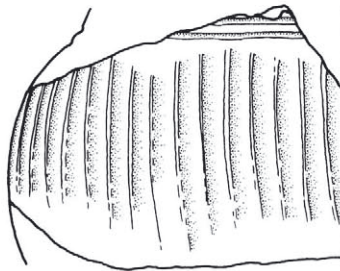

564/11

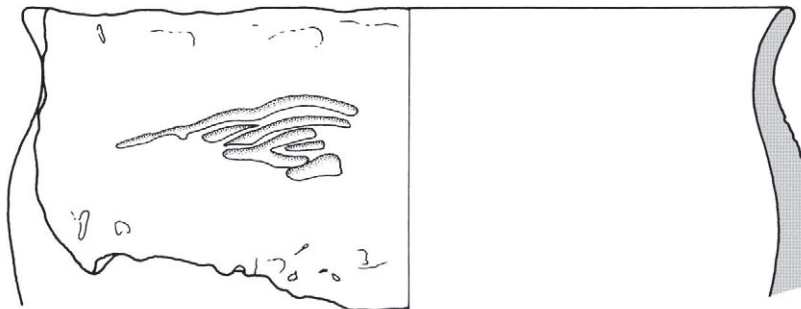

564/8

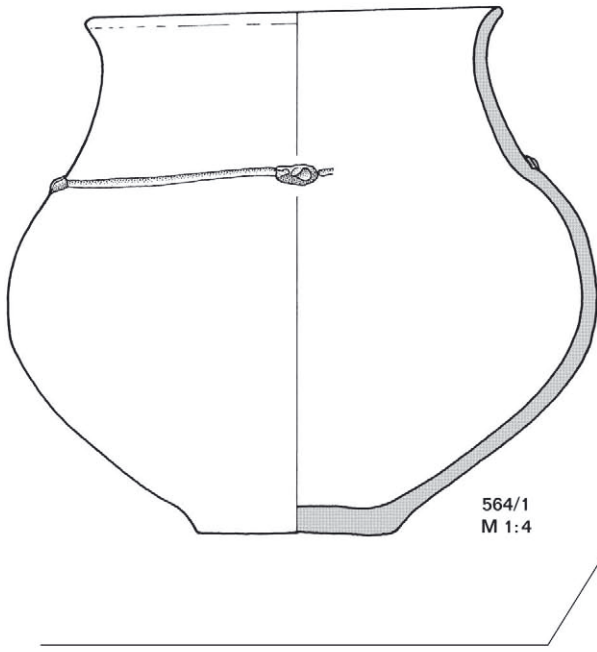

564/1
M 1:4

GRAB 564

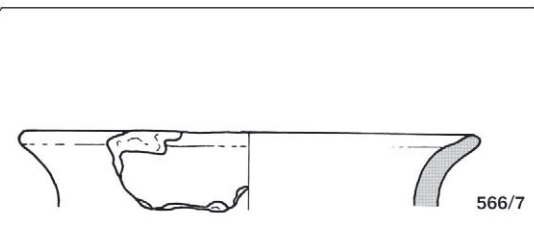

566/7

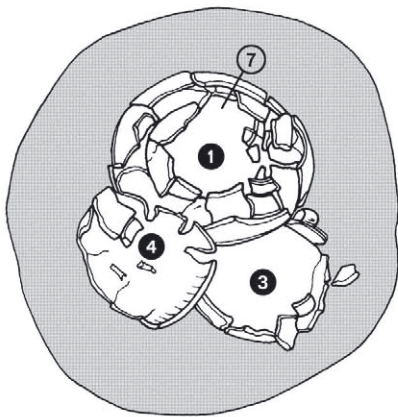

GRAB 566

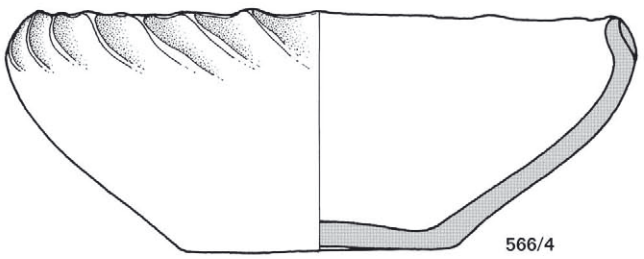

566/4

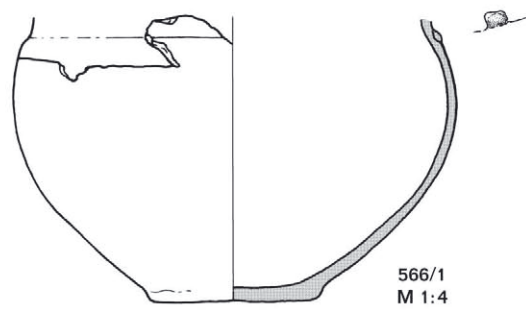

566/1
M 1:4

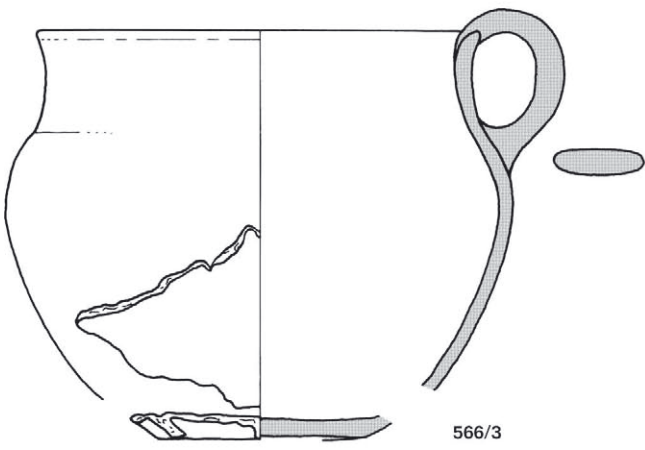

566/3

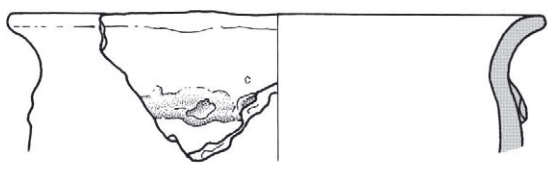

566/5

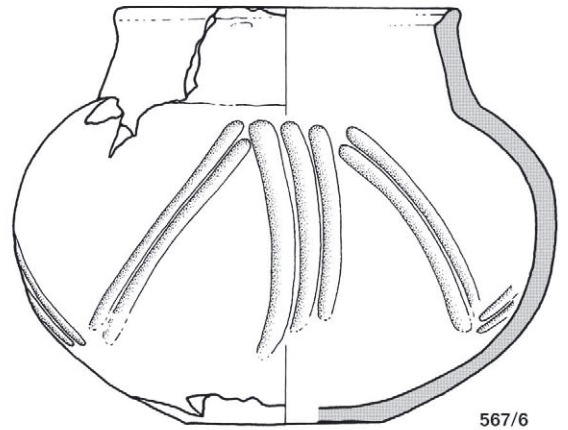
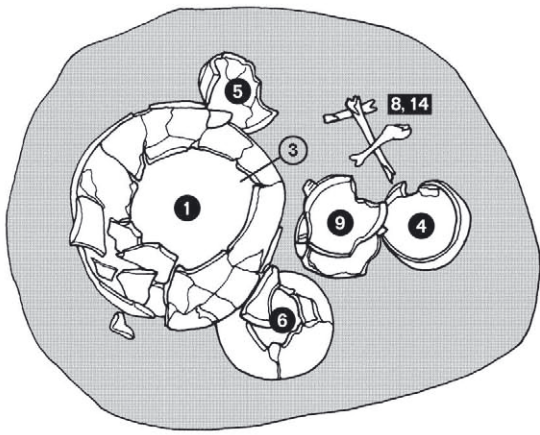

GRAB 567

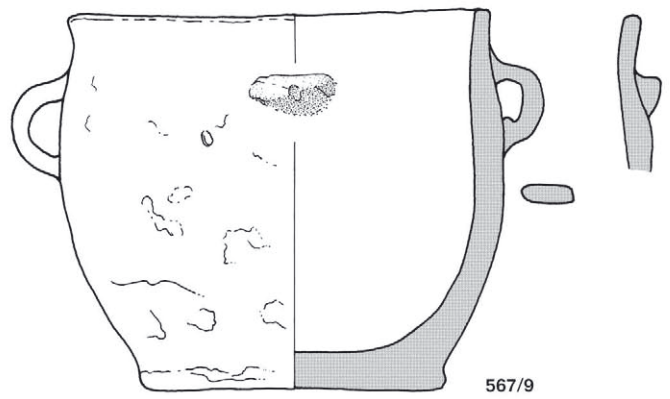
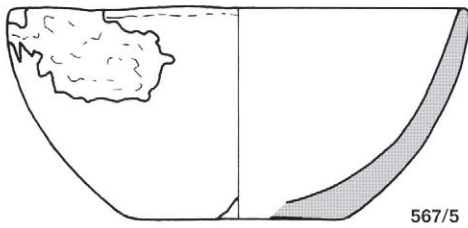
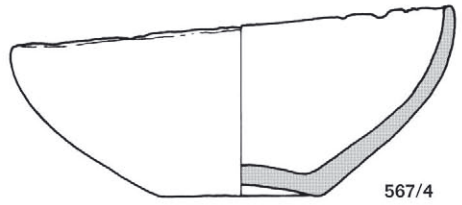
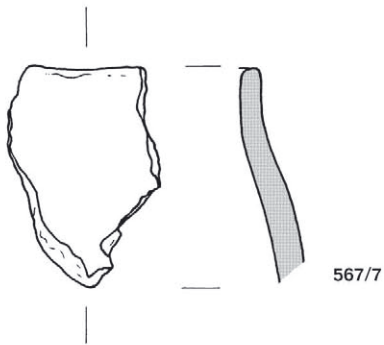
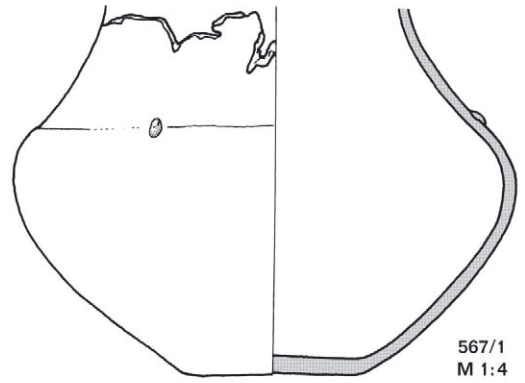
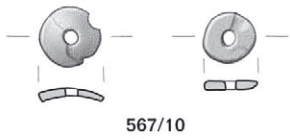

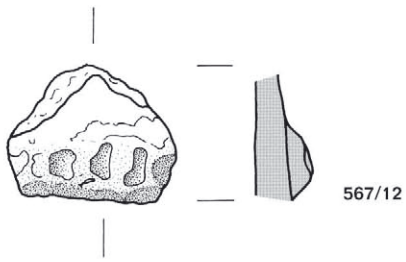

GRAB 567

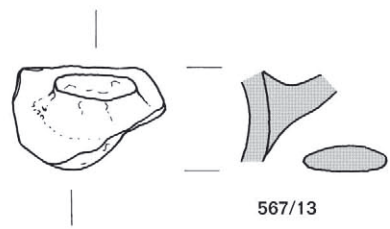

567/12

567/13

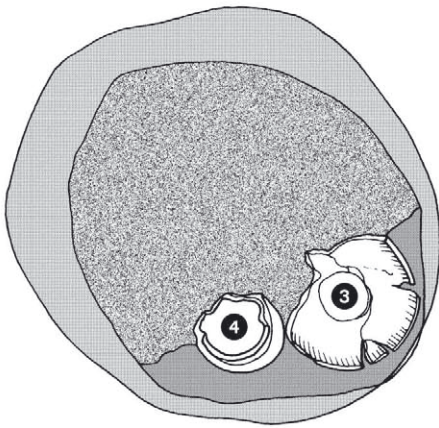

GRAB 568

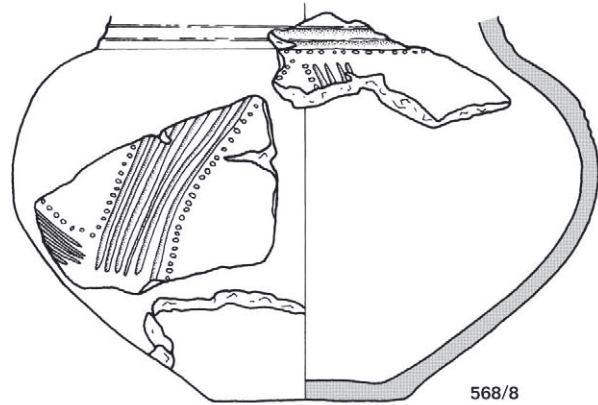

568/8

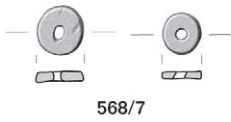

568/7



568/9



568/6

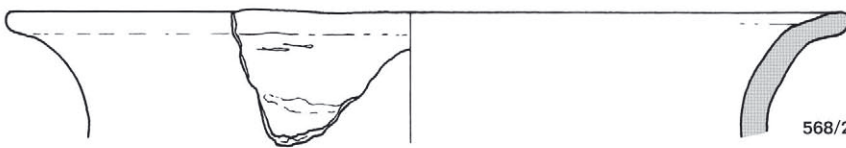

568/2

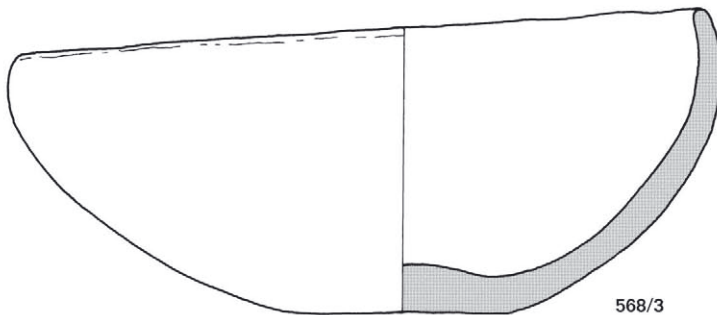

568/3

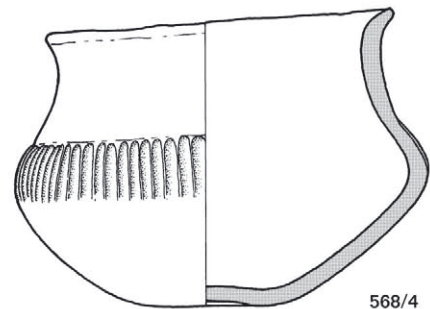

568/4

GRAB 569

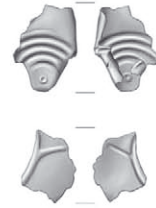
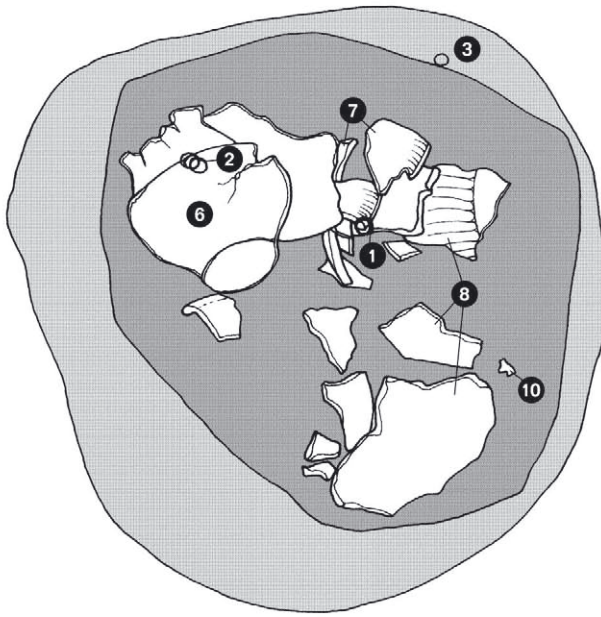

569/10
M 2:1

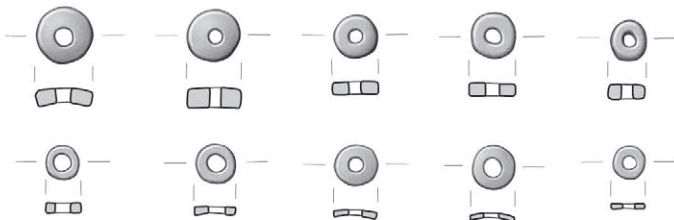

569/12

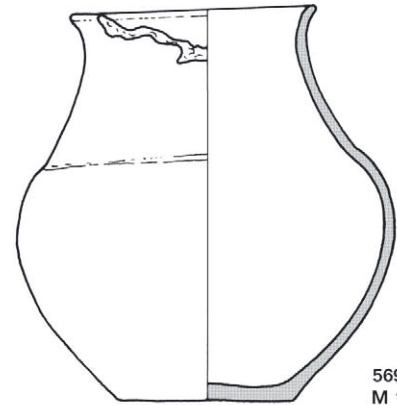

569/6
M 1:4

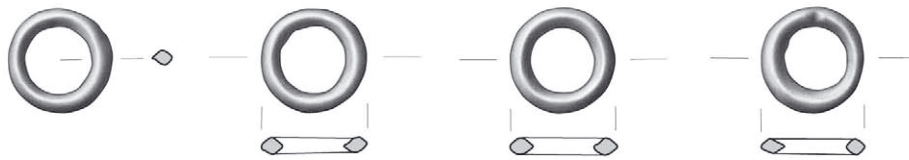

569/11

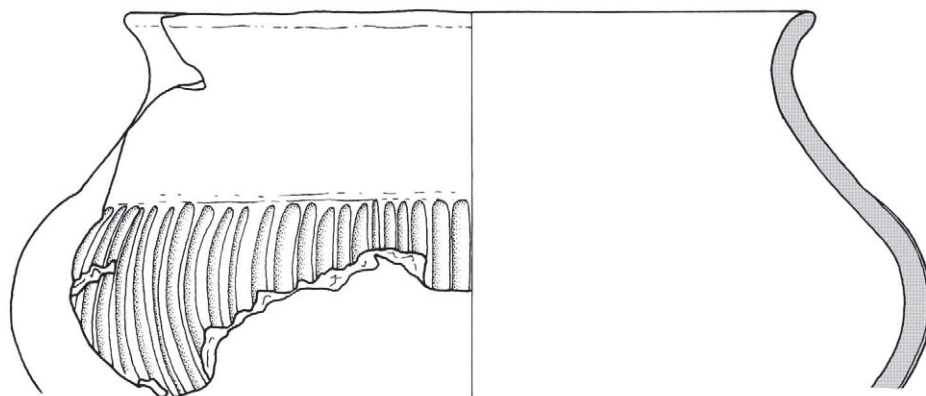

569/9
M 1:4

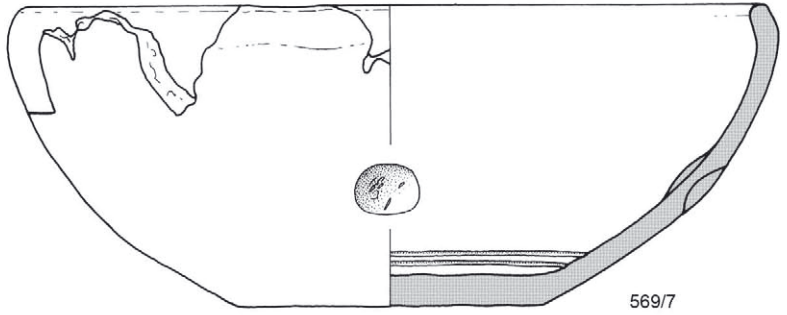
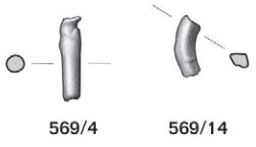

GRAB 569

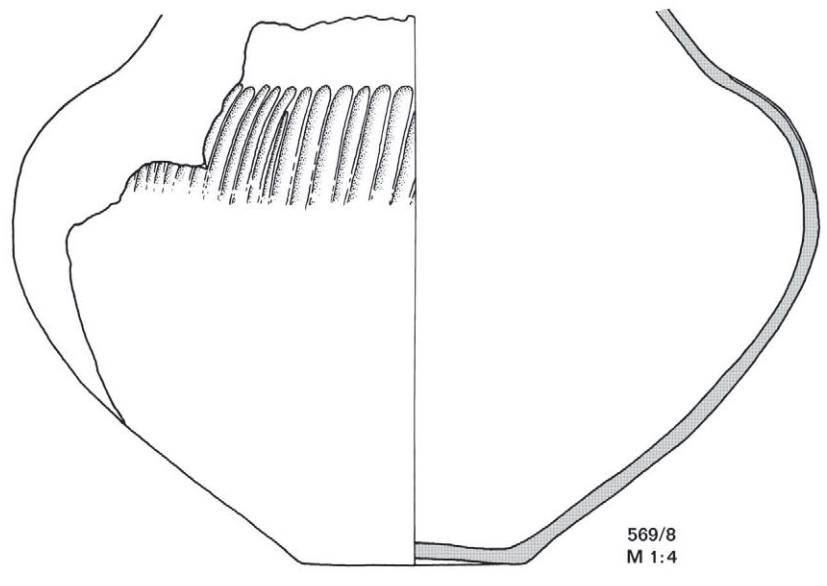
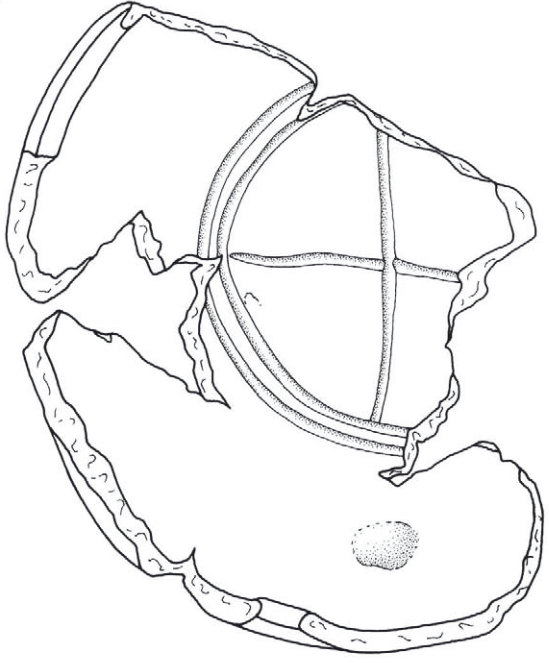
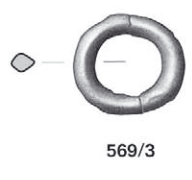

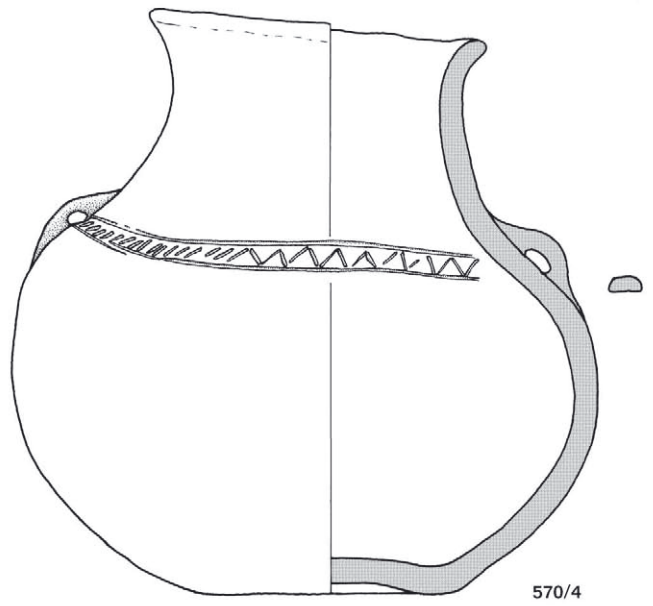
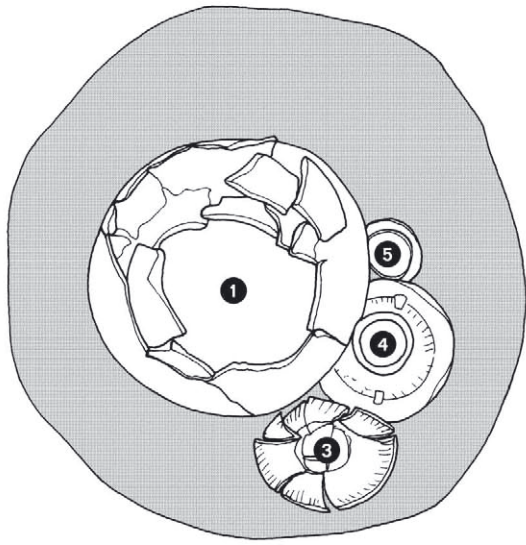

570/4

GRAB 570

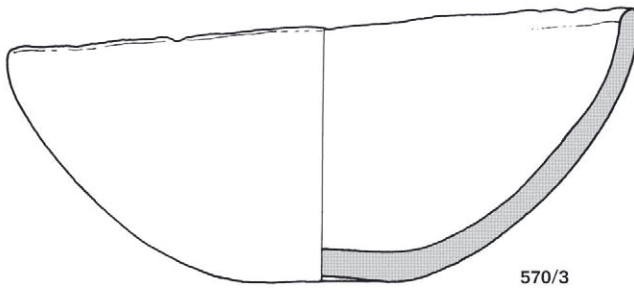

570/3

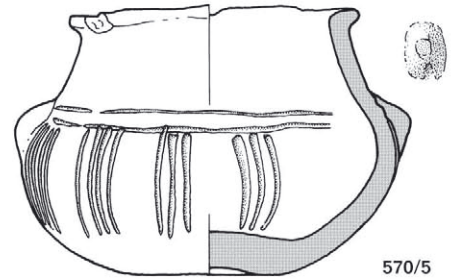

570/5

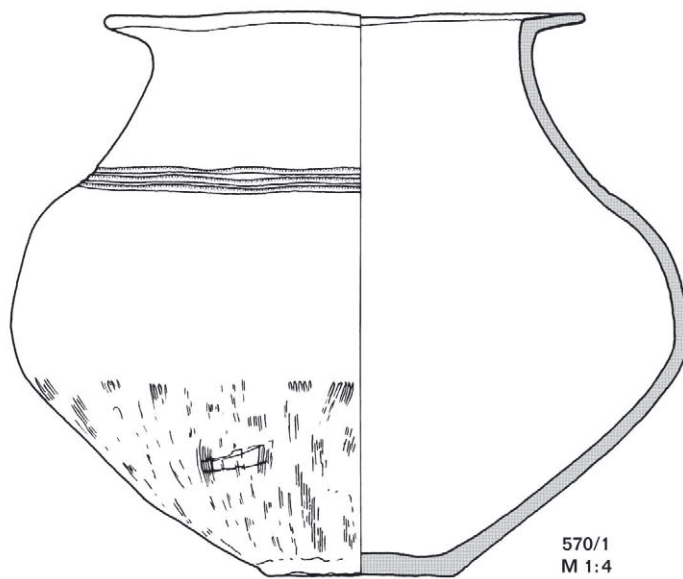

570/1
M 1:4

GRAB 571

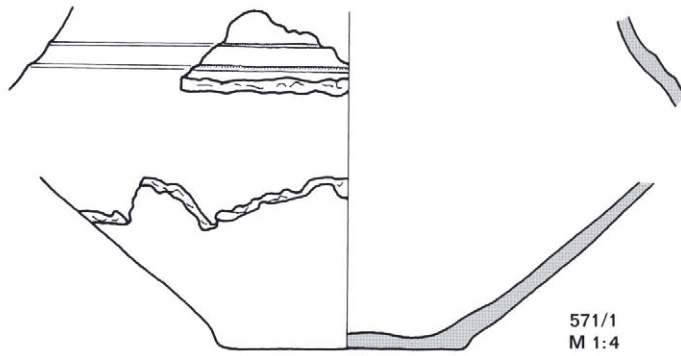
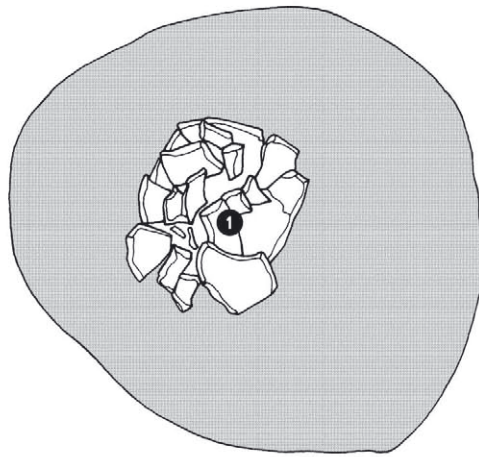

571/1
M 1:4

GRAB 575/576

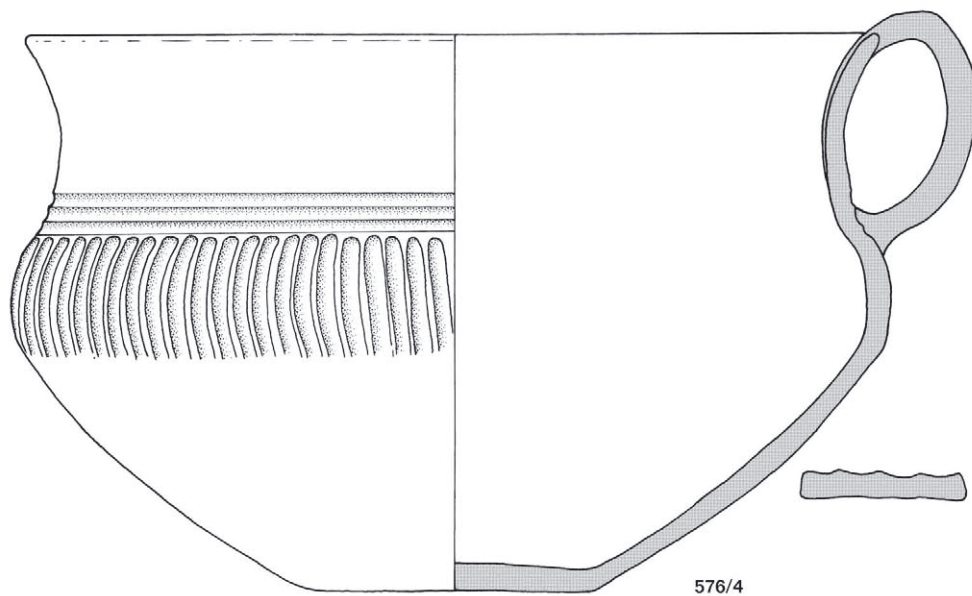

576/4

GRAB 576/575

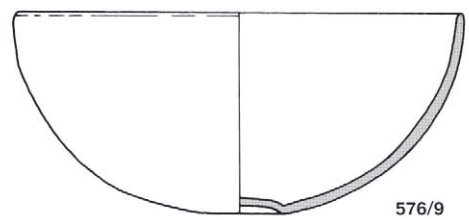
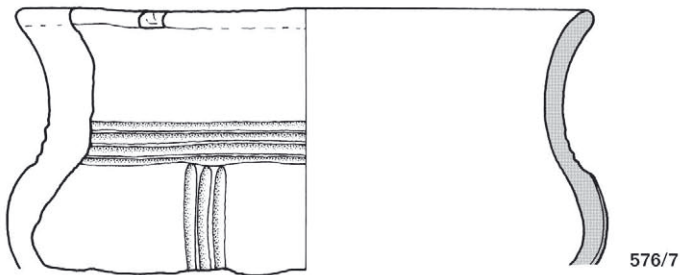
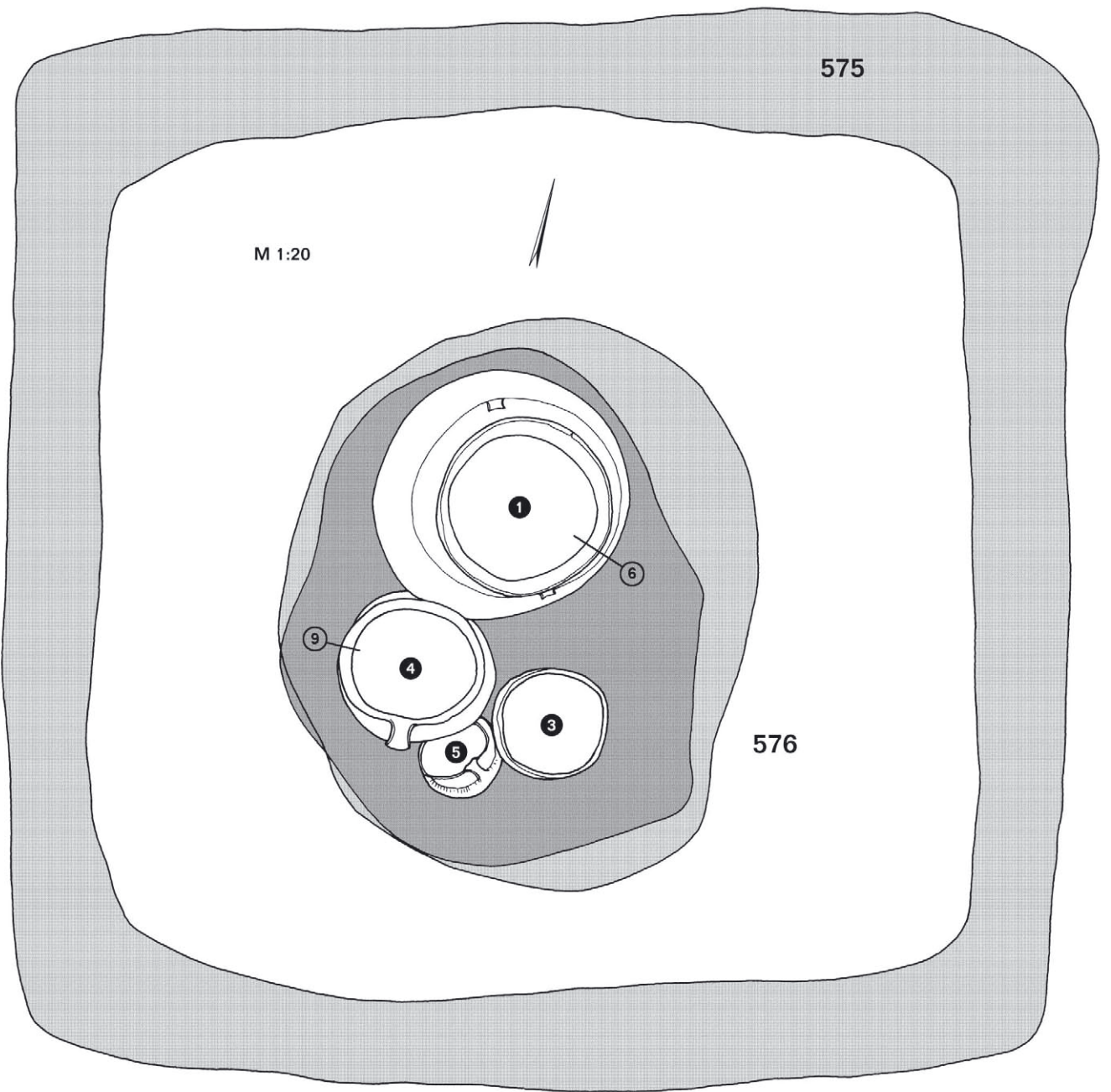

GRAB 576/575

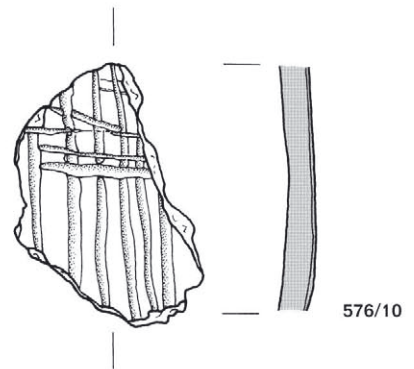
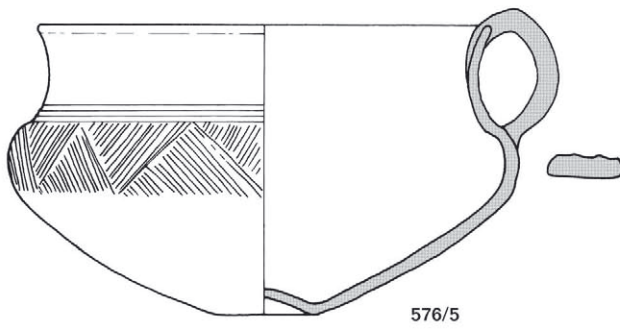
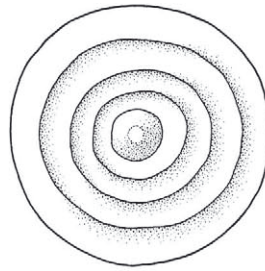
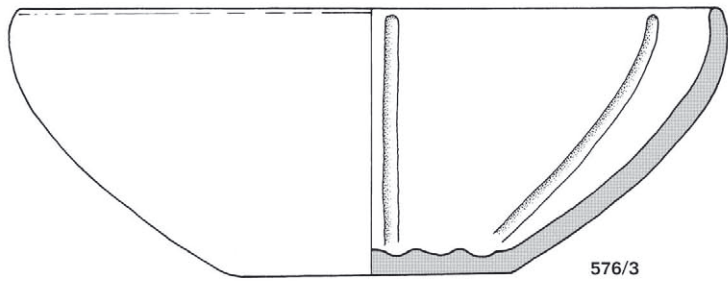
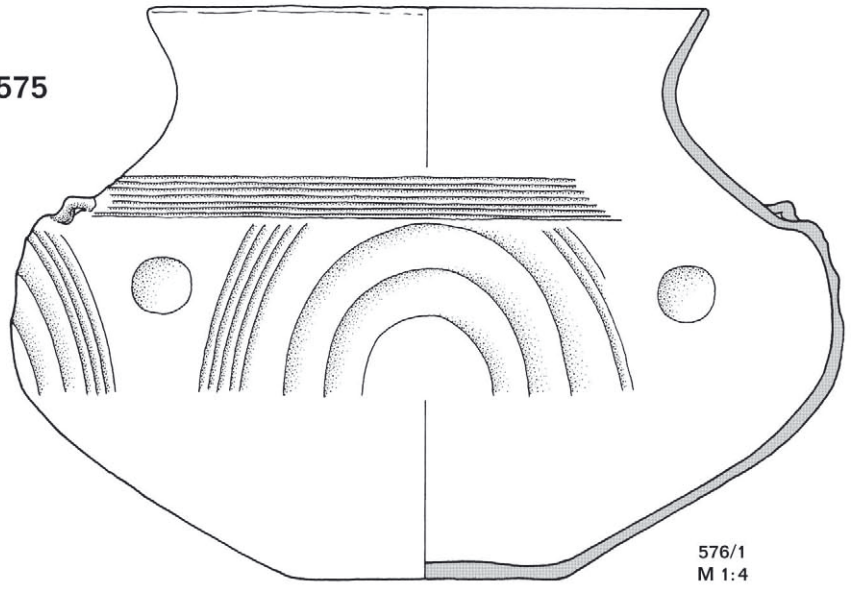

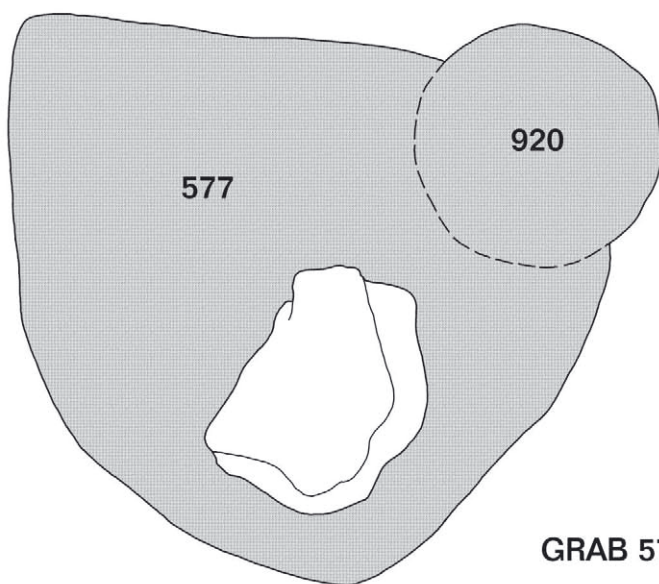

577 2. Planum

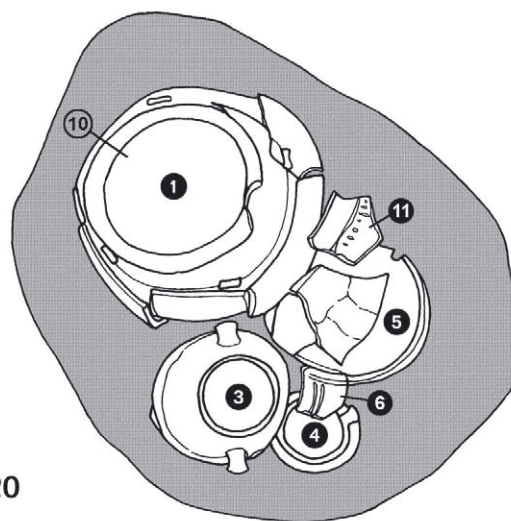

GRAB 577/920

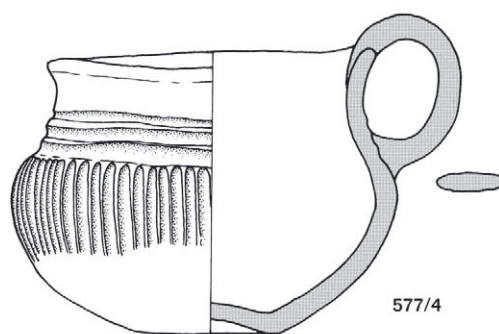
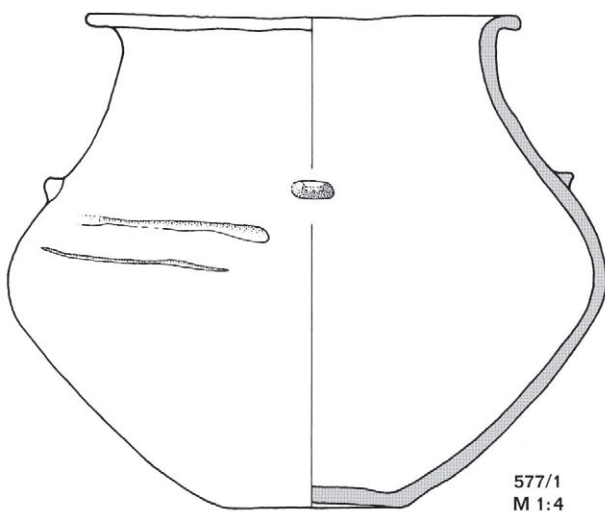
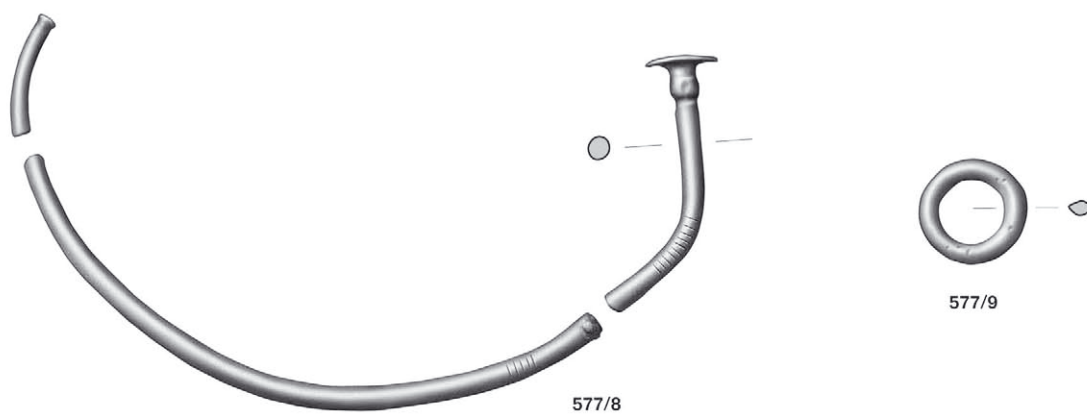

GRAB 577/920

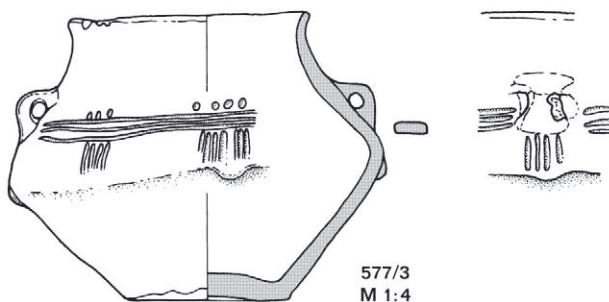

577/3
M 1:4

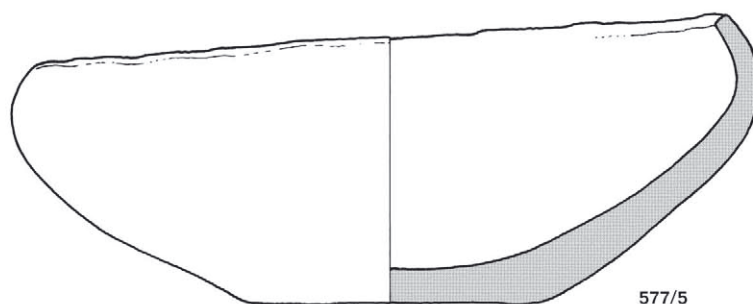

577/5

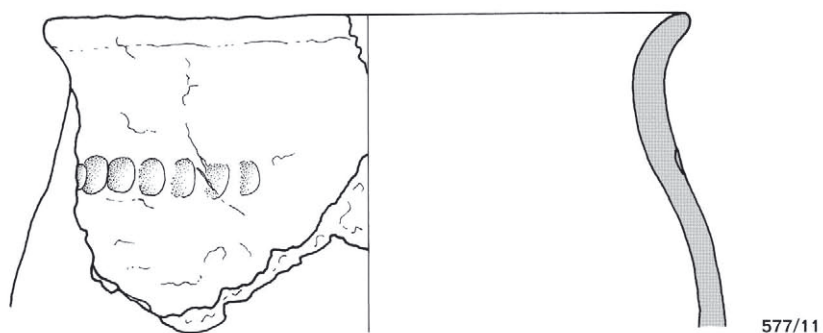

577/11

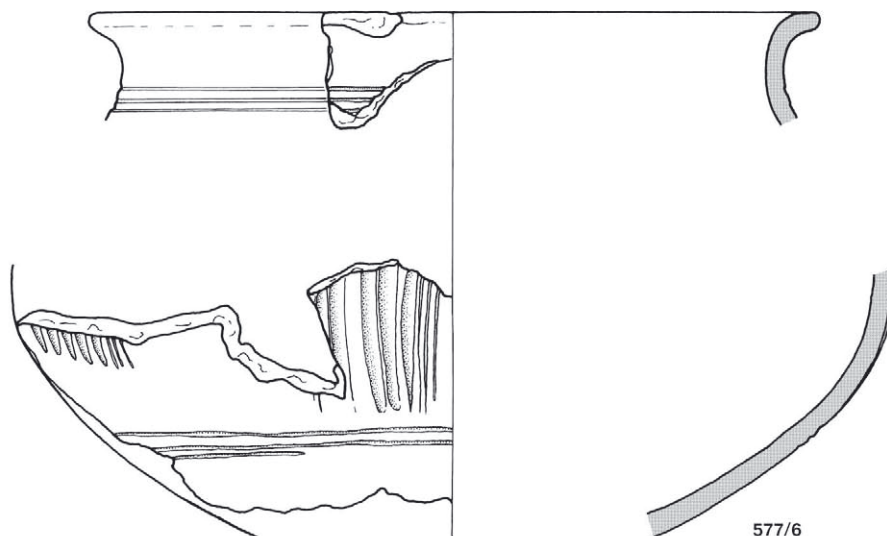

577/6

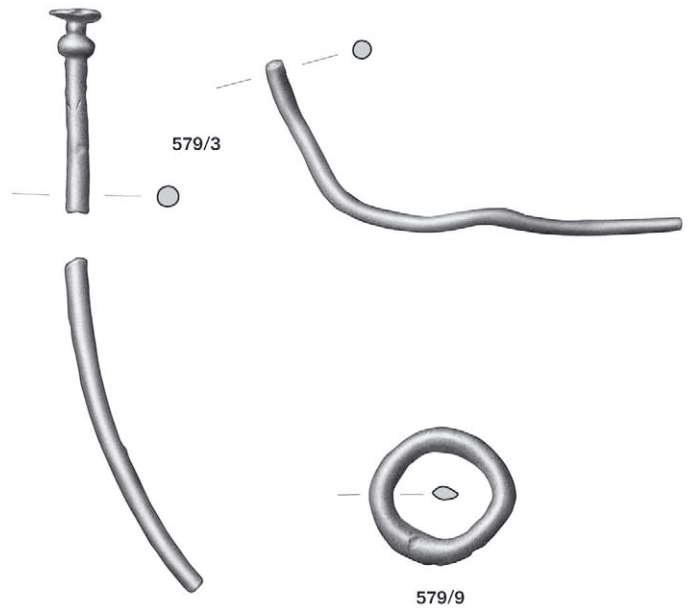
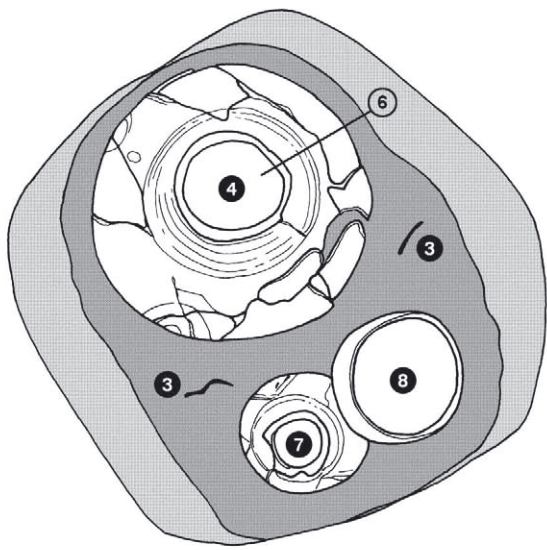

GRAB 579

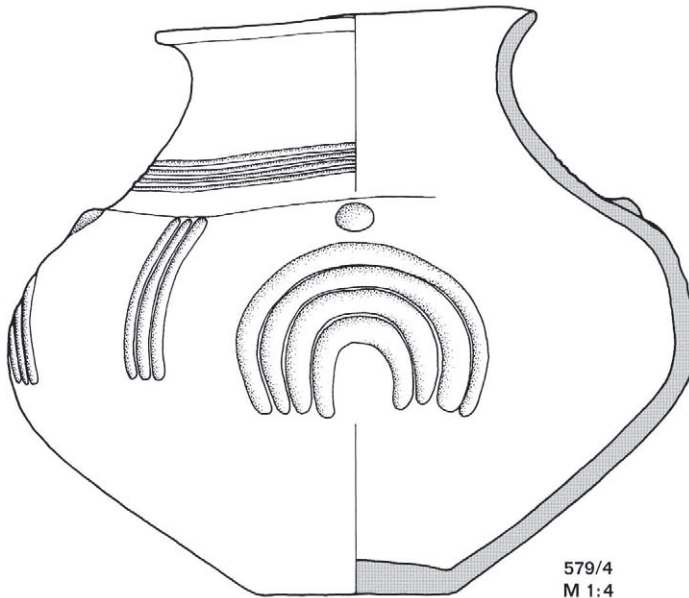
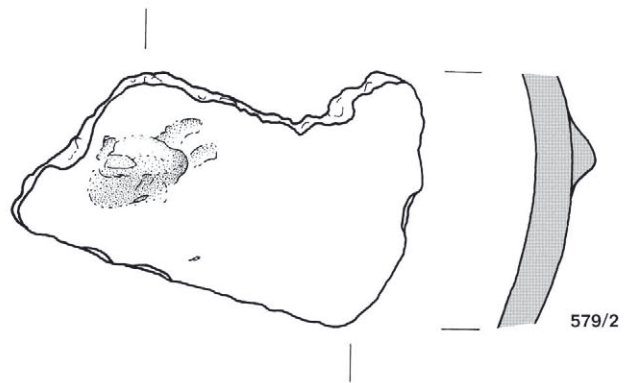
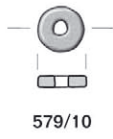

579/4
M 1:4

GRAB 579

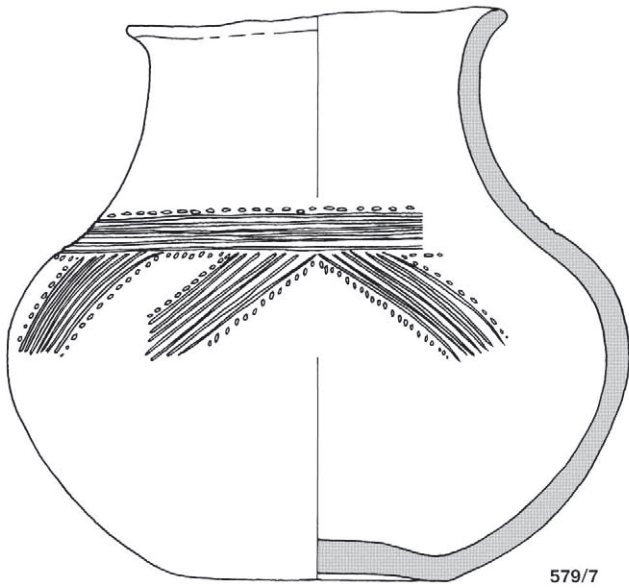

579/7

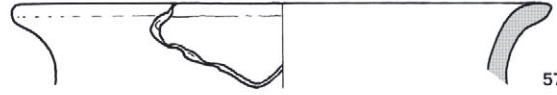

579/11

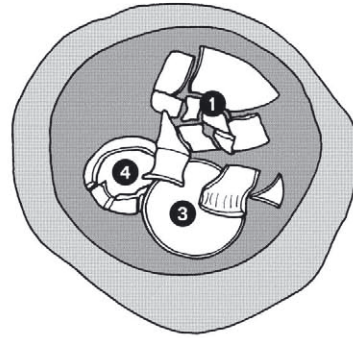

GRAB 582

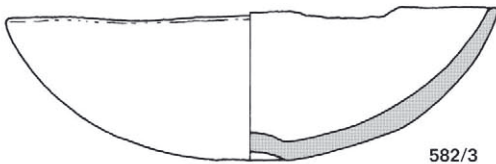

582/3



582/4

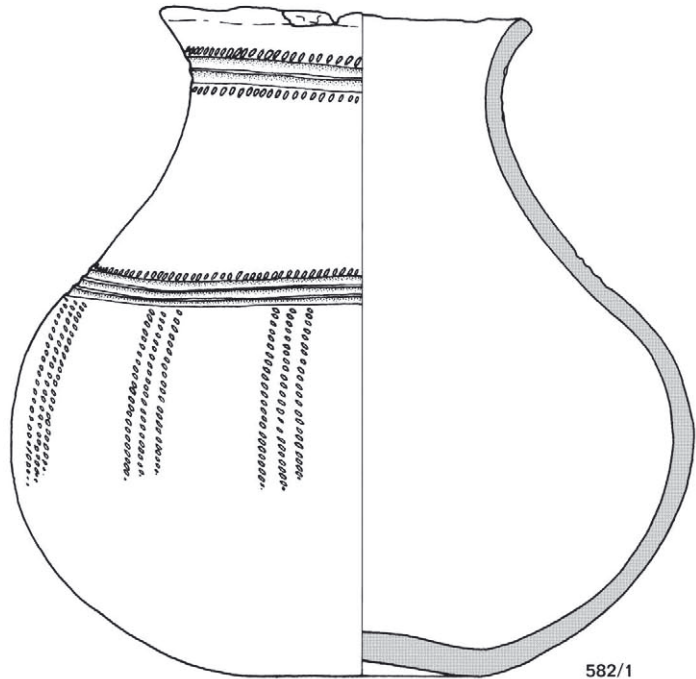

582/1

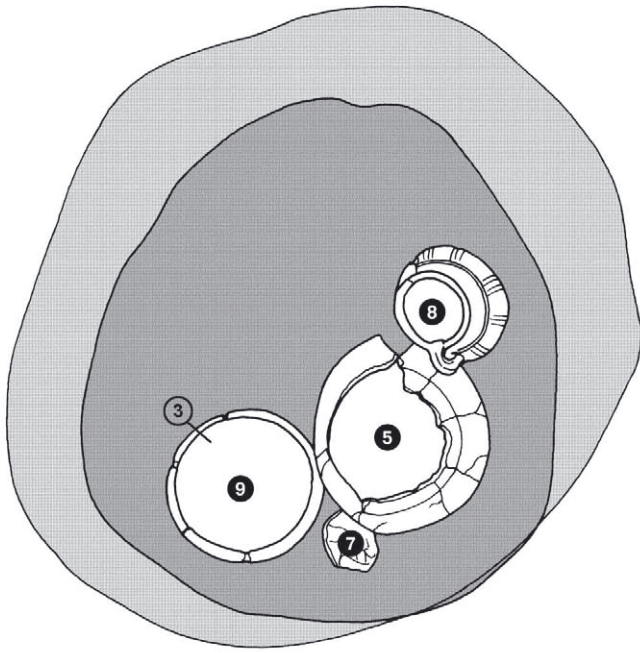

GRAB 580

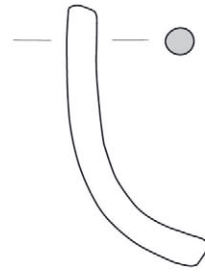

580/4

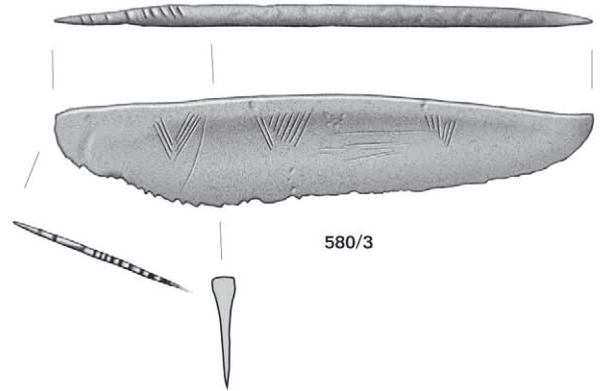

580/3

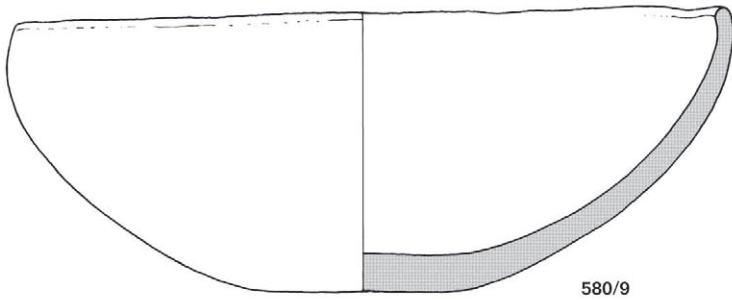

580/9

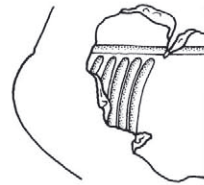

580/7

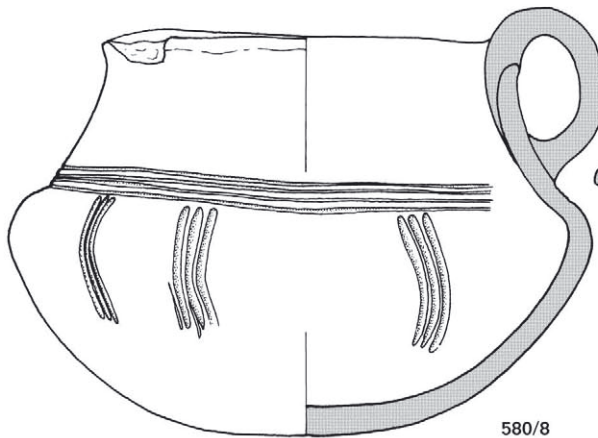

580/8

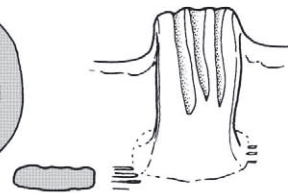

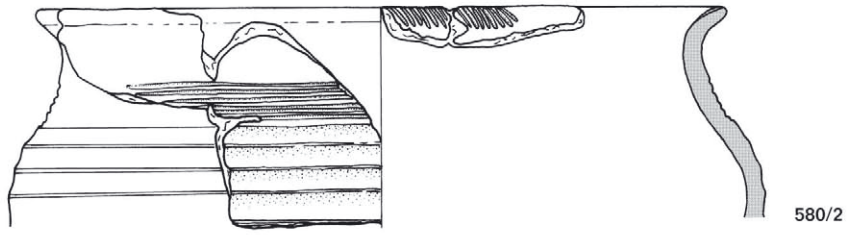

GRAB 580

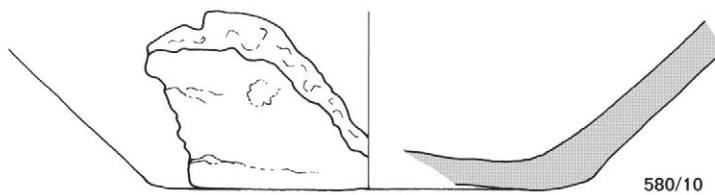
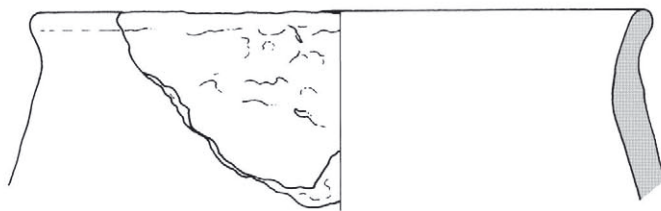
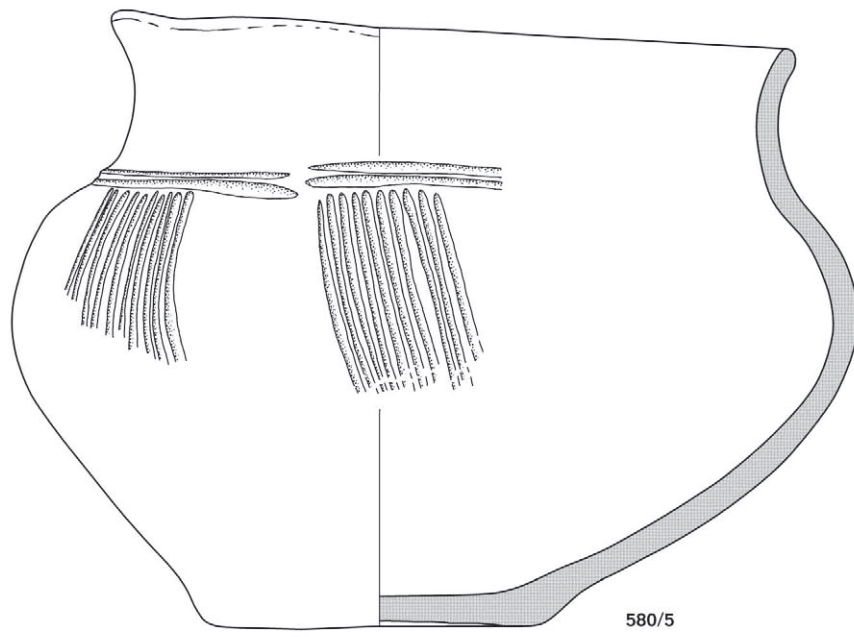

GRAB 581

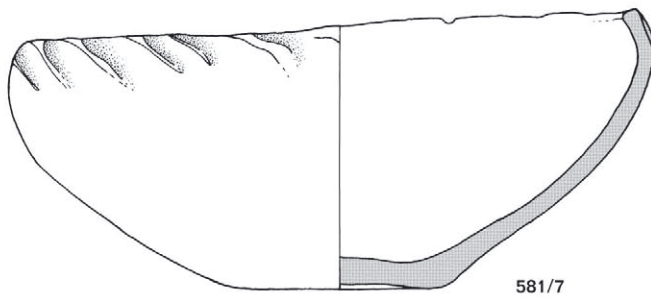
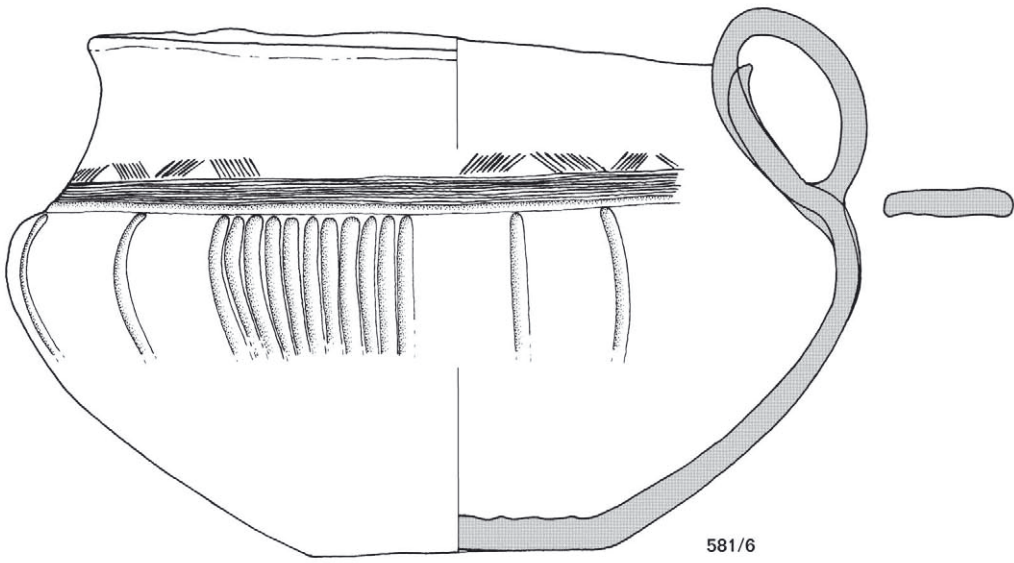
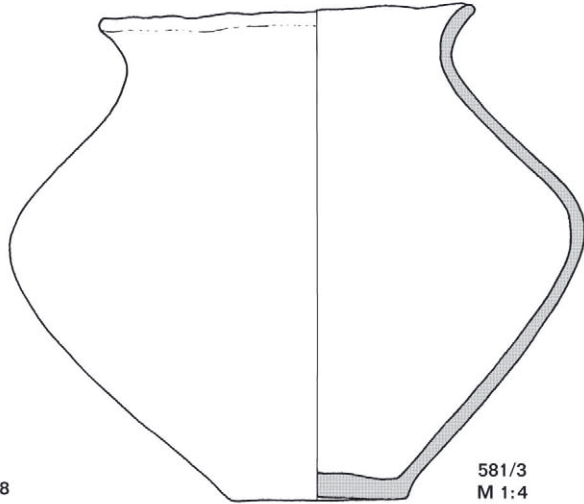
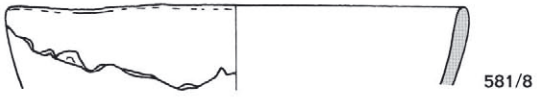
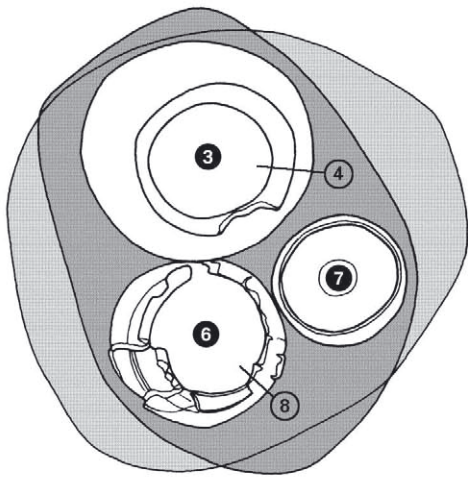

GRAB 581



581/9

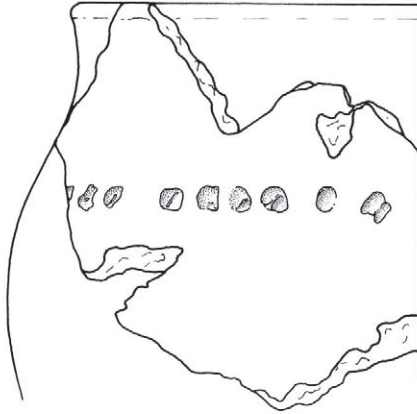

581/2

GRAB 583

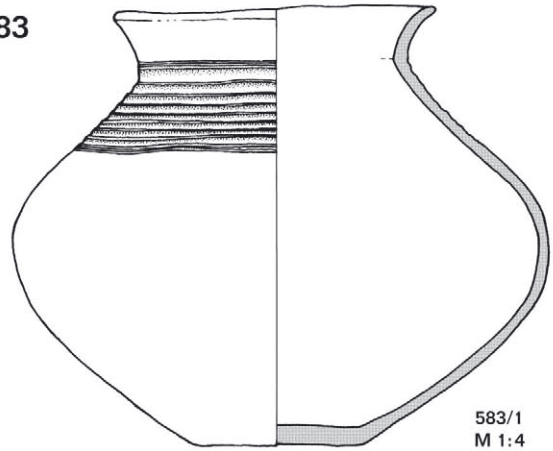
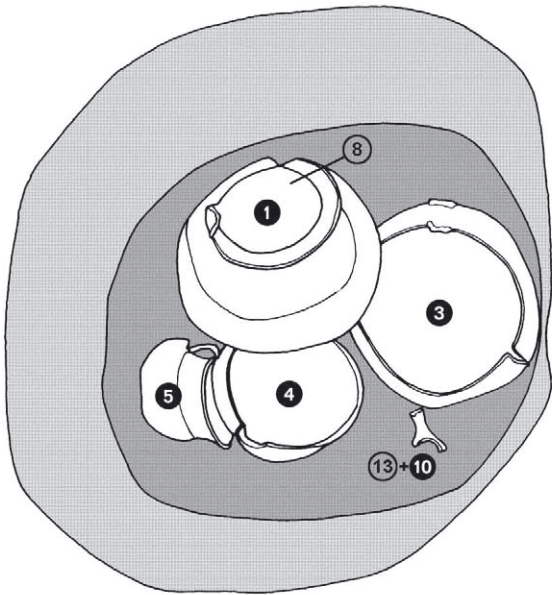

583/1
M 1:4

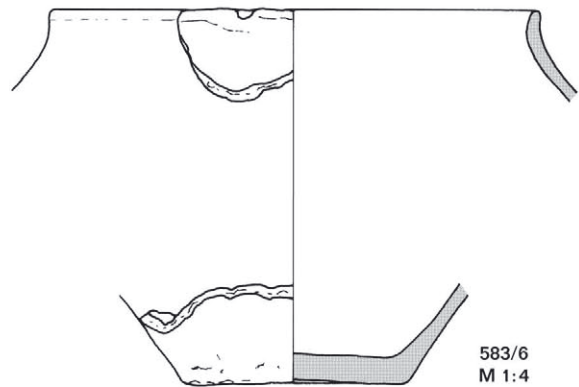

583/6
M 1:4

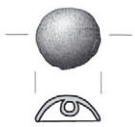

583/11

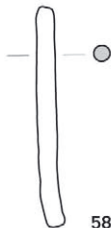

583/9